

MODEL: WF-W-971S-K

Assembly Instruction

TIPS: Before installation, please read the assembly instructions carefully.

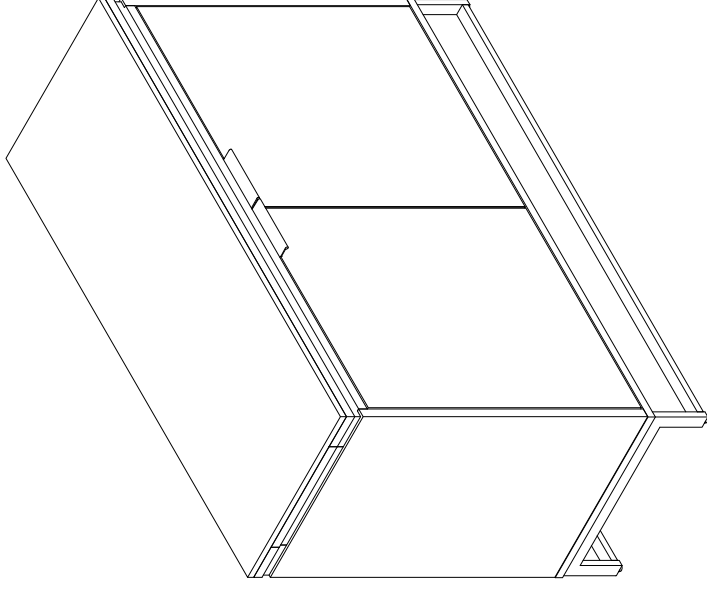

Clihome:
service@ali puinc.com
Browsing our website will bring you more surprises.
<https://clihome.net/>
303-747-4421

HARDWARE LIST:

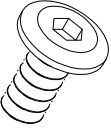
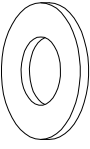
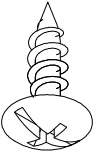
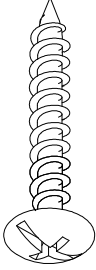
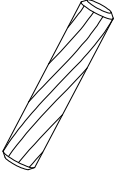
LABEL	PICTURE	DESCRIPTION	QTY
A		ALLEN KEY (φ4)	1PC
B		SCREW (M ^B *10)	16PCS
C		WASHER (φ16-φ6*1.5)	16PCS
D		SCREW (M ^A *12)	4PCS
E		SCREW (M ^A *40)	4PCS
F		WOOD PLUG (φ8*40)	20PCS

HARDWARE LIST:

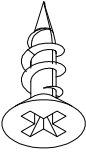
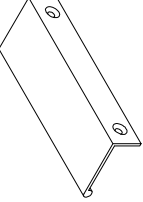
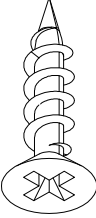
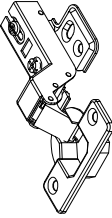
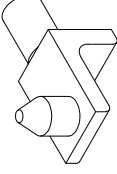
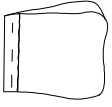
LABEL	PICTURE	DESCRIPTION	QTY
G		SCREW (M ^B .5*12)	4PCS
H		HANDLE (120*41*20)	2PCS
I		SCREW (M ^A *16)	24
J		INNER MASK HINGE (φ35-MAX)	4PCS
K		SHELF SUPPORT (26*16*9)	16PCS
L		TIPPING RESTRAIN	2PCS

PART LIST:

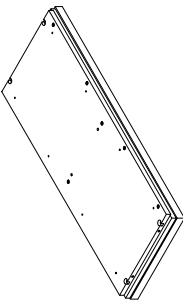
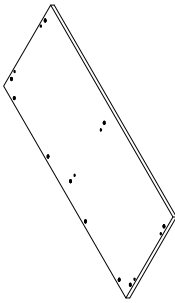
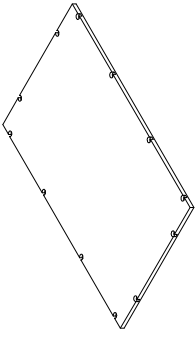
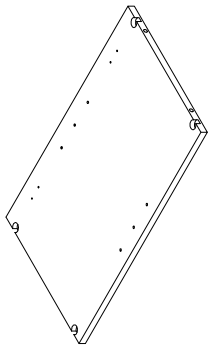
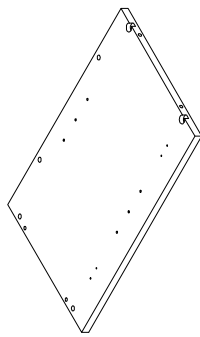
LABEL	PICTURE	DESCRIPTION	QTY
1		TOP PANEL	1PC
2		BOTTOM PANEL	1PC
3		BACK PANEL	1PC
4		MIDDLE SIDE PANEL	1PC
5		LEFT SIDE PANEL	1PC

PART LIST:

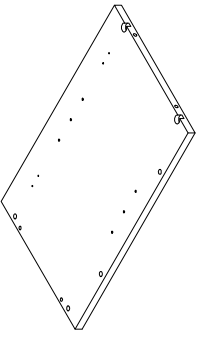
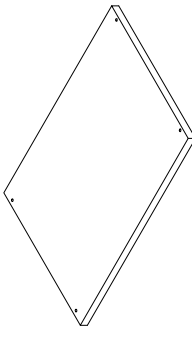
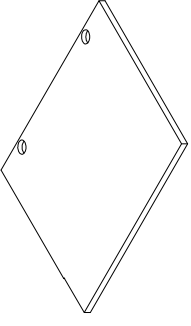
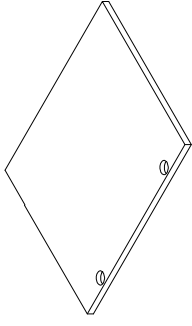
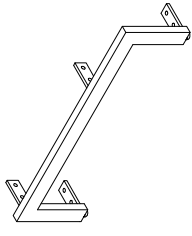
LABEL	PICTURE	DESCRIPTION	QTY
6		RIGHT SIDE PANEL	1PC
7		ADJUSTABLE SHELF	2PCS
8		LEFT DOOR	1PC
9		RIGHT DOOR	1PC
10		LEFT SIDE FRAME	1PC

PART LIST:

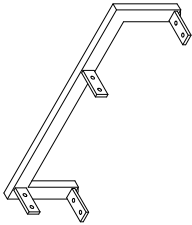
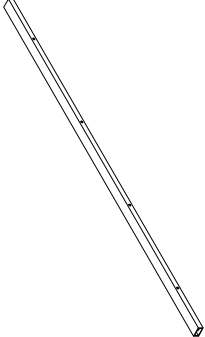
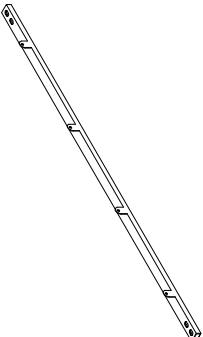
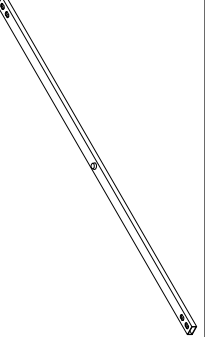
LABEL	PICTURE	DESCRIPTION	QTY
11		RIGHT SIDE FRAME	1PC
12		FRONT UP CONNECTING BAR	1PC
13		BACK UP CONNECTING BAR	1PC
14		BOTTOM CONNECTING BAR	2PCS
15			

PART LIST:

LABEL	PICTURE	DESCRIPTION	QTY



Assembly Instruction

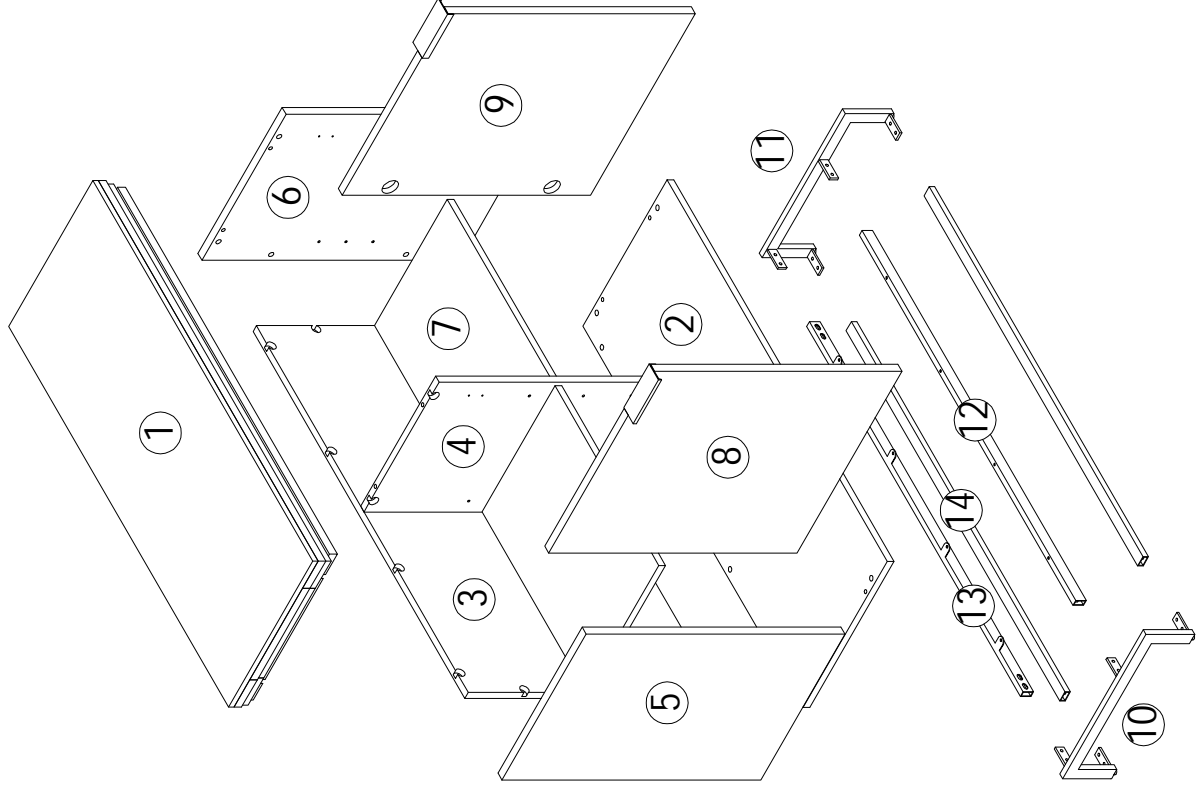
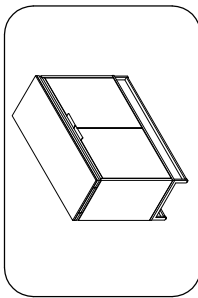
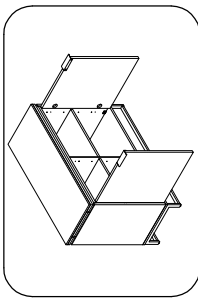
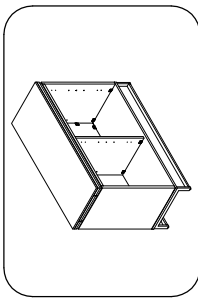
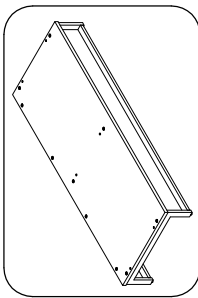
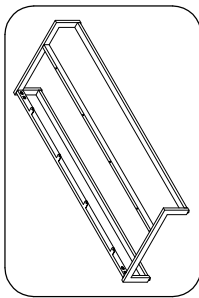

MODEL: WF-W-971S-K

EDITION: A

PART LIST:



LABEL	PICTURE	QTY
A		1PC
B		16PCS
C		16PCS

LABEL	PICTURE	QTY
D		4PCS
E		4PCS

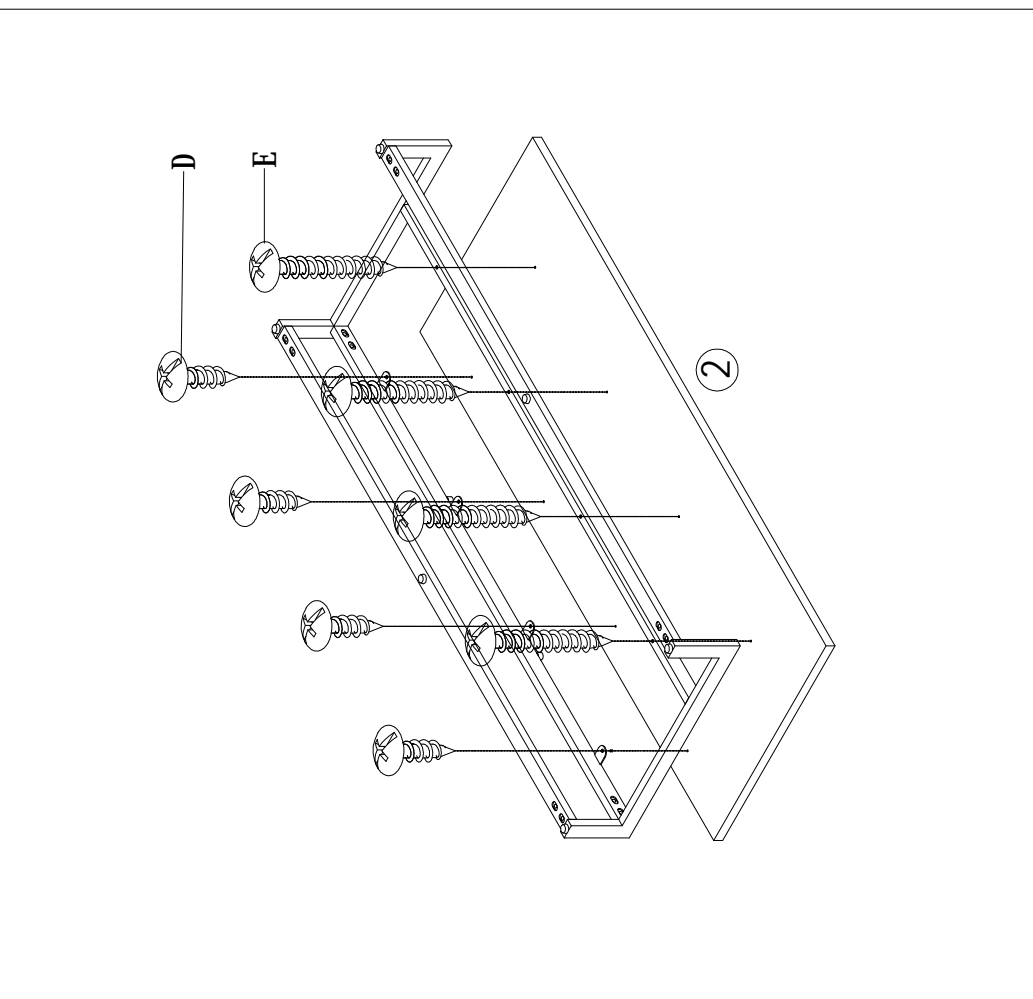
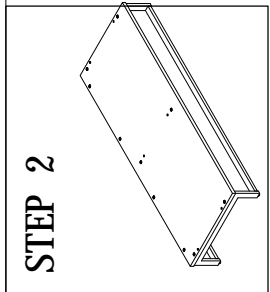
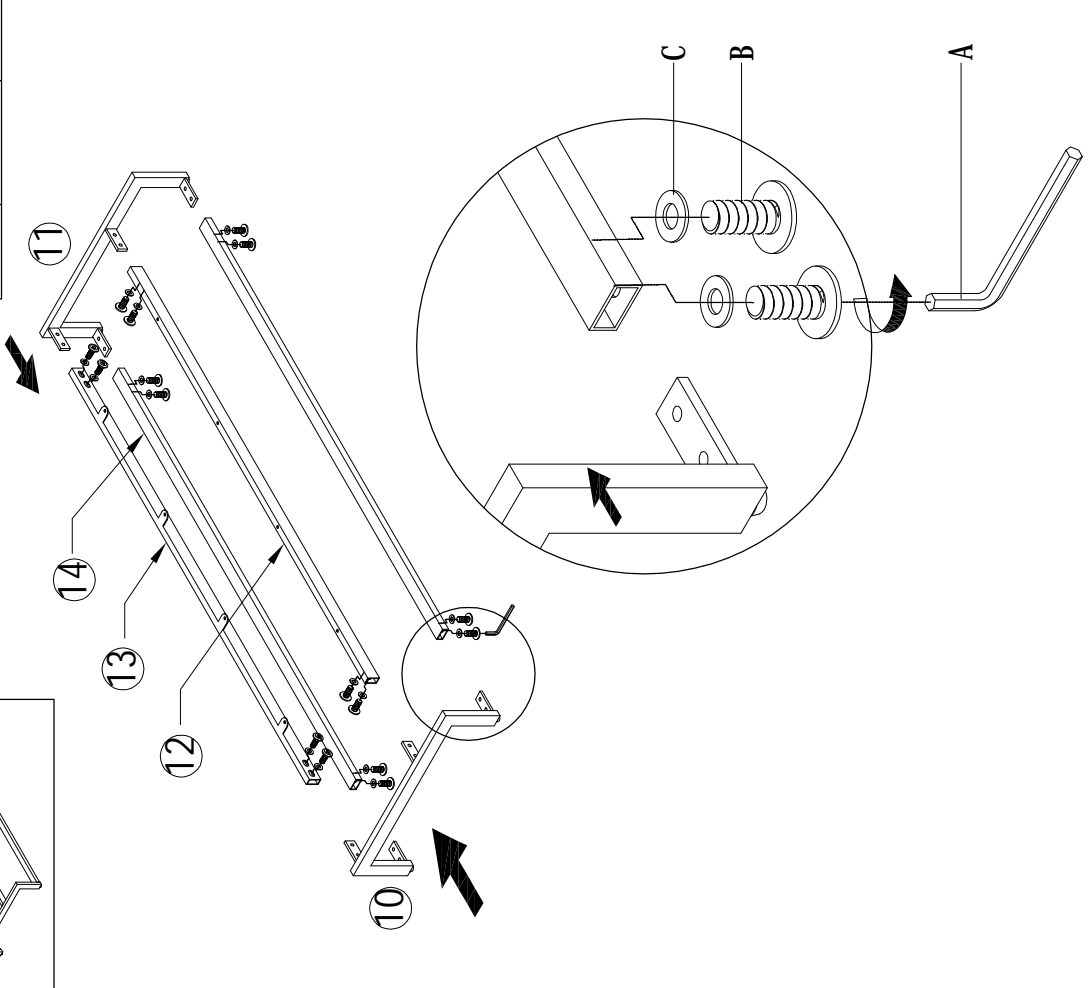
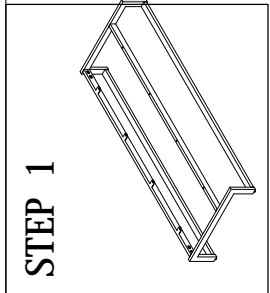

LABEL	PICTURE	QTY
F		6PCS

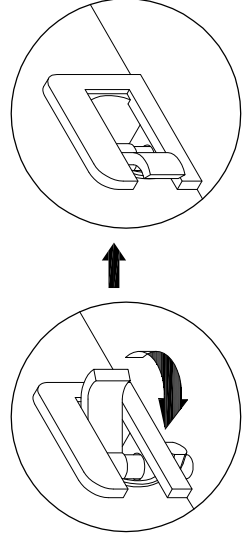
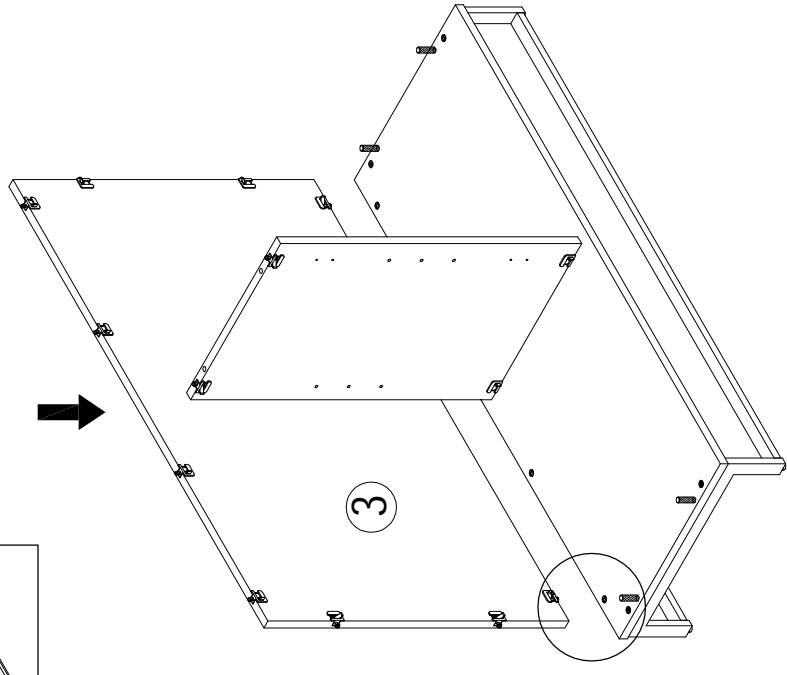
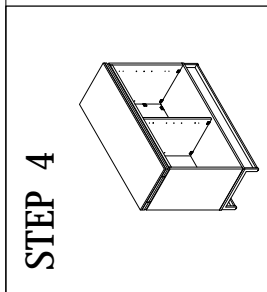
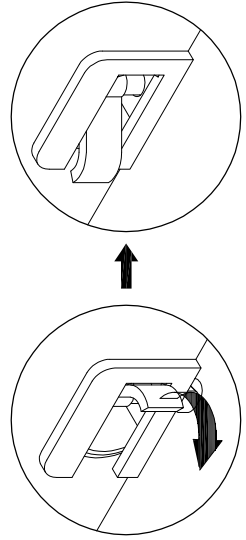
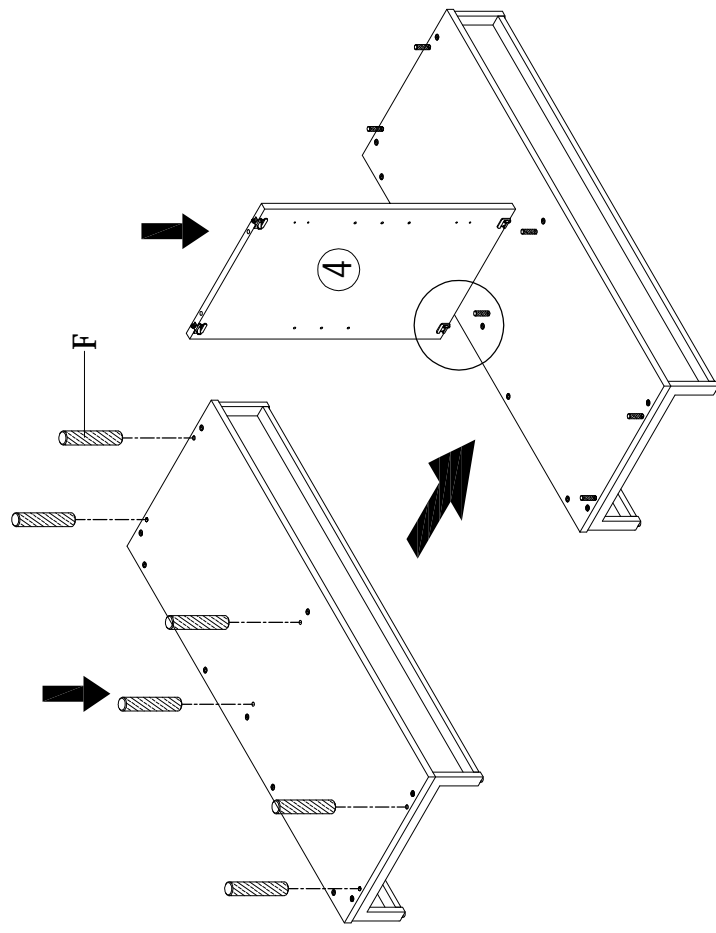
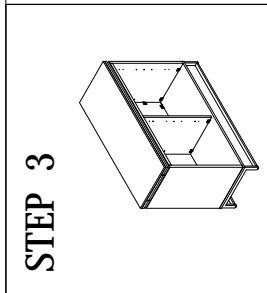

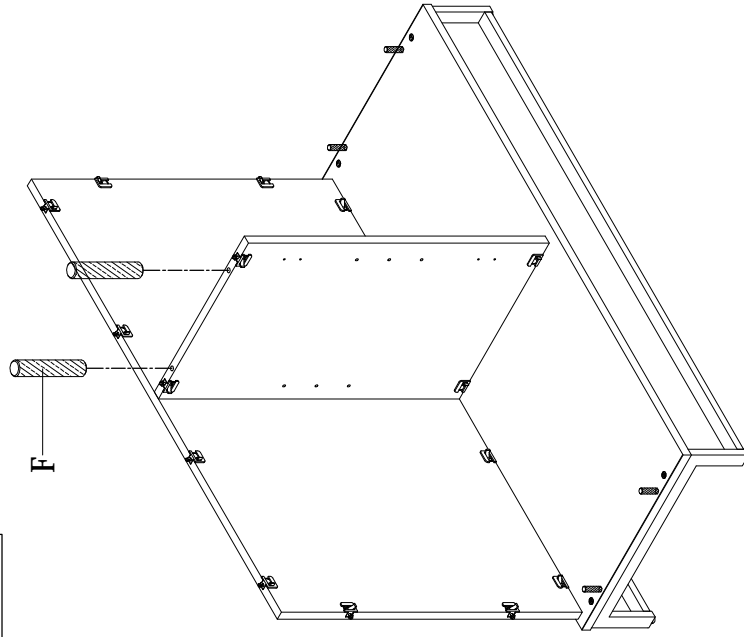
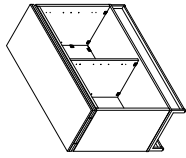

STEP 5

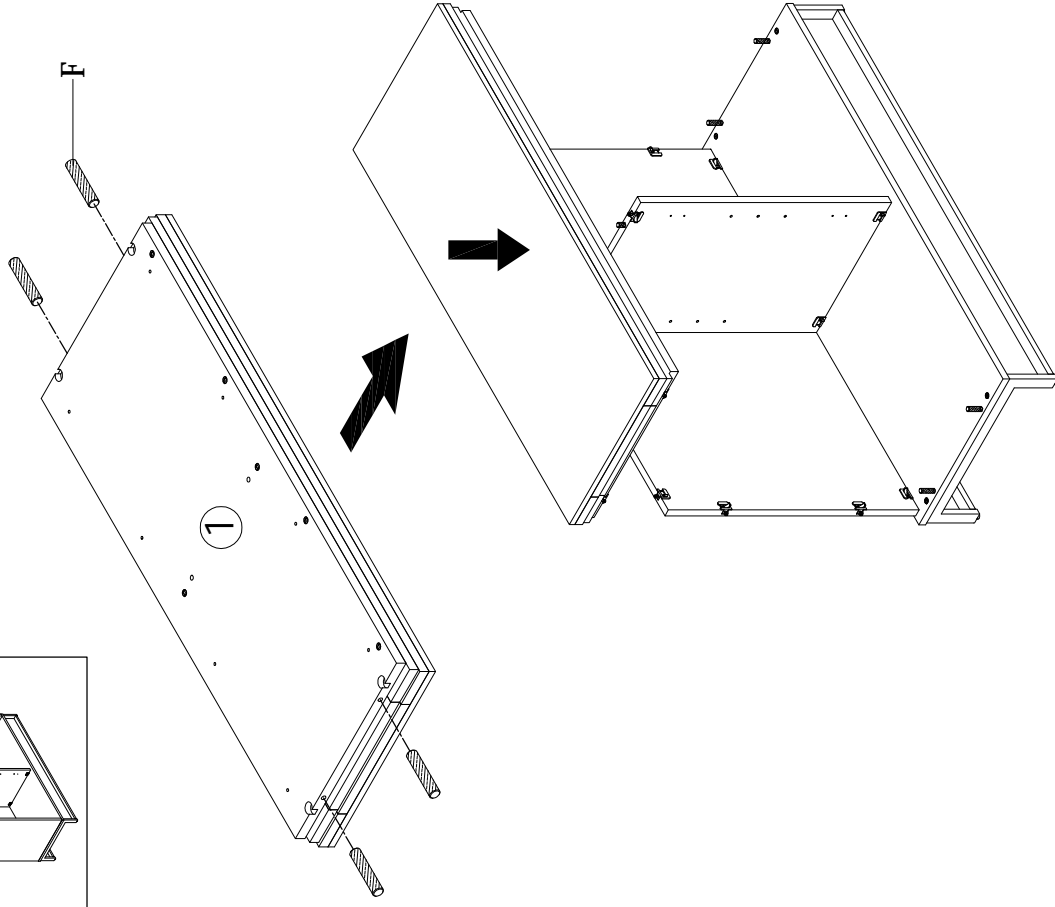
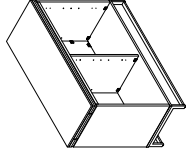

LABEL	PICTURE	QTY
F		2PCS

STEP 6



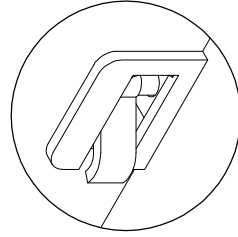
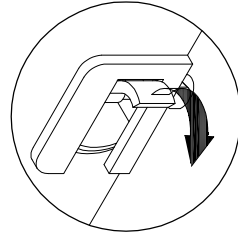
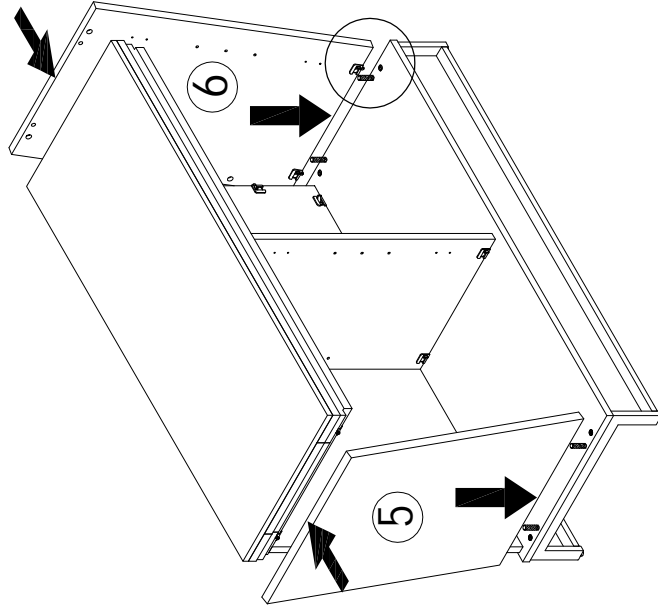
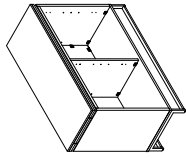

LABEL	PICTURE	QTY
F		4PCS

STEP 7



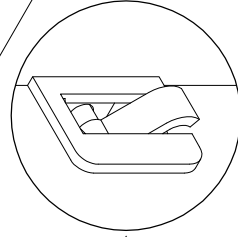
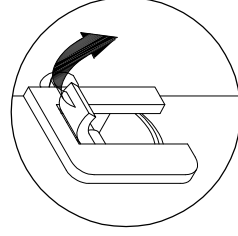
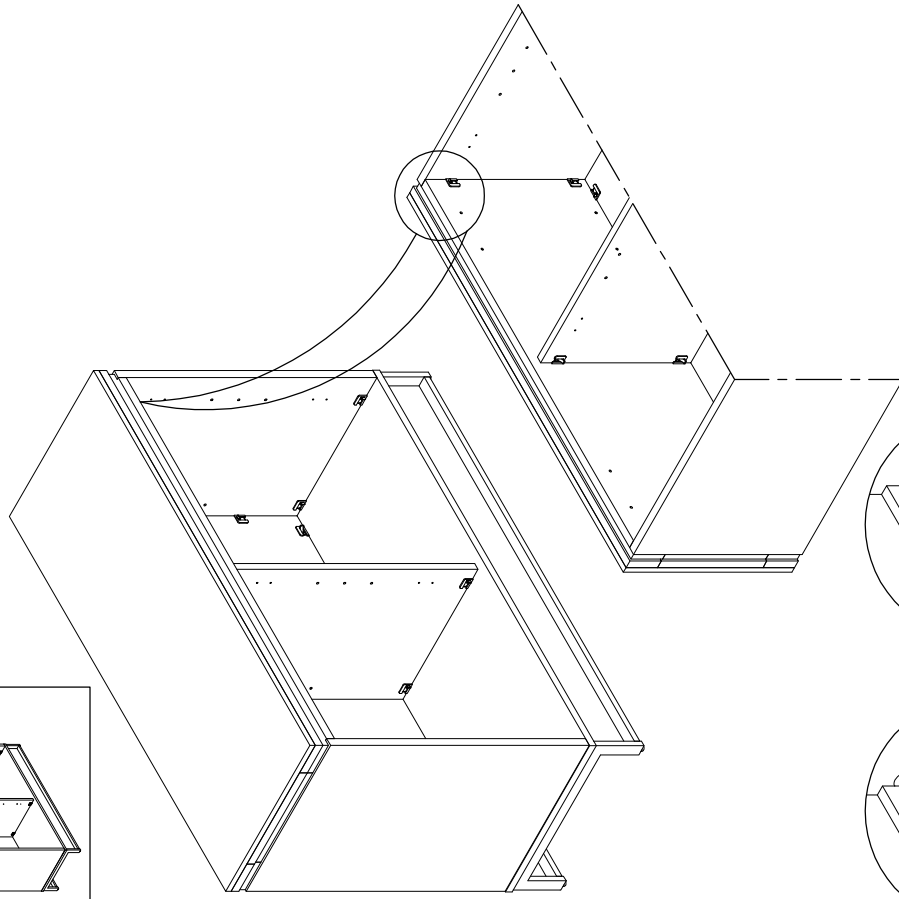
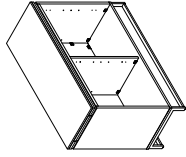

STEP 8

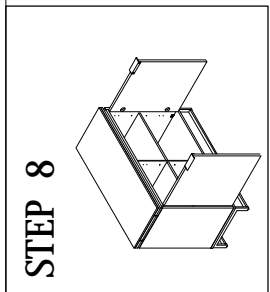
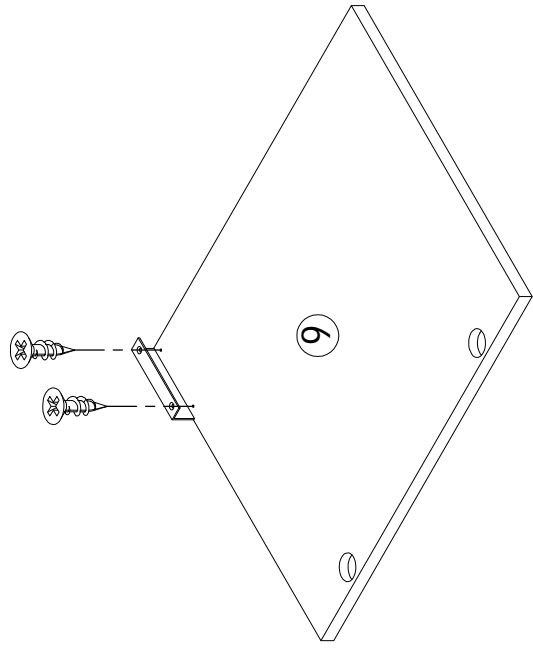
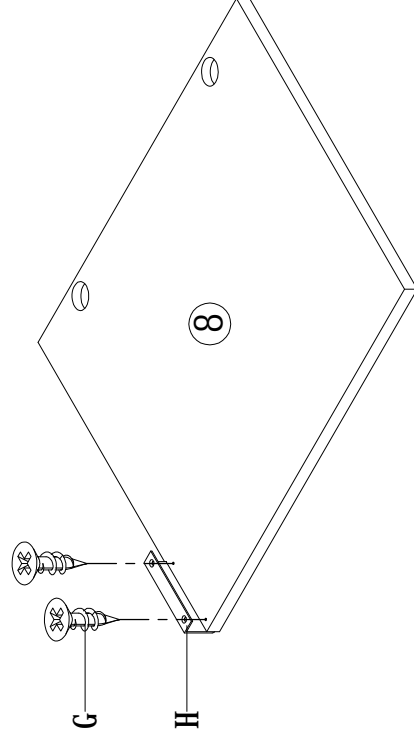
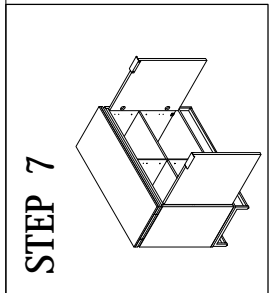

LABEL	PICTURE	QTY
G		4PCS
H		2PCS



LABEL	PICTURE	QTY
I		16PCS
J		4PCS

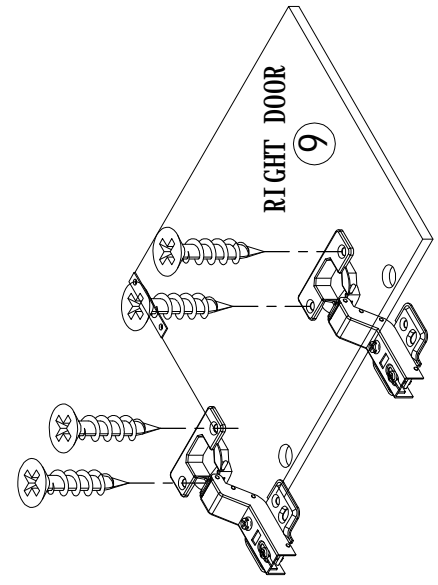
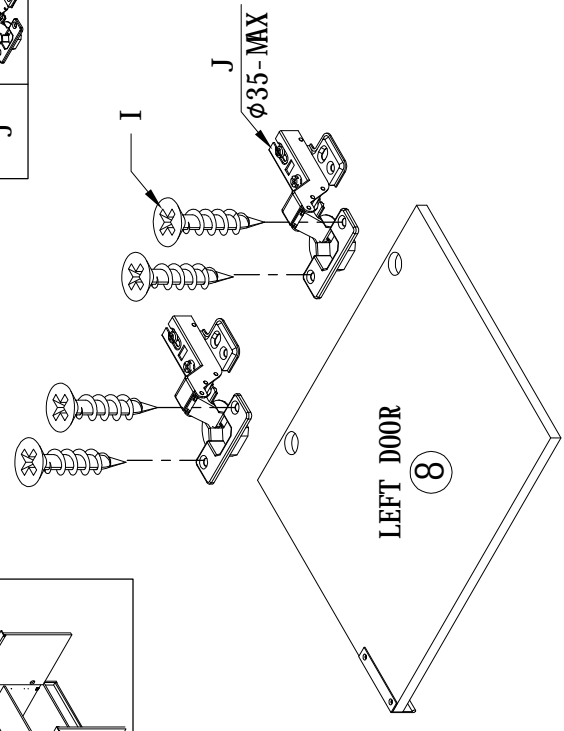

STEP 9

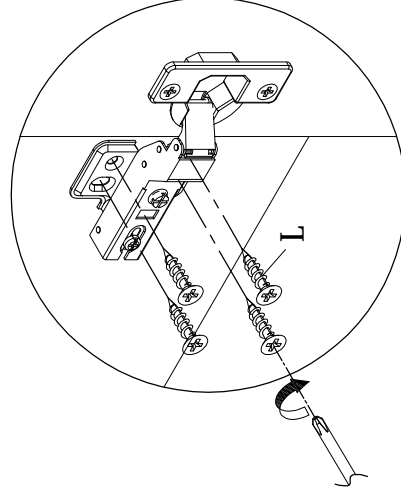
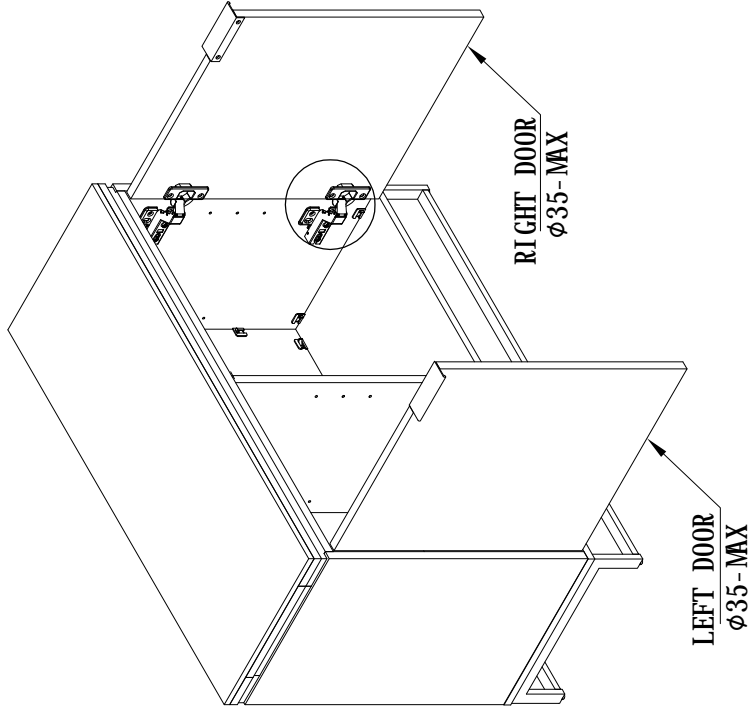
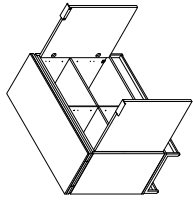

LABEL	PICTURE	QTY
L		16PCS

DOOR FITTING

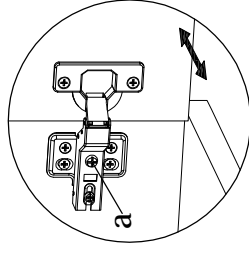

To adjust in width

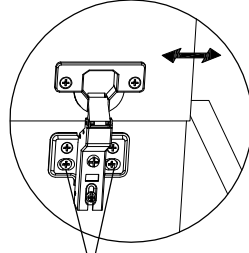

To adjust in height

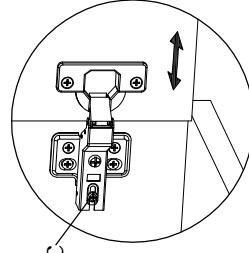

To adjust in depth

STEP 10

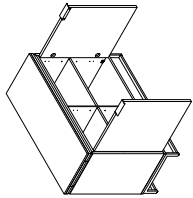

LABEL	PICTURE	QTY
K		8PCS

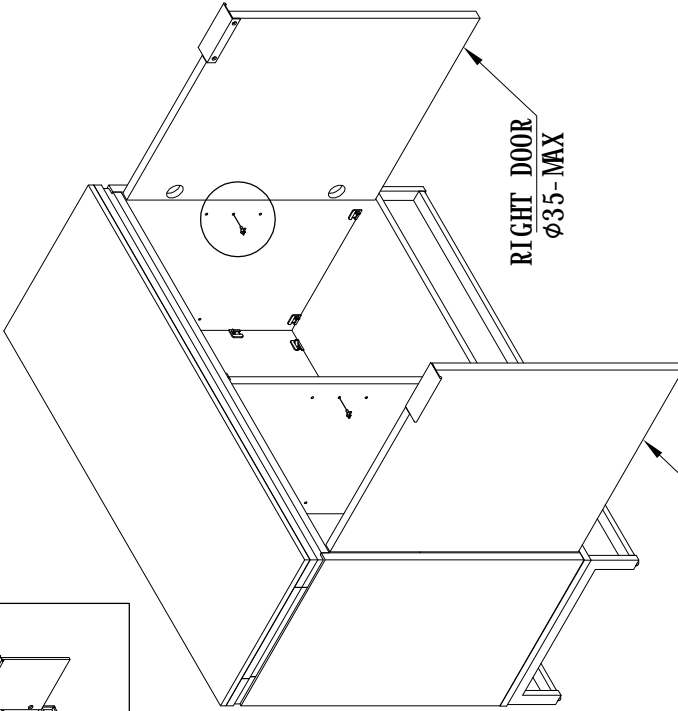

LEFT DOOR
φ35-MAX

RIGHT DOOR
φ35-MAX

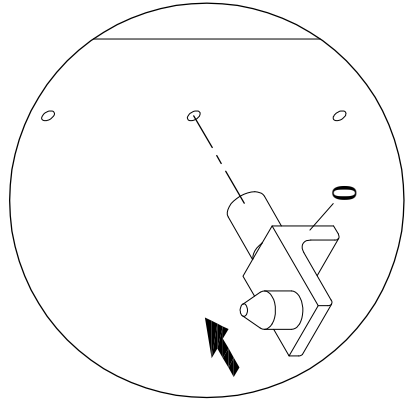

STEP 11

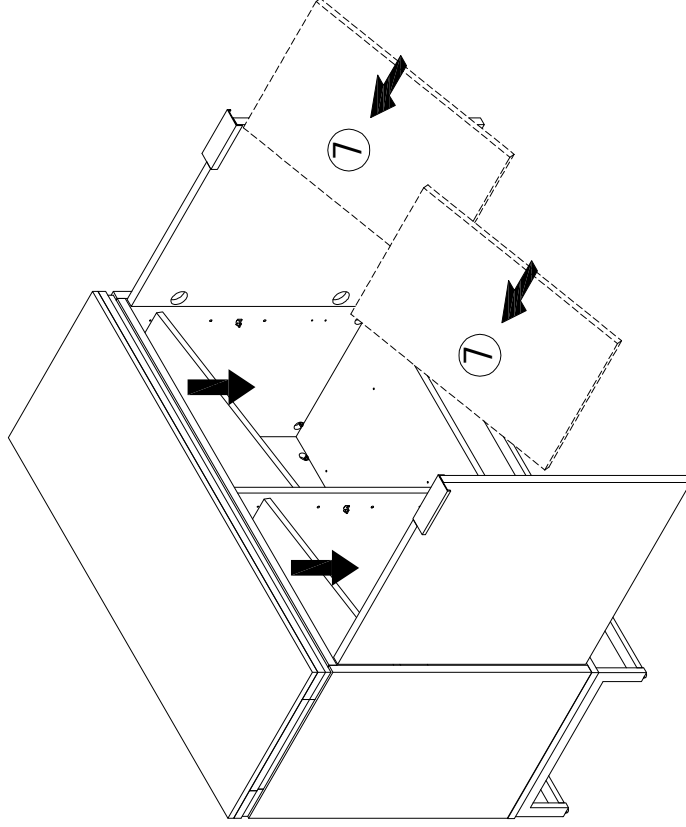
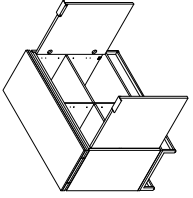

STEP 12

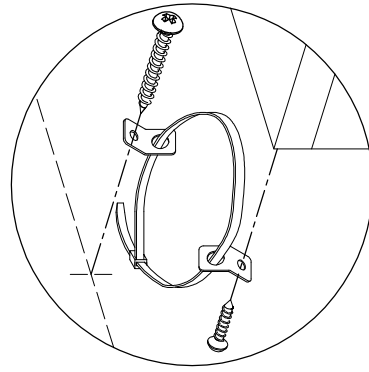
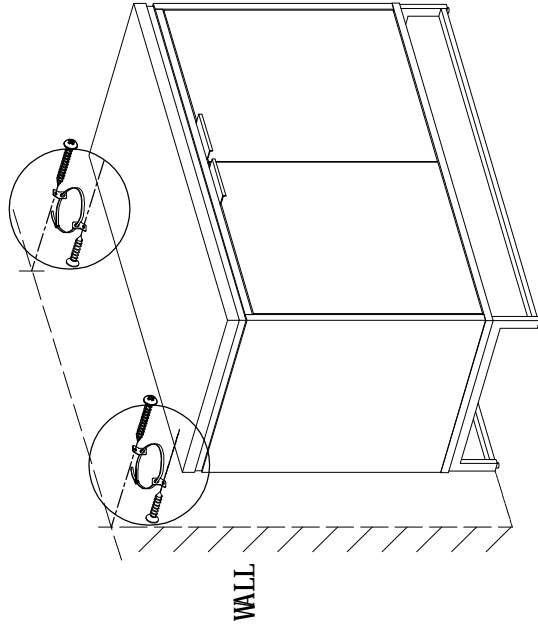
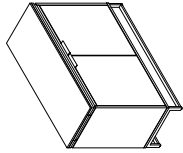

ANTI-TIP KIT INSTALLATION

STEP 13

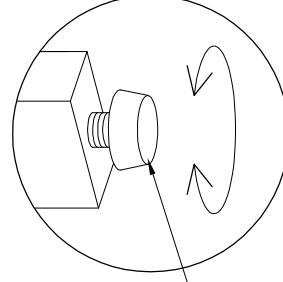
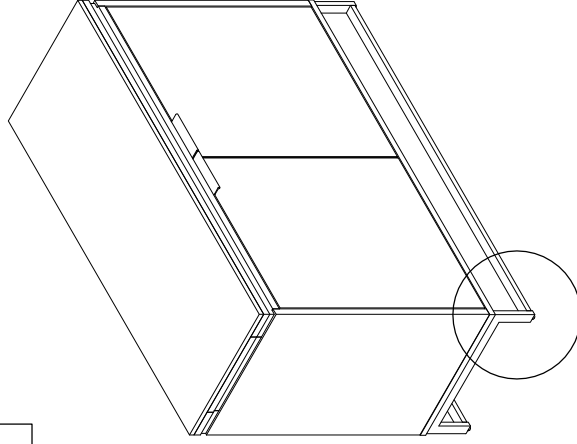
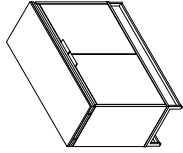

ADJUSTABLE LEVELERS

To ensure the unit is level on the floor, please use the adjustable leveler on the bottom of each leg.