

## 8' x 5' Grill Gazebo\_16087 Assembly Instructions











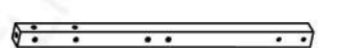
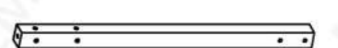







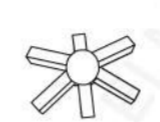

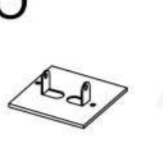
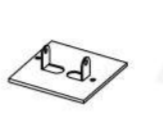





### Notification

1. We care about your shopping experience, kindly contact us freely if any part missing or defective or any other issue, we will try our best to solve it asap.
2. Recommend at least 2 persons and prepare a ladder to assemble the gazebo.

-1-

### Parts List

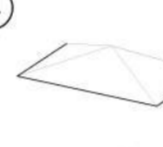
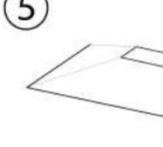
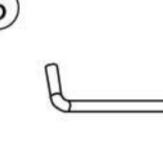
<b>A</b>  4PCS	<b>B</b>  1PC	<b>C</b>  1PC
<b>D</b>  2PCS	<b>E</b>  4PCS	<b>F</b>  2PCS
<b>G</b>  4PCS	<b>H</b>  2PCS	<b>I</b>  2PCS
<b>J</b>  1PC	<b>K</b>  4PCS	<b>L</b>  1PC
<b>M</b>  4PCS	<b>N</b>  4PCS	<b>O</b>  4PCS
<b>P</b>  4PCS	<b>Q</b>  2PCS	<b>R</b>  2PCS
<b>S</b>  1PC	<b>T</b>  8PCS	<b>U</b>  1PC
<b>V</b>  M6*15 38PCS	<b>W</b>  M6*20 8PCS	<b>X</b>  M6*25 6PCS
<b>Y</b>  M6*30 10PCS	<b>Z</b>  18PCS	<b>①</b>  1PC
<b>②</b>  1PC	<b>③</b>  8PCS	<b>④</b>  1PC
<b>⑤</b>  1PC	<b>⑥</b>  8PCS	

-2-

### STEP 7

Assemble double-tiered canopy.

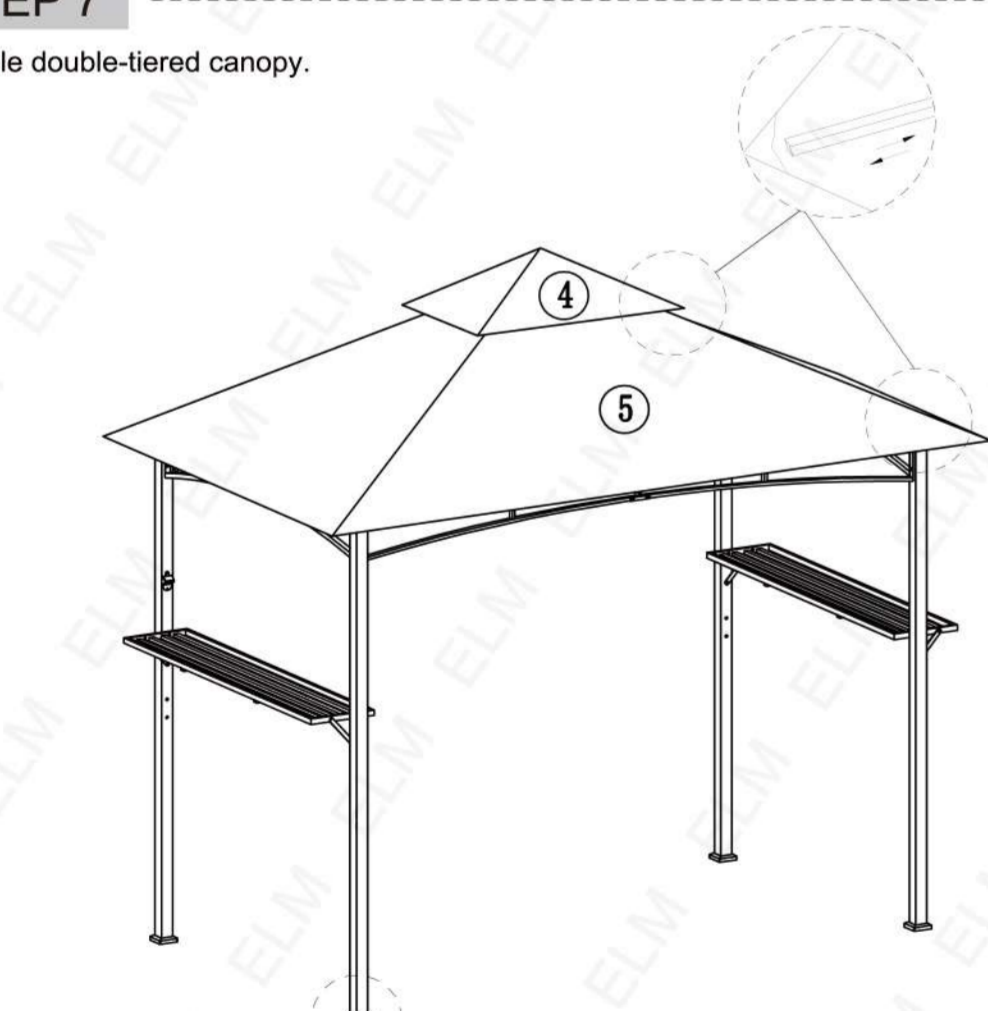

Fix the gazebo to the ground with part ① when on the grass, use screw T when on the wooden floor, use expansion screw ③ when on the cement.

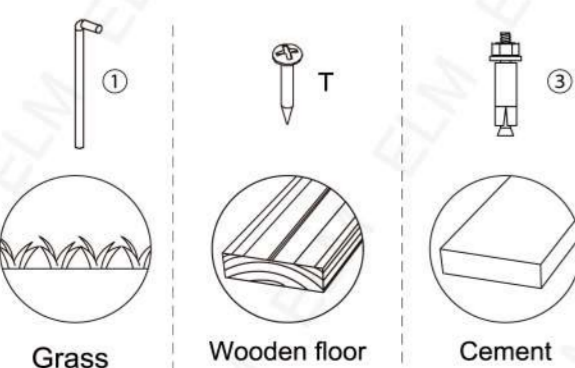

-6-

### STEP 1

Insert the part N, connect pole A and part O with bolt V, then put down the part N.

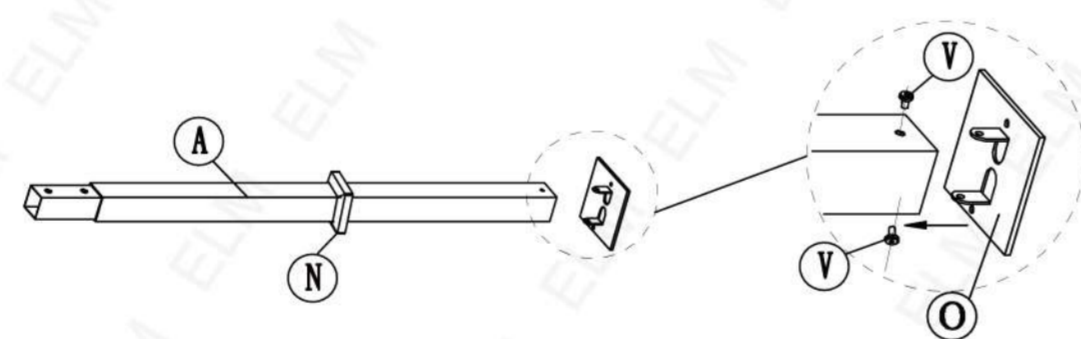

### STEP 2

Assemble the part P with pole B, C, D by bolt V, connect pole A and B, C, D with bolt V, assemble the part U with bolt V.

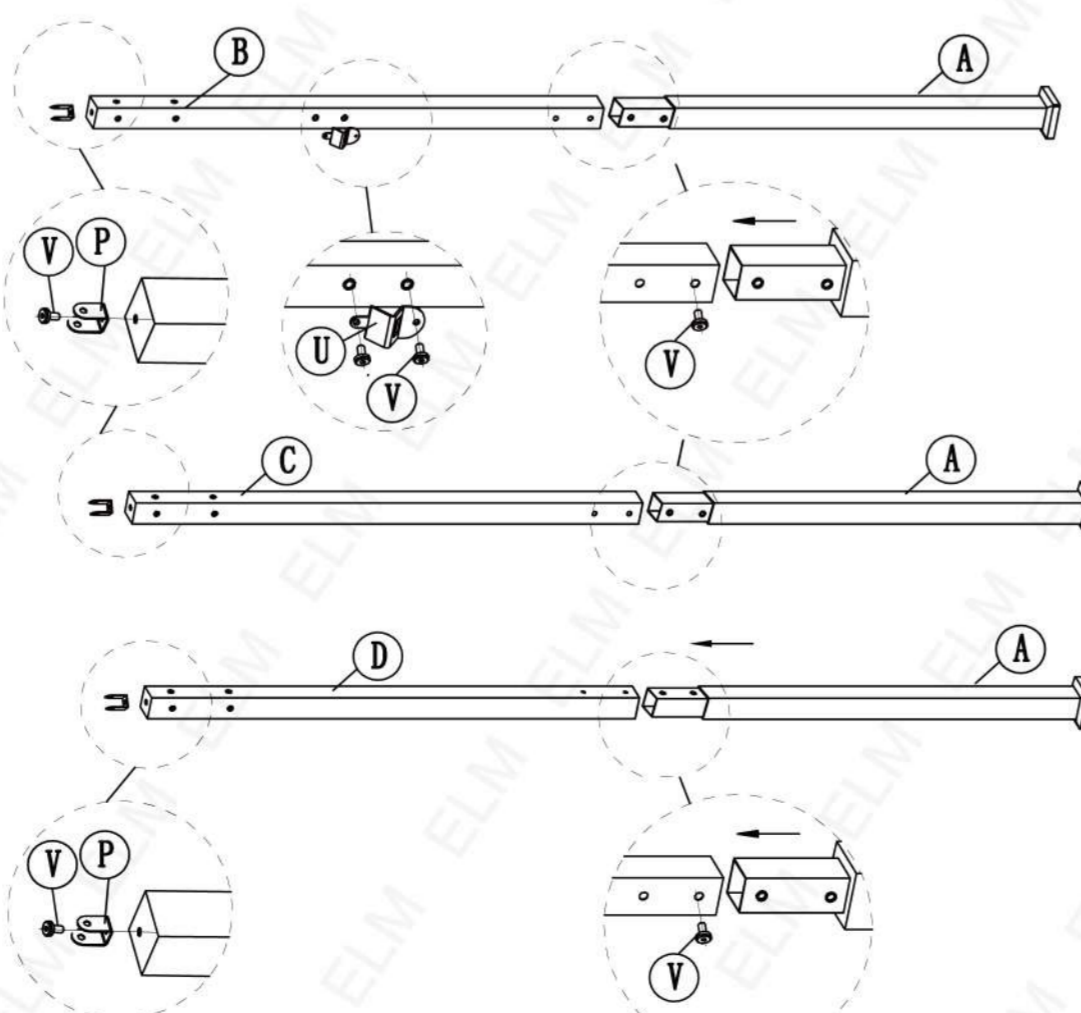

-3-

### STEP 3

Connect part E with bracket Q, R by bolt Y and nut Z.

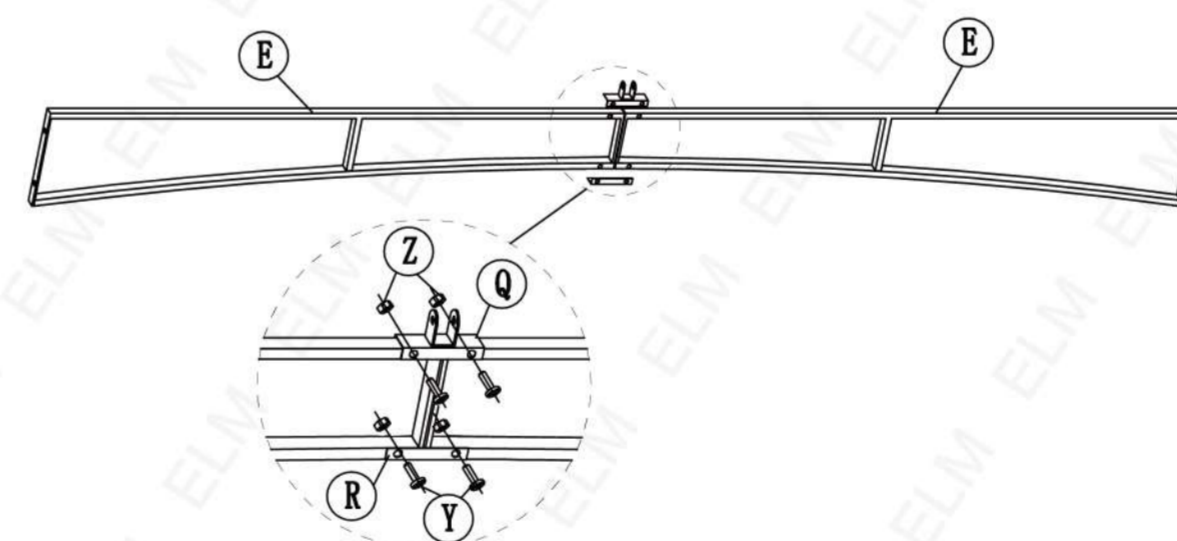

### STEP 4

1. Connect the frame E, F with bottom pole by bolt V.
2. Connect two shelves I with bottom pole by supporting bracket M, bolt V, W and nut Z.
3. Assemble the hook J with bolt Y.

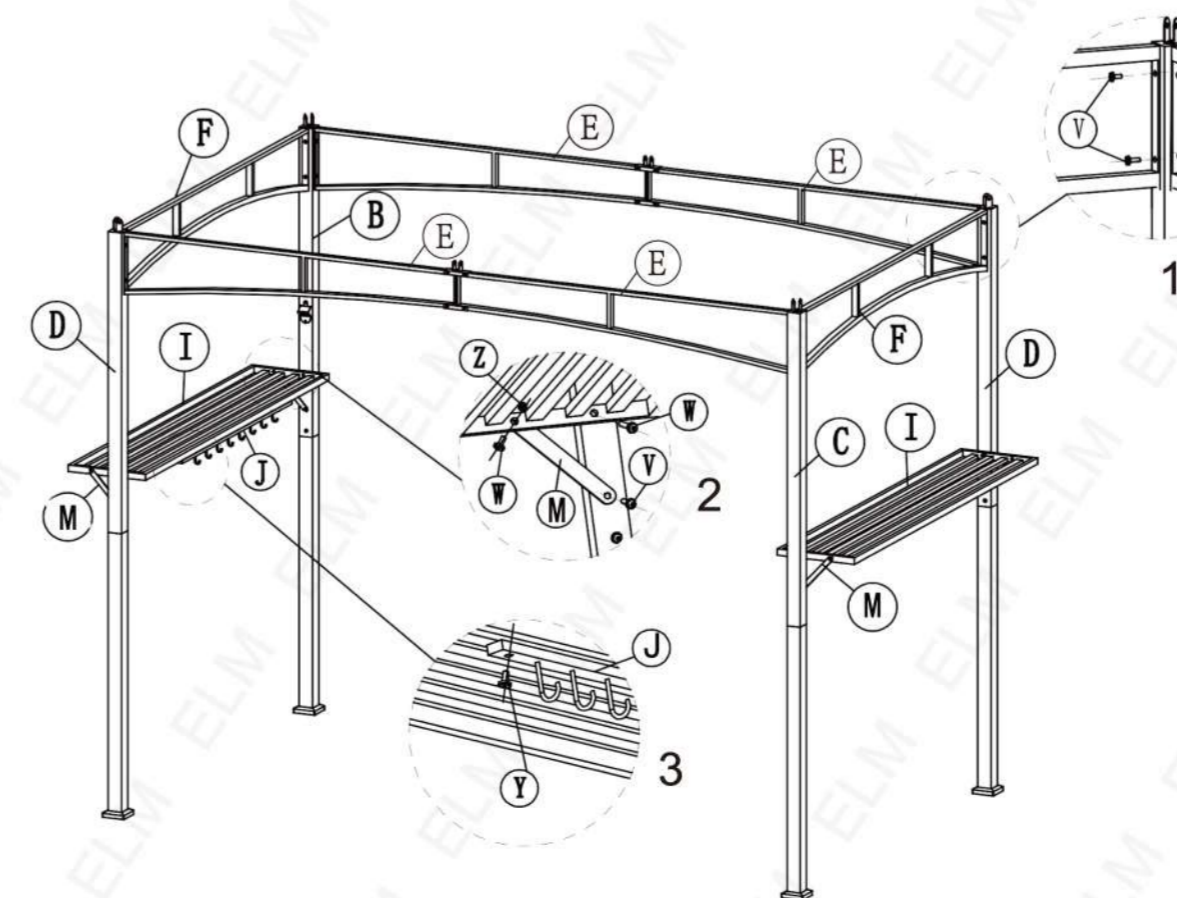

-4-

### STEP 5

1. Insert all part G, K in turn and tube H into center frame L and make sure connected firmly.
2. Connect the hook S with L.

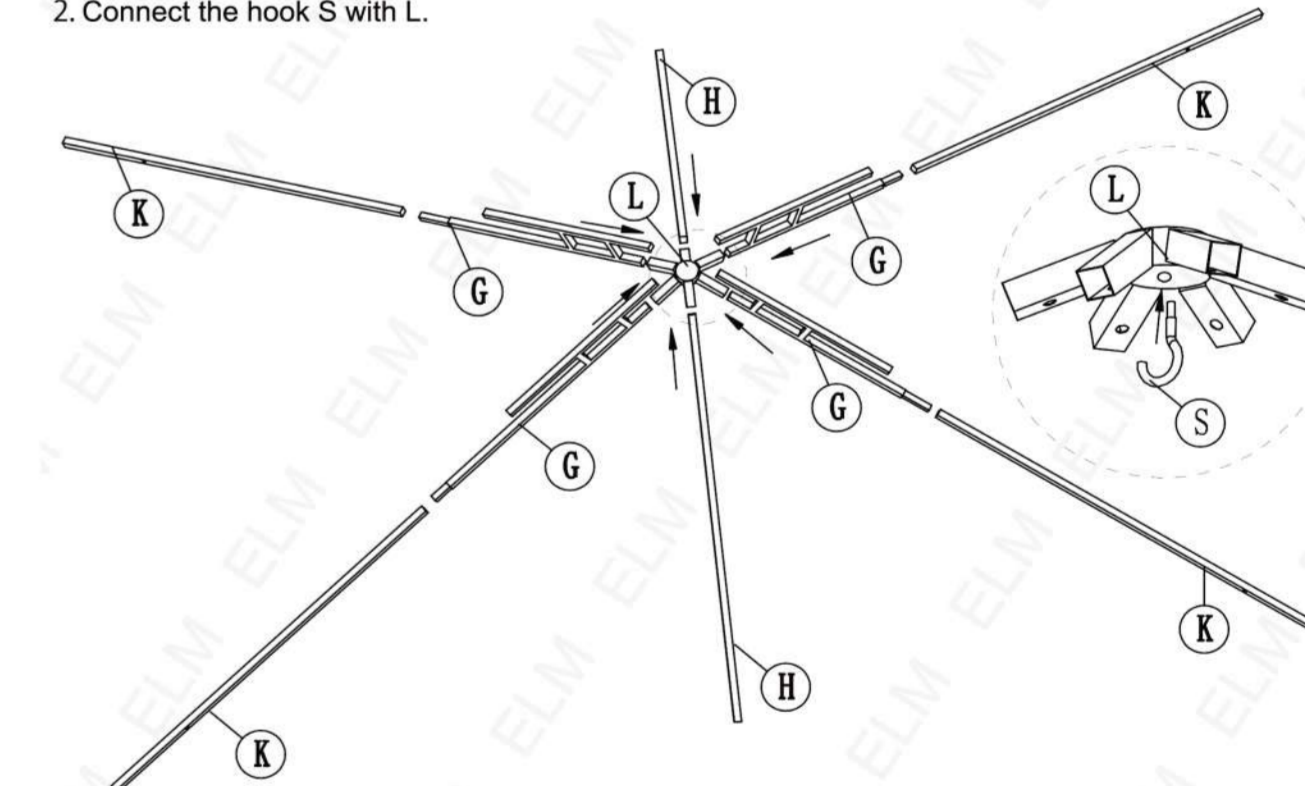

### STEP 6

Connect roof frame with base frame with bolt X and nut Z.

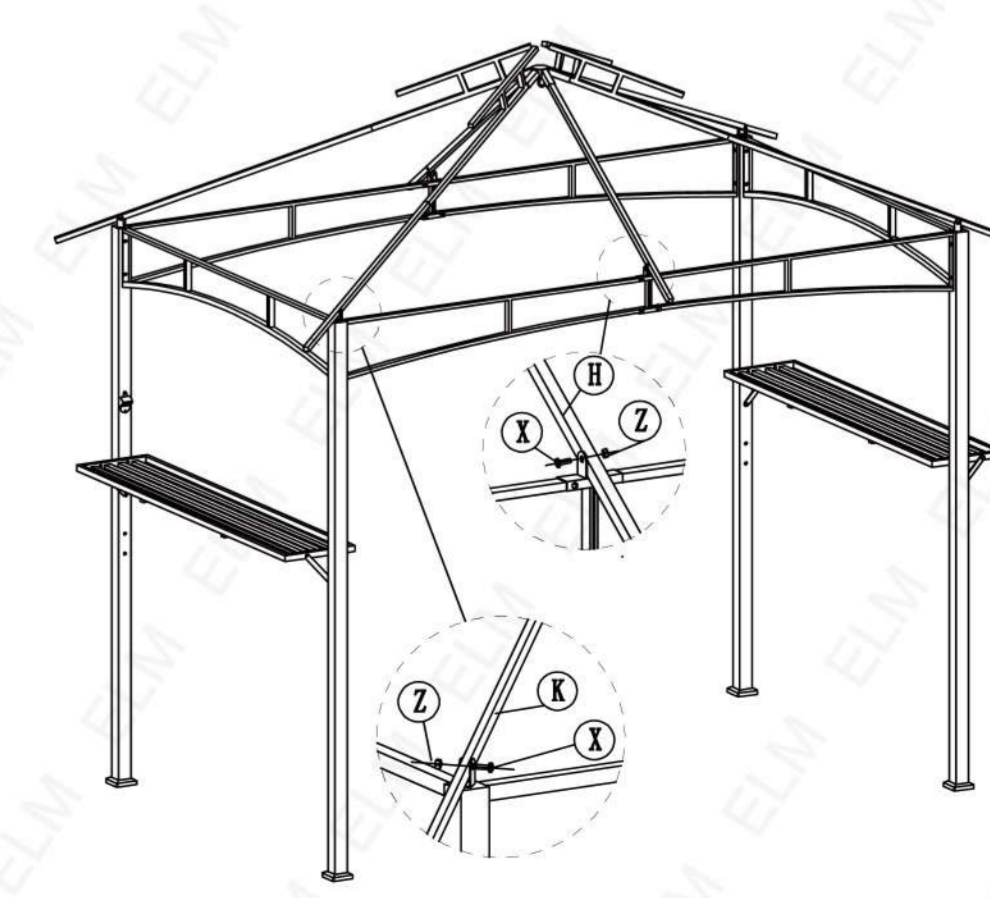

-5-