















Assembly Instruction

BOX-A			
NO.	DRAWING	QTY	DESCRIPTION
A1		1	LSF SEAT
C1		1	LSF ARM
D1		1	LSF EAR
BOX-B			
A2		1	RSF SEAT
C2		1	RIGHT ARM
D2		1	RIGHT EAR
BOX-C			
B		2	BACK REST
H		2	CONNECTOR
I		8	NUT
J		4	PLASTIC PAD
K	 M6x30	8	SCREW
L		1	ALLEN KEY
BOX-D			
E		1	CONSOLE BACK REST
F		1	CONSOLE

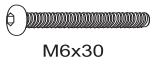
STEP 1

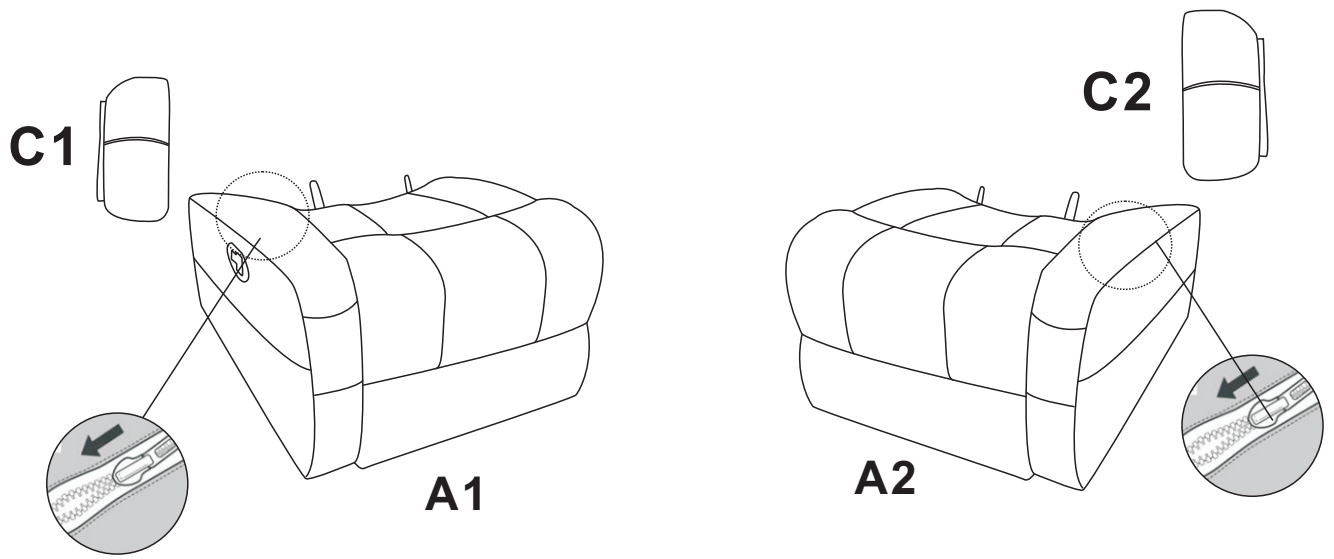

STEP 2

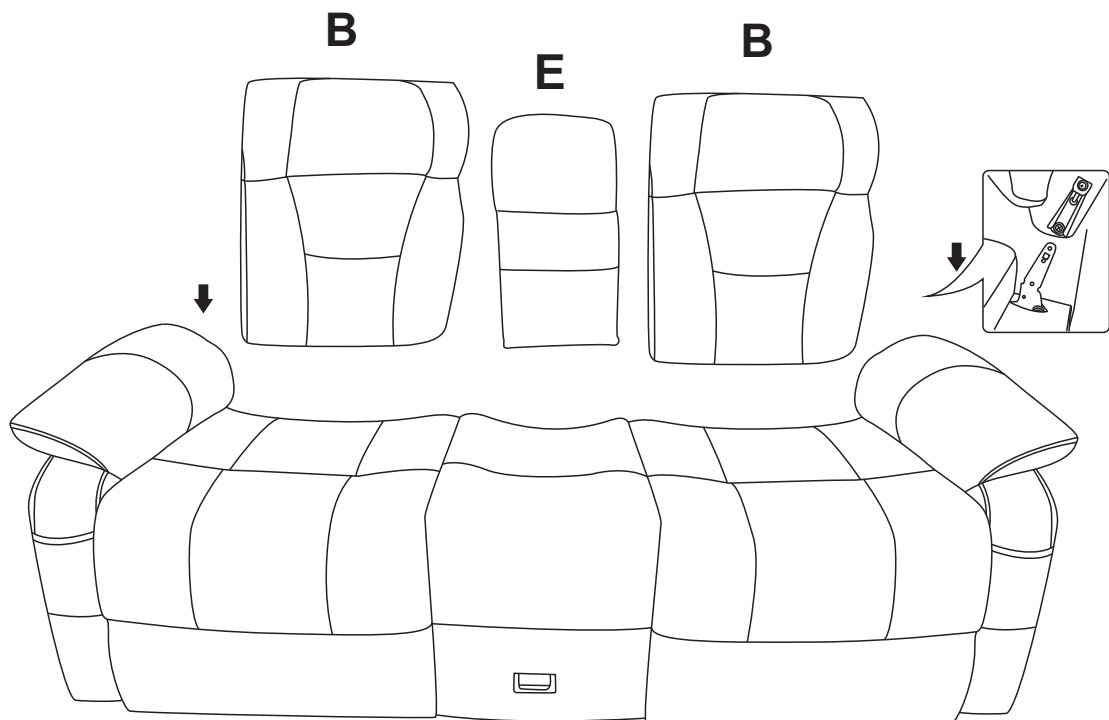

STEP 3

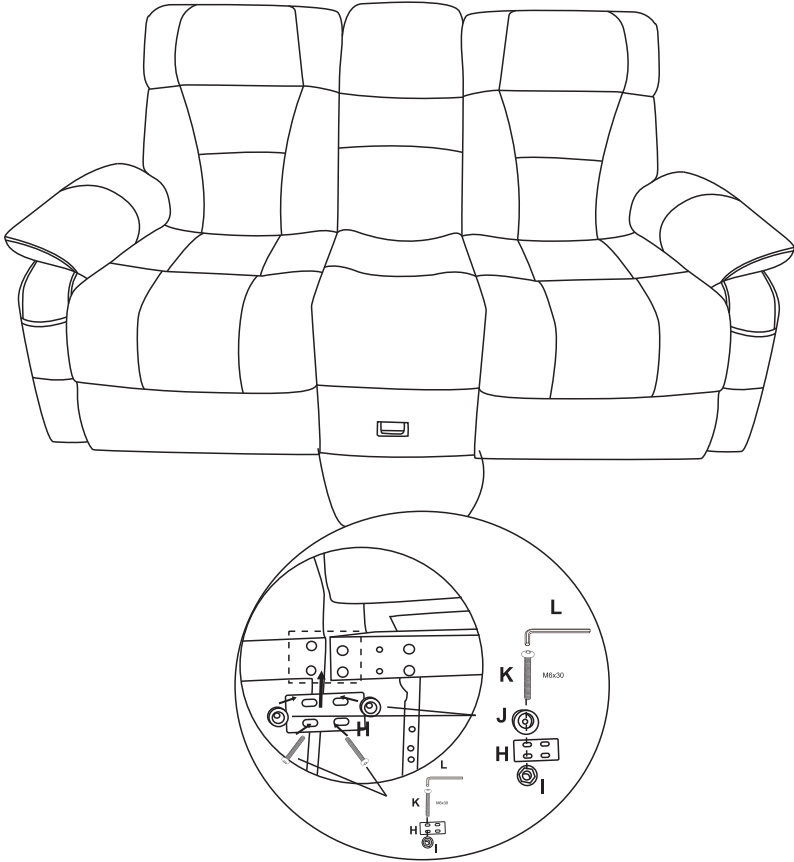



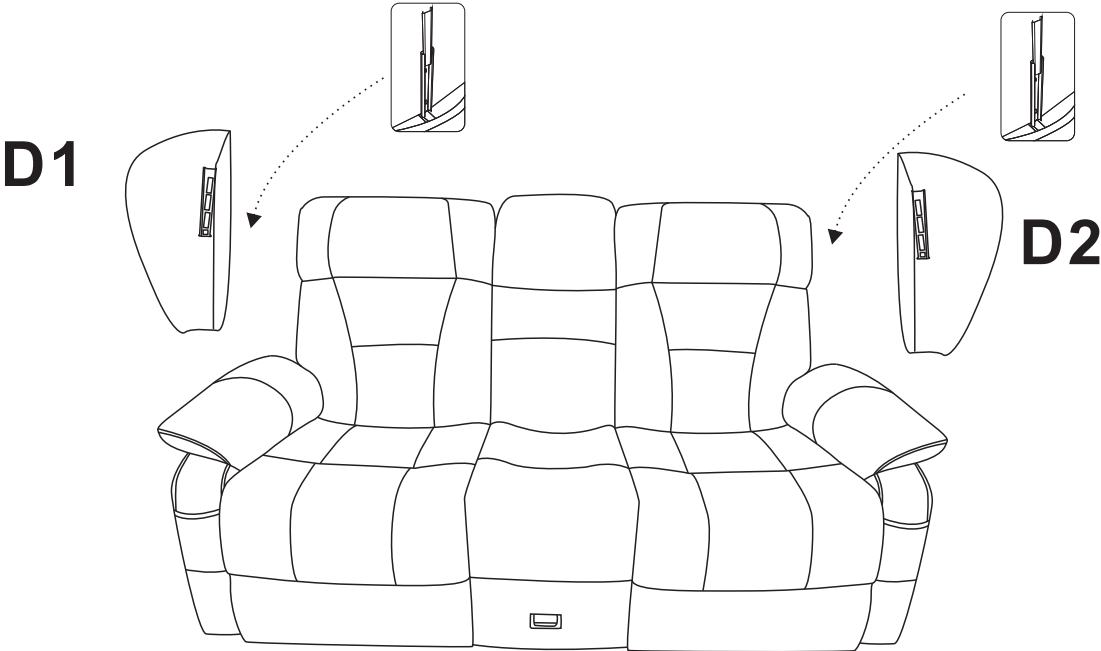



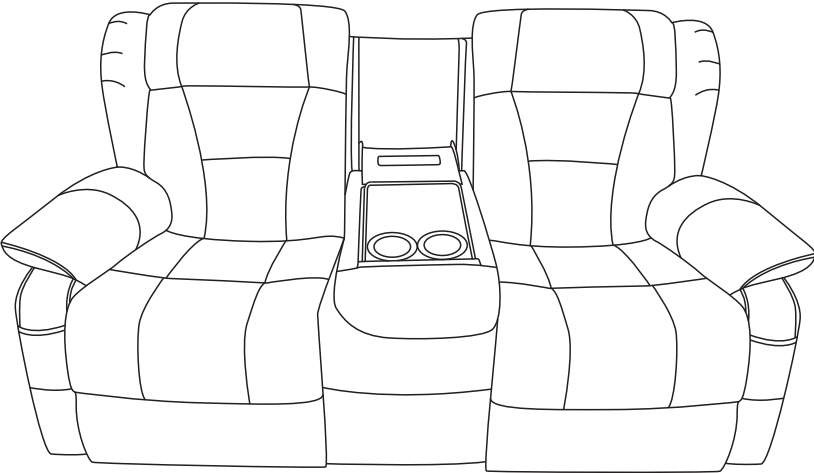
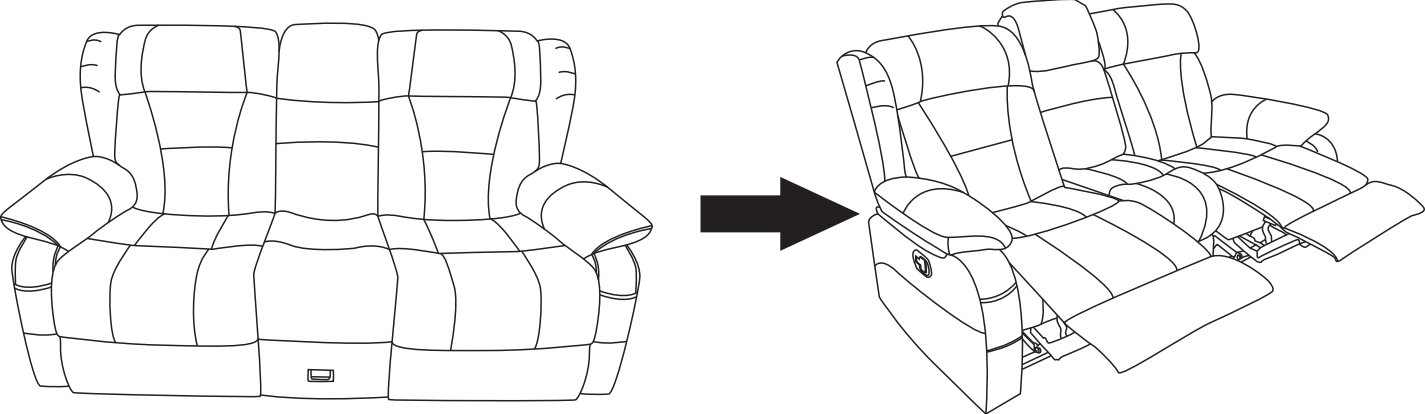

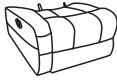

STEP 4

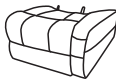

STEP 5

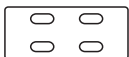

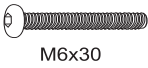
Assembly Instruction

BOX-A			
NO.	DRAWING	QTY	DESCRIPTION
A1		1	LSF SEAT
C1		1	LSF ARM
D1		1	LSF EAR
BOX-B			
A2		1	RSF SEAT
C2		1	RIGHT ARM
D2		1	RIGHT EAR
BOX-C			
B		2	BACK REST
H		2	CONNECTOR
I		8	NUT
J		4	PLASTIC PAD
K	 M6x30	8	SCREW
L		1	ALLEN KEY

STEP 1

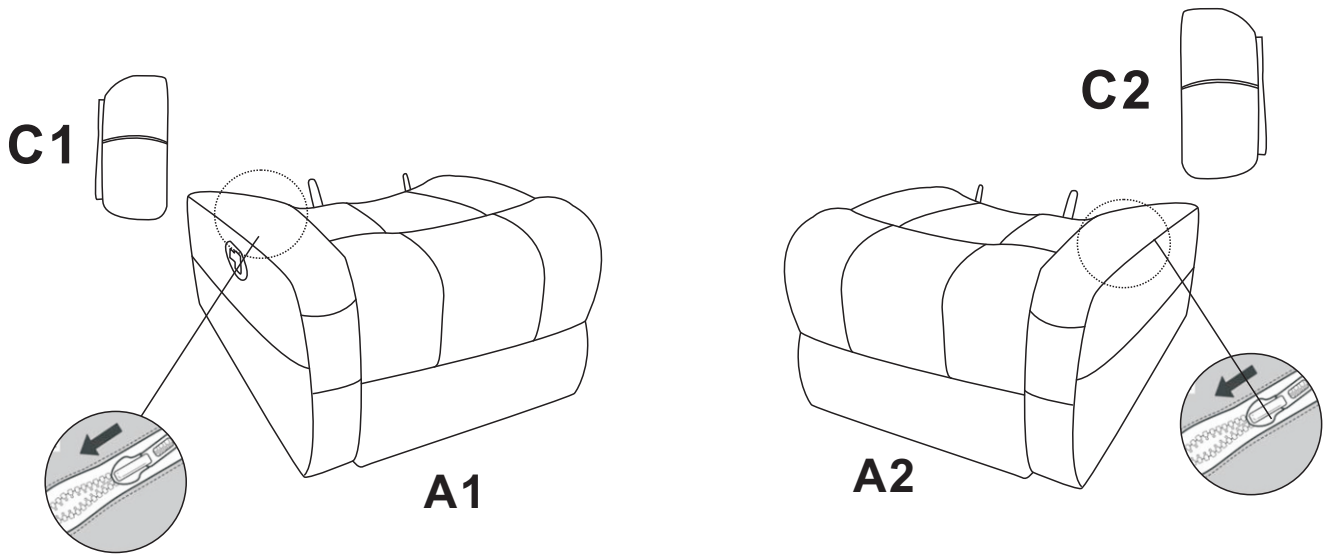

STEP 2

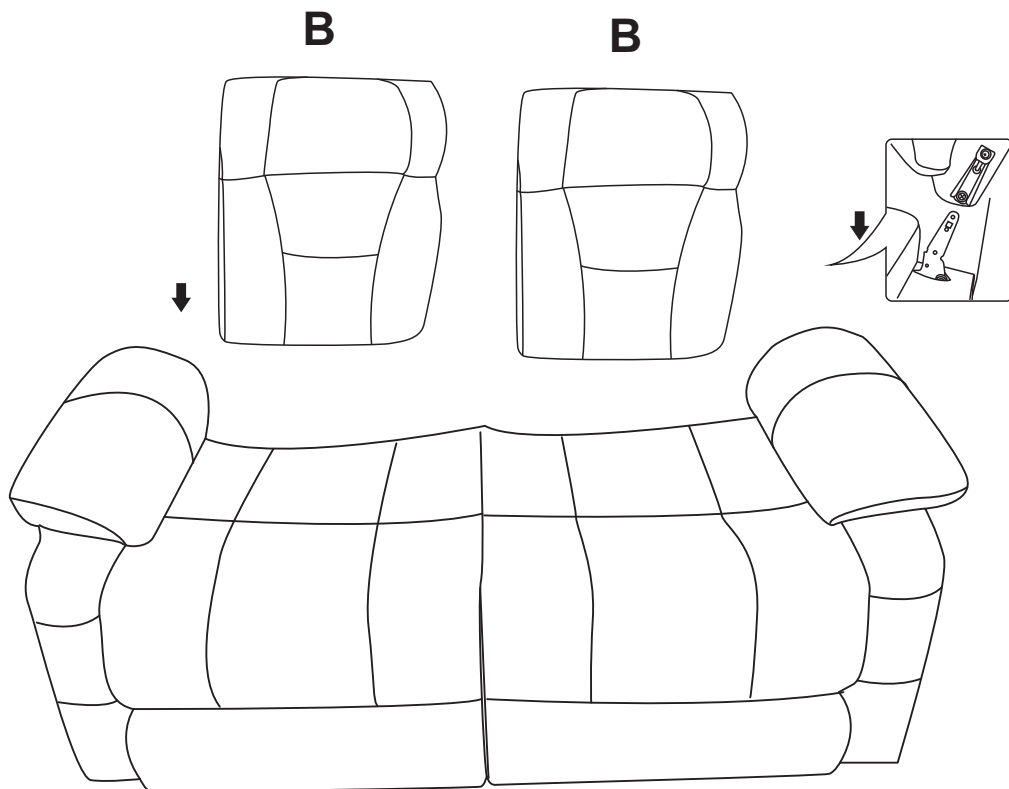

STEP 3

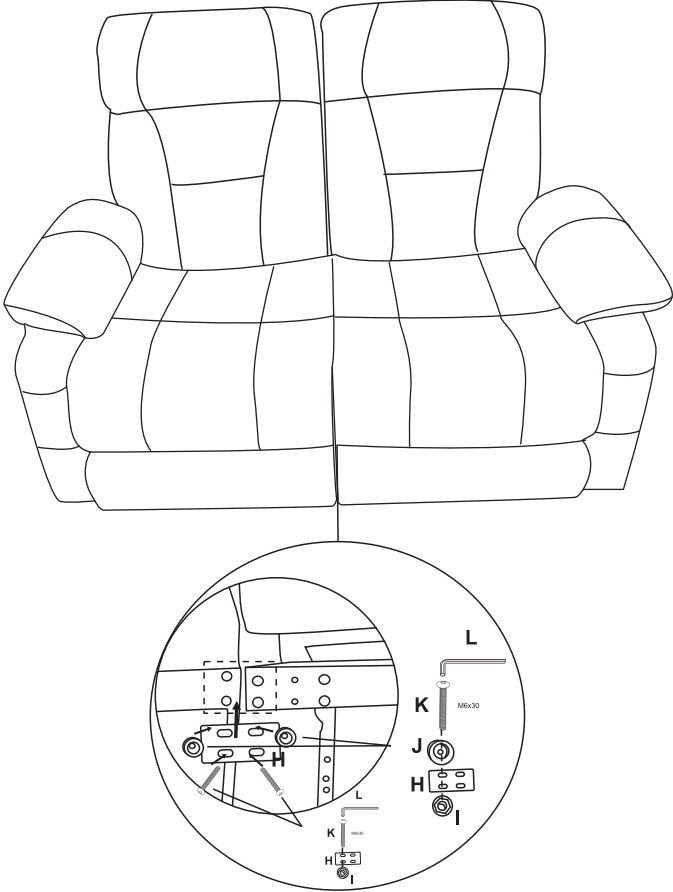

STEP 4

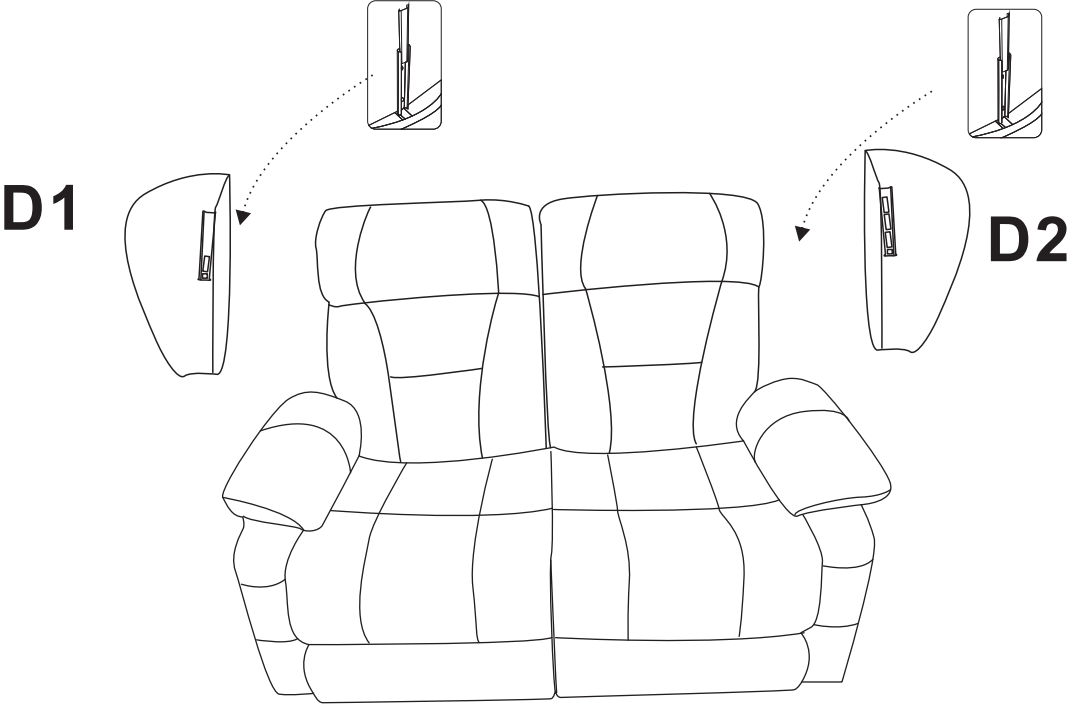

STEP 5

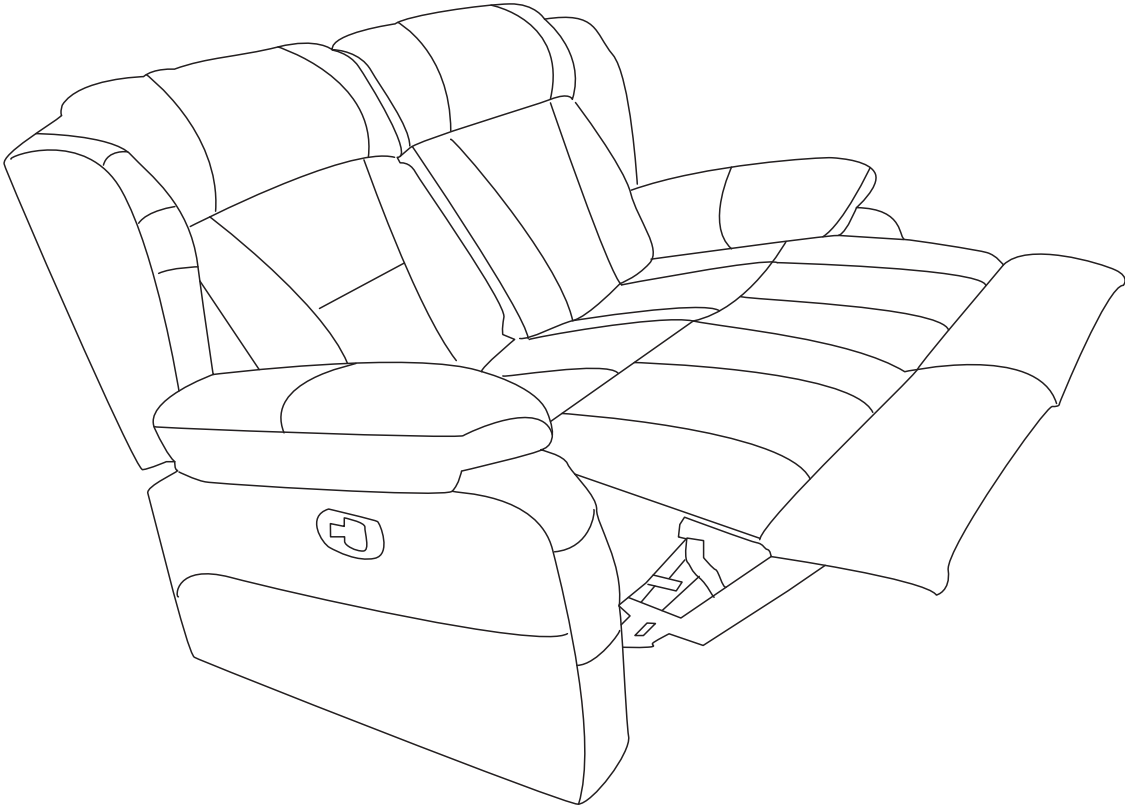
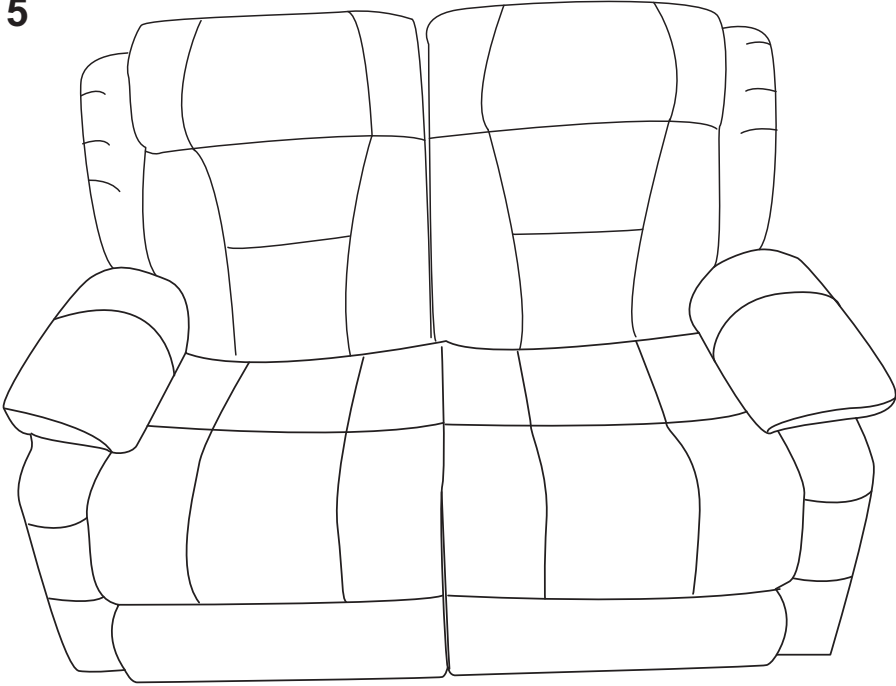

Warning

Do not sit/kick/stand on the footrest after lift up

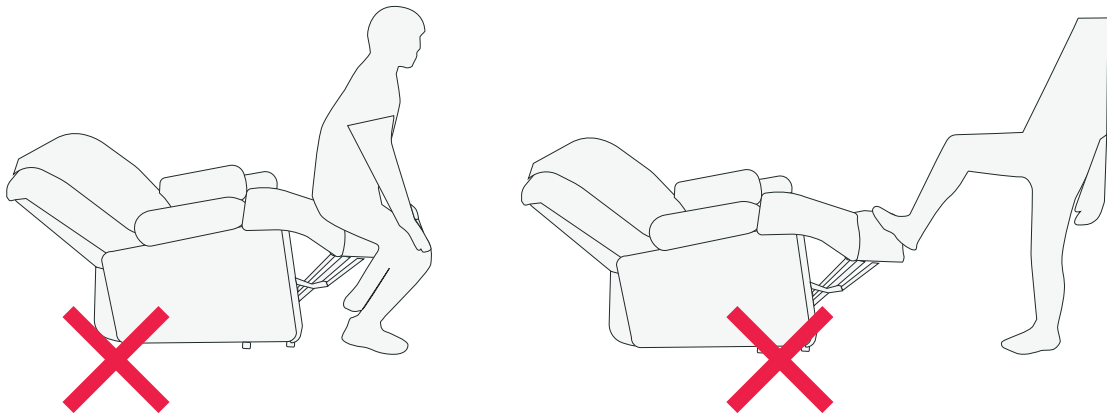
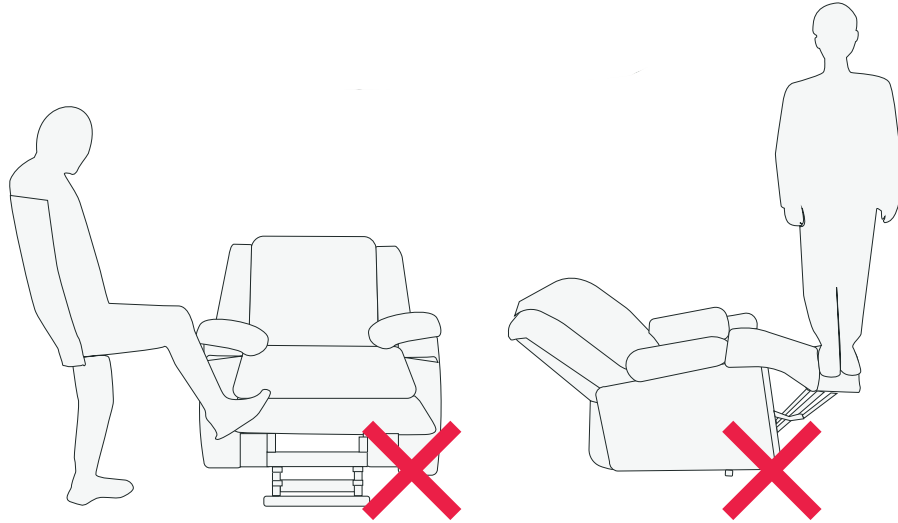

Leave enough space between chair back and wall before reclining

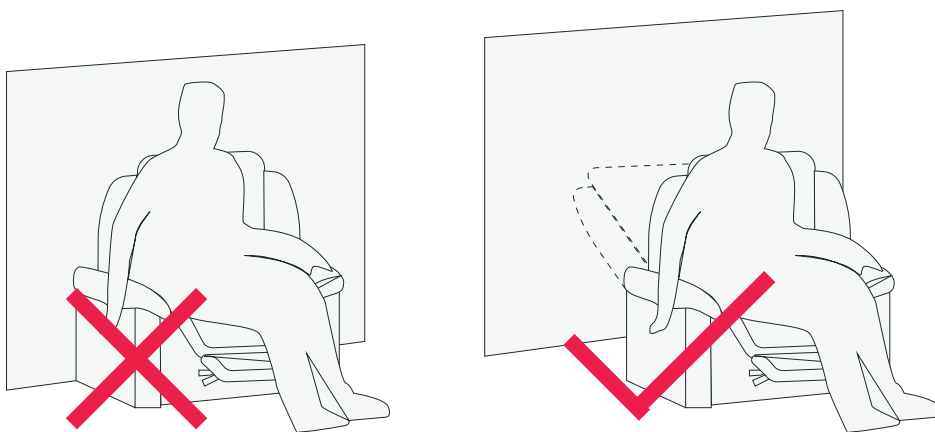

Warning

Leave enough space between chair back and wall before recline

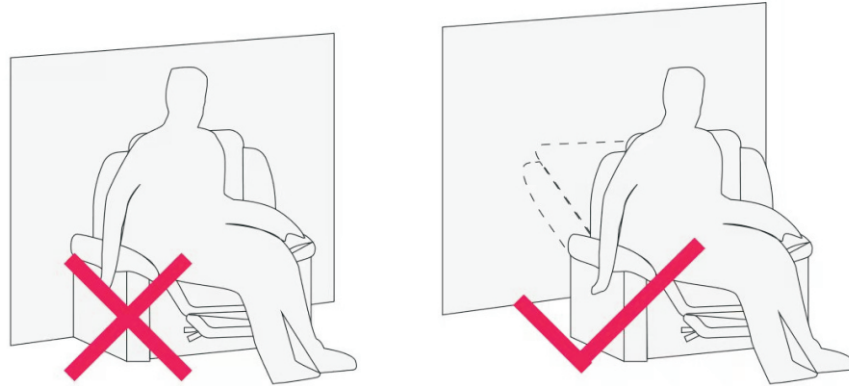

2-Person lift

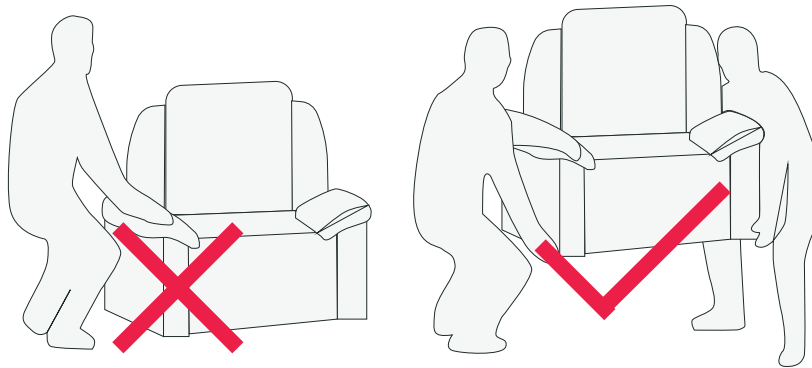

Do not move chair when it's reclining

