

# ASSEMBLY INSTRUCTIONS

## BATHROOM VANITY TOP

support@trendytotesinc.com

626 679 3588



PRODUCT  
INSTRUCTION  
VIDEO

# MODEL NBT-HG2422

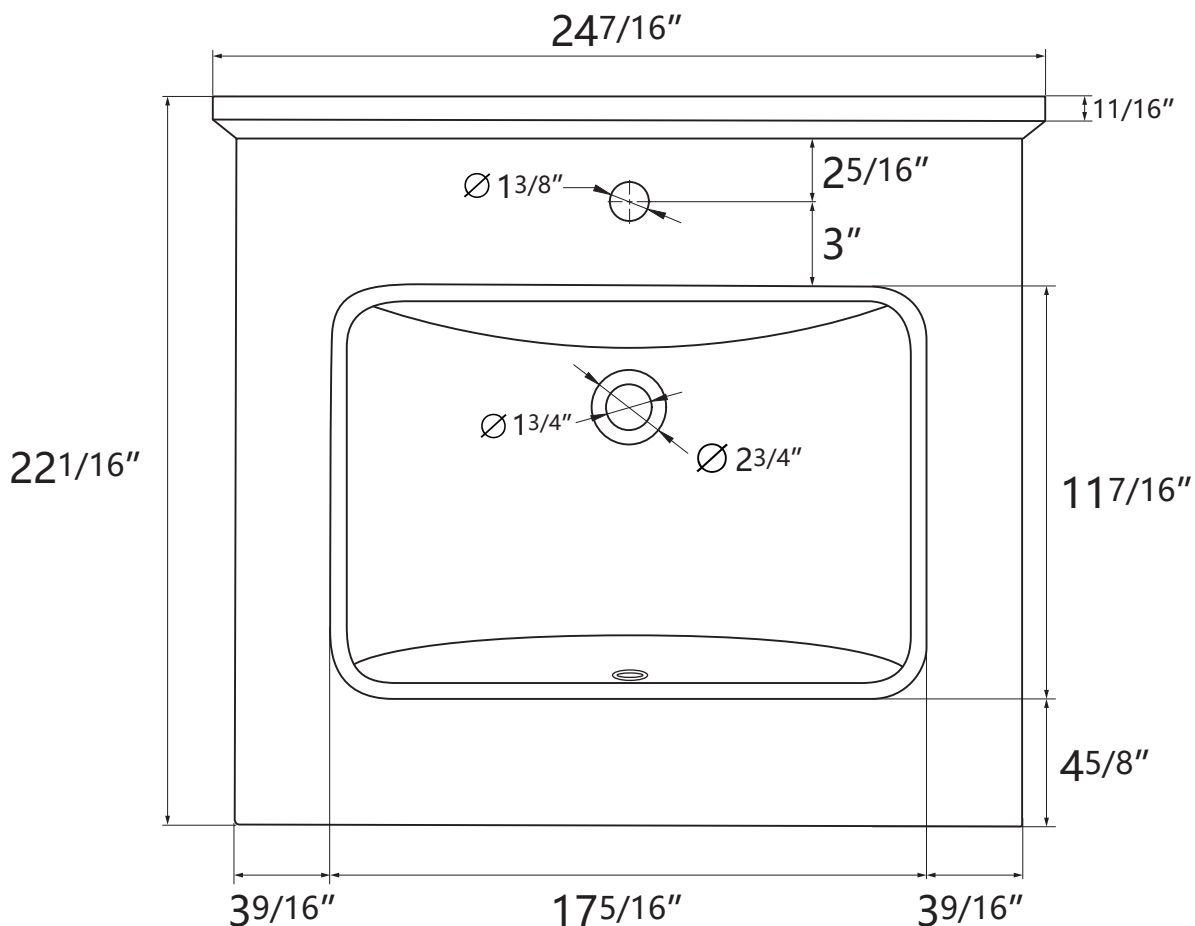



**NOTE:** Any size of the vanity's installation steps are the same.

## INSTALLATION STEPS

**1. Prepare the Vanity:** Make sure the vanity is in place and securely attached to the wall.

**2. Seal the Edges:** To prevent water damage and ensure a clean finish, apply a bead of silicone caulk along the edges where the countertop meets the vanity.

(For Example)



**3. Attach the Countertop:** Secure the solid surface countertop on the vanity.





# HOME SERVICES

---



INSTALLATION VIDEO

**Missing Part or Defective?**

Please Contact the Customer Service Team

 [support@trendytotesinc.com](mailto:support@trendytotesinc.com)