

Instruction manual

Armchair, Whitewash & Light Beige Boucle

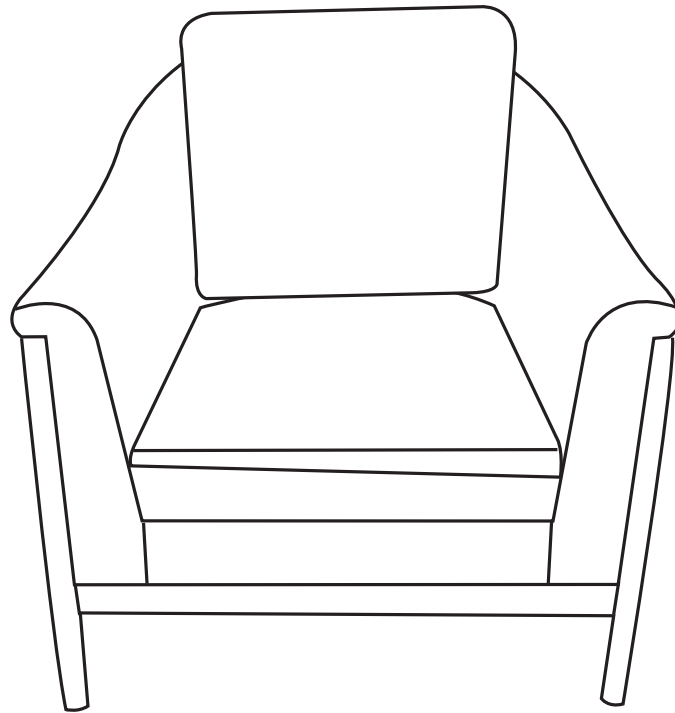

CONTENTS

Safety and care advice	1
Components	2
Assembly	4
Copyright	9

⚠ SAFETY AND CARE ADVICE ⚠

PLEASE READ THESE INSTRUCTIONS CAREFULLY AND KEEP FOR FUTURE REFERENCE

- **Warning:** Please lift with care.
- Check you have all the components and tools listed on pages 2 and 3.
- Remove all fittings from the plastic bags and separate them into their groups.
- Keep children and animals away from the work area, small parts could choke if swallowed.
- Make sure you have enough space to lay out the parts before starting.
- Do not stand or put weight on the product, this could cause damage.
- Assemble the item as close to its final position (in the same room) as possible.

- Assemble on a soft level surface to avoid damaging the unit or your floor (use opened out unit carton).



- We do not recommend the use of power drill/drivers **for inserting screws**, as this could damage the unit. Only use hand screwdrivers.
- Dispose of all packaging carefully and responsibly.

CARE AND MAINTENANCE

- Only clean using a damp cloth and mild detergent, do not use bleach or abrasive cleaners.
- From time to time check that there are no loose screws on this unit.

- This product should not be discarded with household waste. Take to your local authority waste disposal center.

Note *If required the next page can be cut out and used as reference throughout the assembly. Keep this page with these instructions for future reference.*

COMPONENTS

Ensure the following components are in the box before proceeding with assembly:

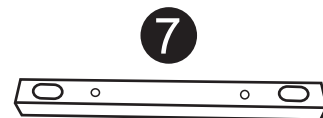
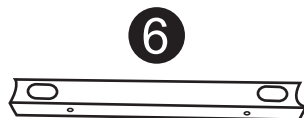
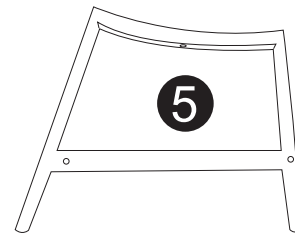
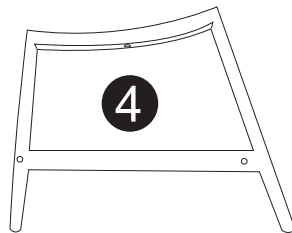
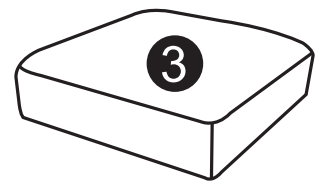
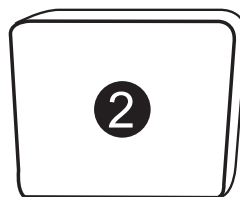
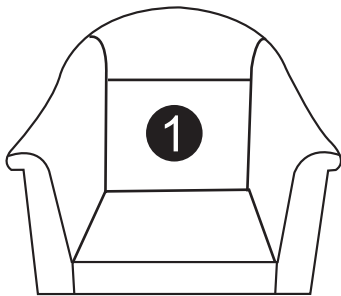

PANEL LIST

1	Seat	x1	6	front cross	x1
2	back cushion	x1	7	back cross	x1
3	seat cushion	x1			
4	left arm	x1			
5	right arm	x1			



COMPONENTS — FITTINGS

Ensure the following components are in the box before proceeding with assembly:

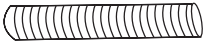
Ax4 
M6*70mm

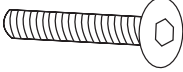
Bx2 
M6*60mm

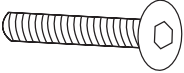
Cx4 
M6*45mm

Dx4 

Ex4 

Fx4 

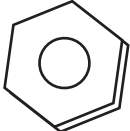
Gx4 

Hx1 

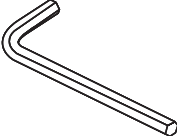
Ix1 



ASSEMBLY INSTRUCTIONS

Step 1

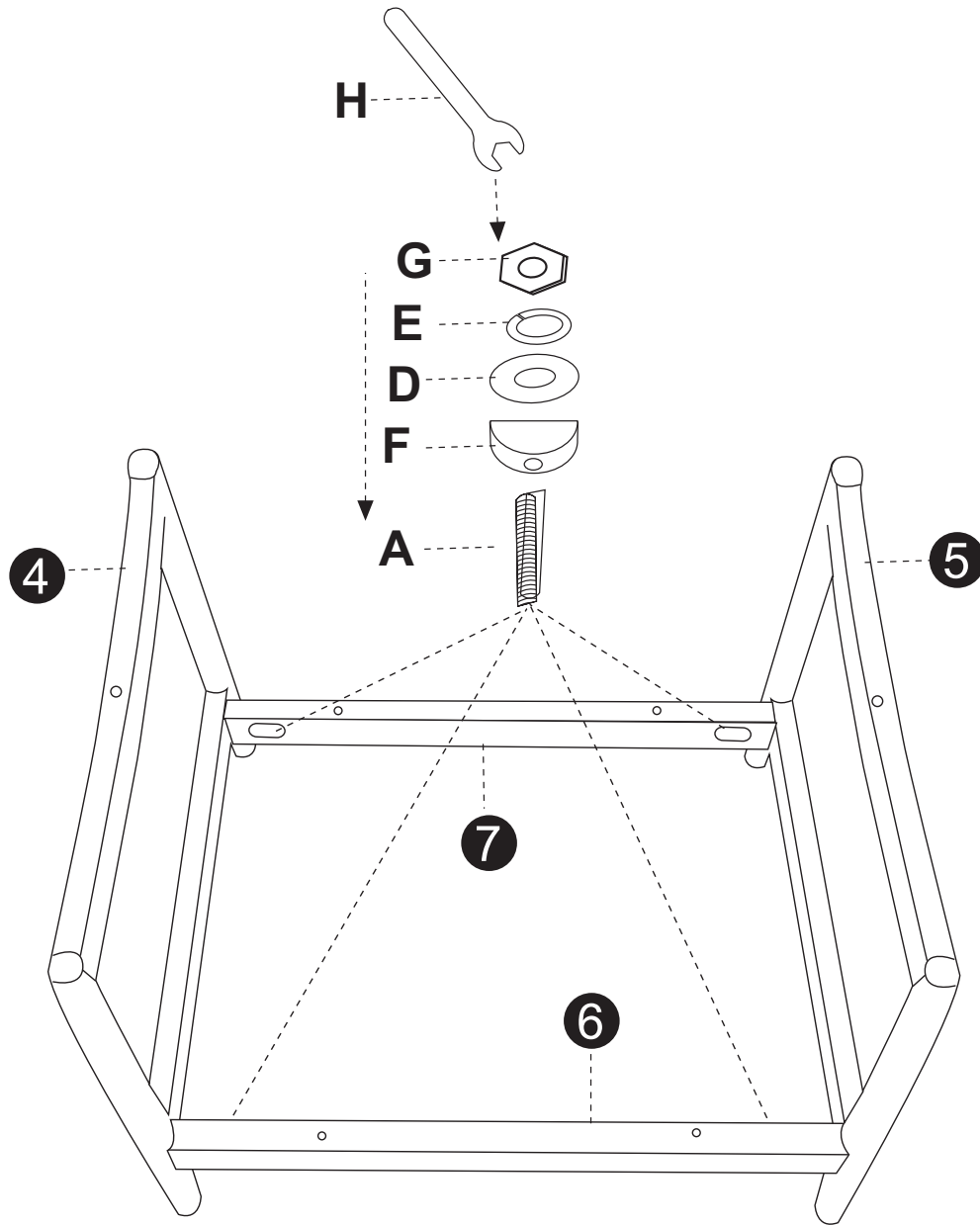

ASSEMBLY INSTRUCTIONS

Step 3

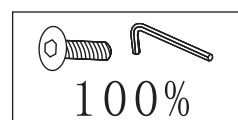
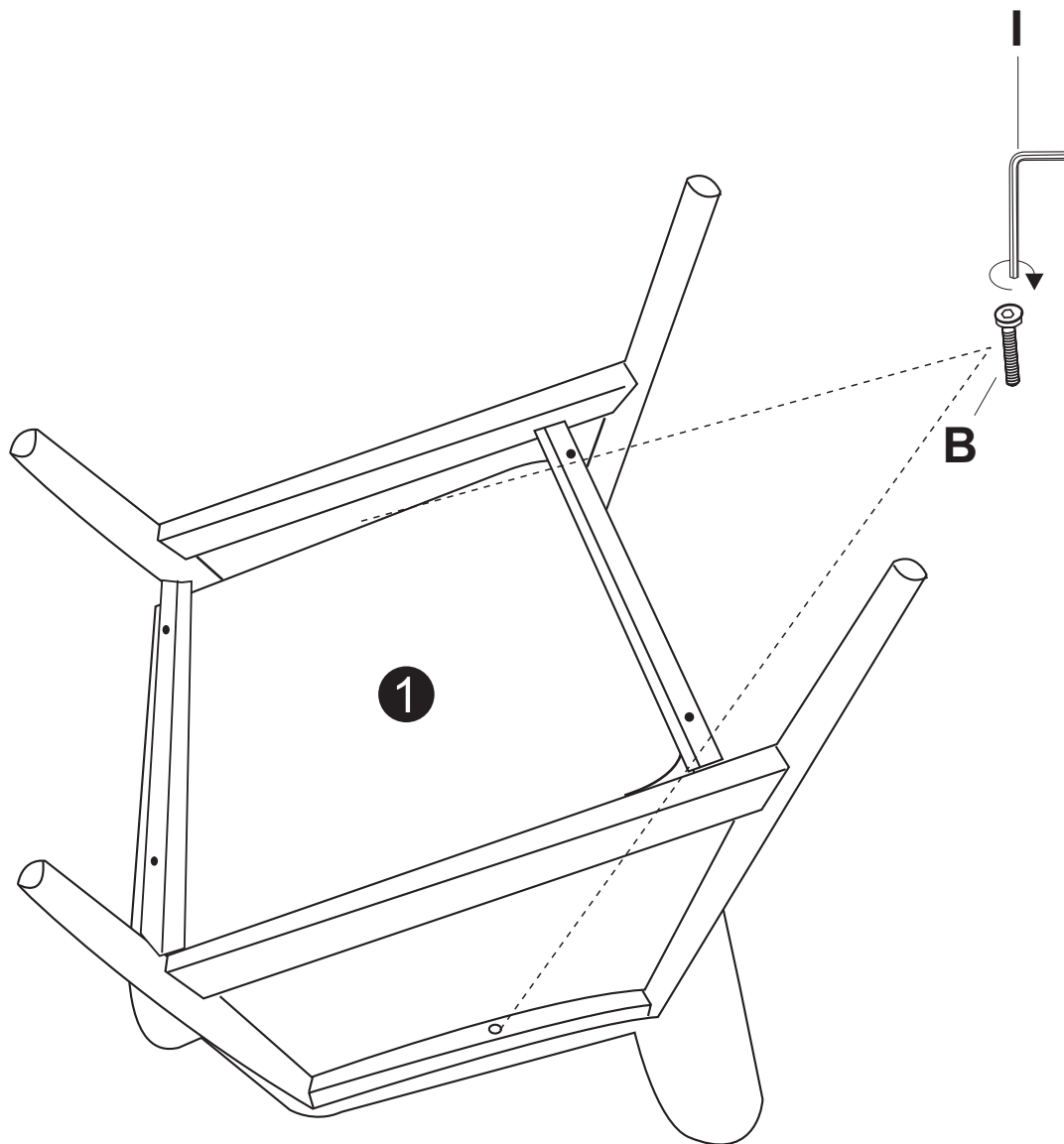

ASSEMBLY INSTRUCTIONS

Step 4

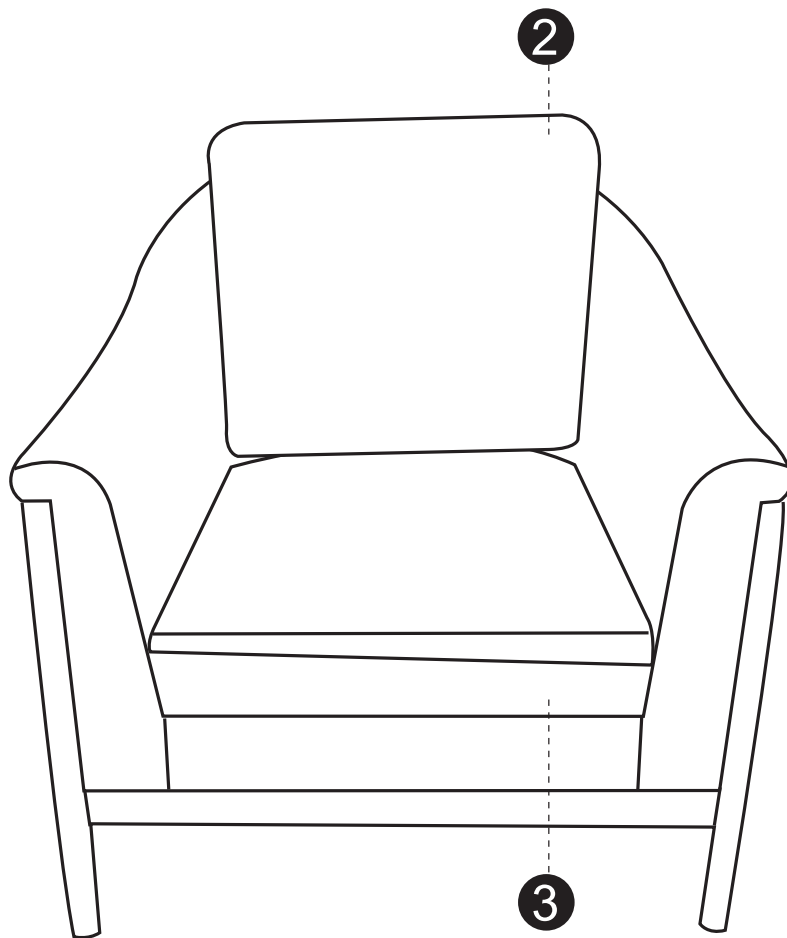

IF YOU FIND A DEFECTIVE PART

We fully stock all parts and components. Any defective part can be quickly replaced. Take note of the defective part number in manual and we will arrange a replacement.

COPYRIGHT

All material in this instruction manual is copyrighted.

Any unauthorised use may violate worldwide copyright, trademark and other laws.