

INSTALLATION MANUAL

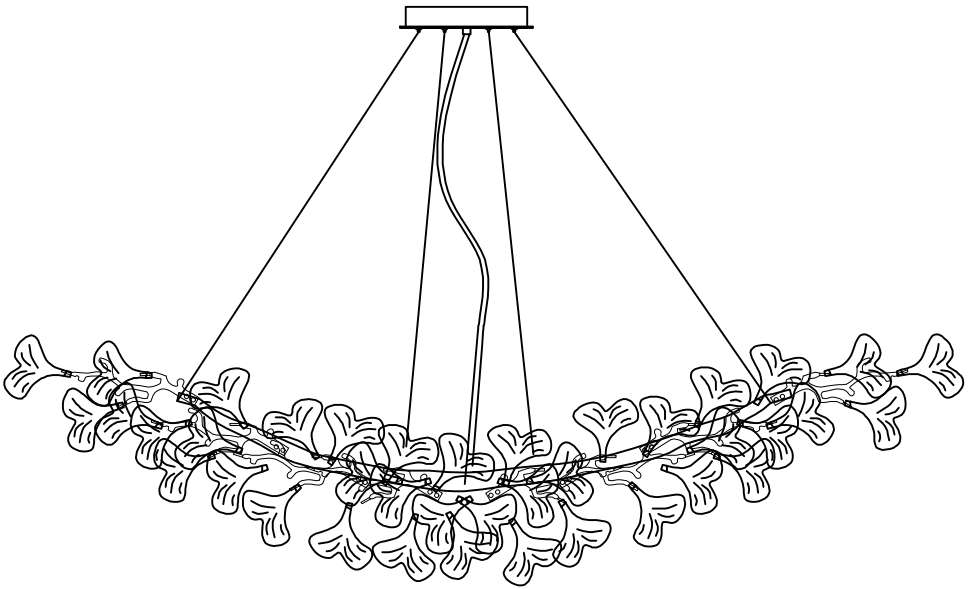

accessories list

Ax2

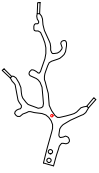

Bx20

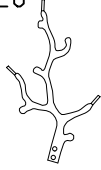

Cx44

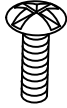

Dx3



Ex2



Fx1

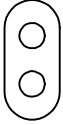

Gx66



Hx66



Ix1



Jx2



Kx4



Lx4

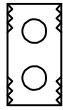

Mx1



Nx1



STEP I Unpacking

Open the box, and take out all the accessories, you will get the following items.

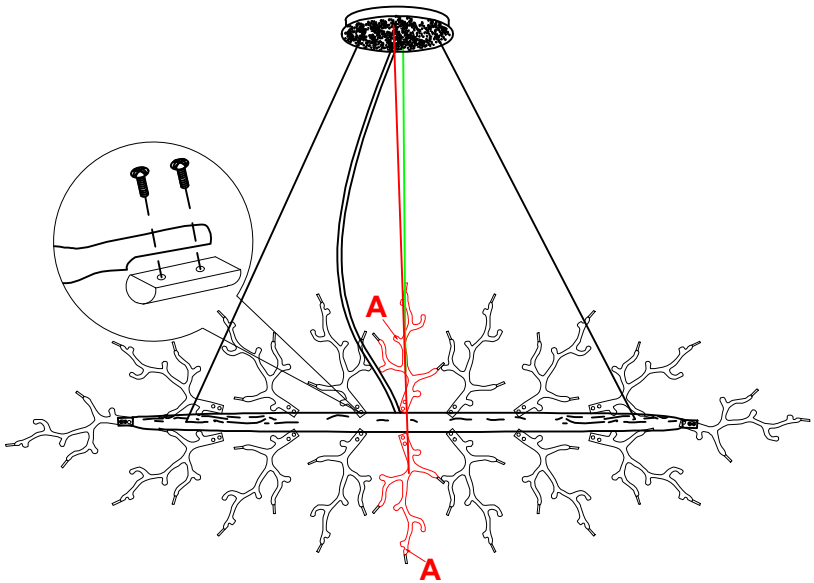

FAQ

Q:When I opened the box,I found some hanging parts were broken.

A:The hanging parts are inherently fragile,and we have considered this situation.
We have prepared spare hanging parts in each box,which is enough for your installation.

STEP II Branch Adjustment

Unfold the branches and distribute them evenly.

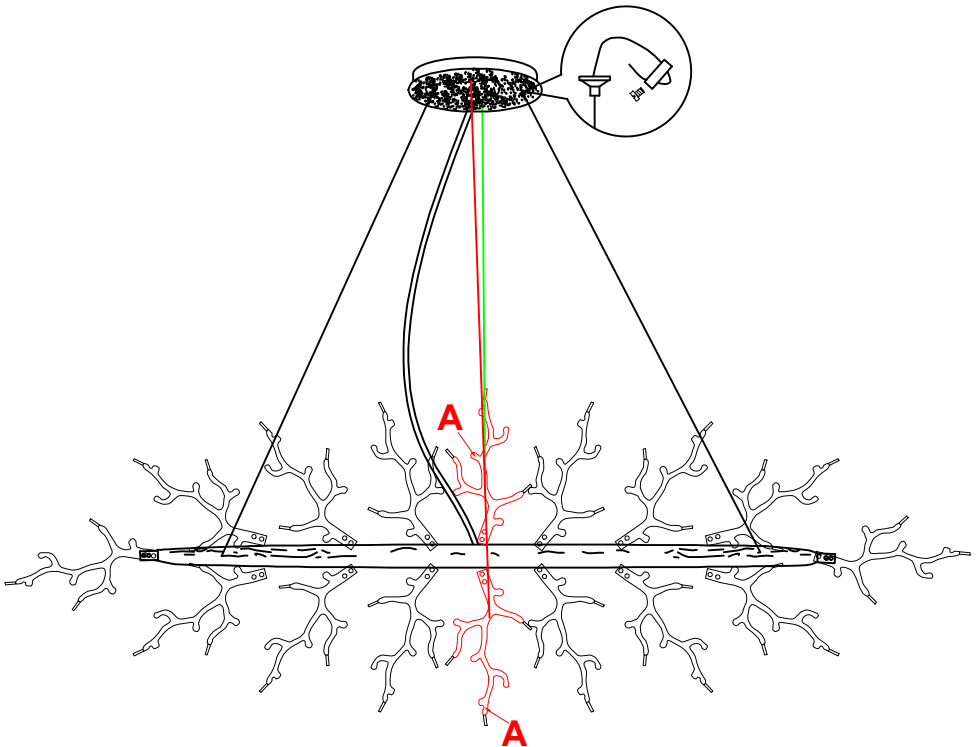

FAQ

Q:Is there a specific standard for branch adjustment.

A:There is no rule on what shape you must adjust,just keep the branches evenly distributed.Use your artistic talent to obtain a unique shape that belongs to you

STEP III Wiring and Mounting

1. Adjust the length of hanging cable and wire according to your requirement.
2. Take off the mounting bracket from ceiling canopy, and install it on ceiling.
3. Connect lamp wires and your house wires together.
4. Install the lamp frame on ceiling.

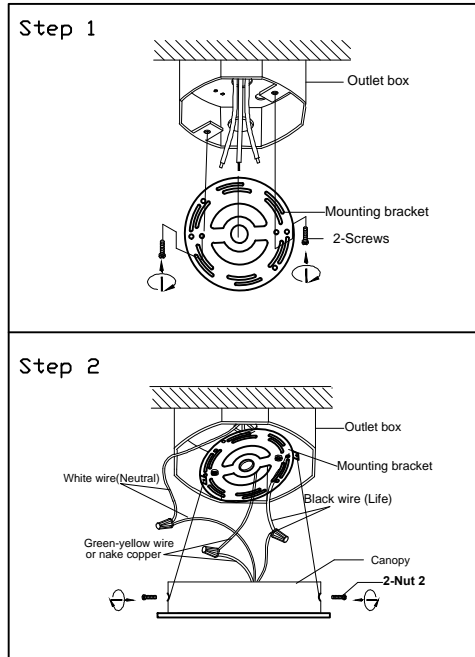

FAQ

Q:How to distinguish N/L wires and which one is the ground wire.

A:Wires do not need to distinguish between N/L wires,The brass wire on Mounting bracket is the ground wire.

STEP IV Hanging Pendants

Hang the pendants evenly on the branches with holes.

Then you could fine-tune the branches for best effect.

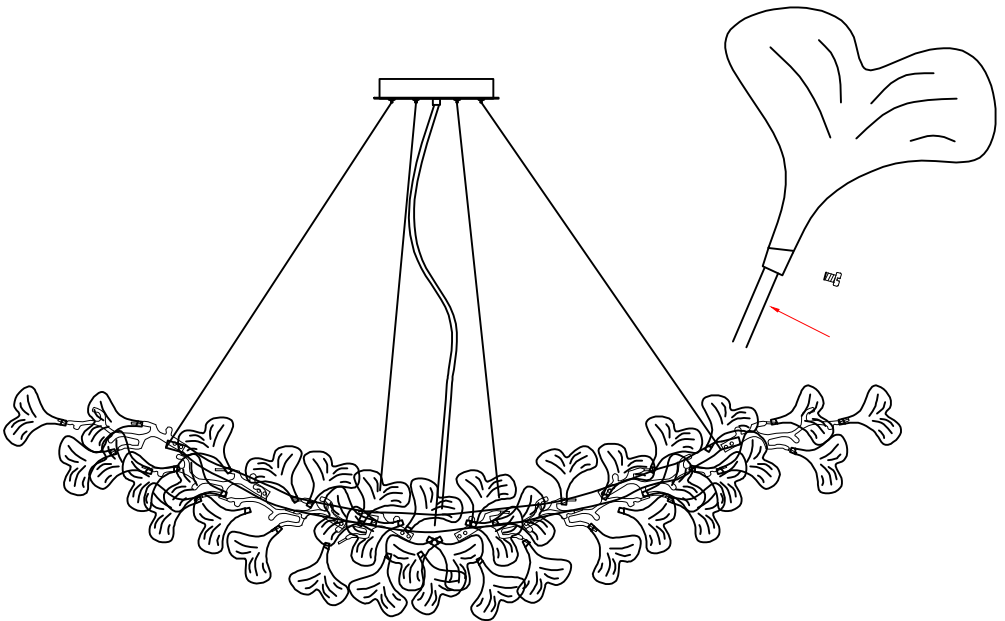

FAQ

Q:Do I have to hang pendants on all the branches.

A:Only the branches with holes need be hang with pendants.

It's not necessary to hang all the branches full of pendants, everyone's judgment on the sparsity of pendants is different, What you see is just right.

No matter what problems or questions you encounter during the installation or use of the chandelier, please feel free to contact us, we will reply to you within 24 hours and quickly solve or answer for you!

When you leave a message to us online, please leave your order ID and case details. The more detailed and accurate descriptions you provide, the faster and more accurate solutions we will offer!



SAFETY INSTRUCTIONS

These instructions are provided for your safety. It is very important that you read the instructions completely before starting the installation of your fixture.

1. We recommend installation by a licensed electrician.
2. This fixture require G9 bulbs(NOT INCLUDED) and bulb rated wattage: Max 10W.Low wattage LED bulbs are recommended. To avoid risk of fire, do not exceed the recommended wattage.
3. If any special control devices are used with this fixture, follow the instructions carefully to assure full compliance with N.E.C. requirements. If there are any problems, contact a qualified electrical contractor.
4. Please ensure that you shut off the main electrical supply before installation, changing bulbs or cleaning light fixture.



WARNINGS

THIS IS NOT A TOY AND THE PRODUCT HAS NO PLAY VALUE.
Keep at least 3 ft away from cribs, bassinets, and toddler beds.
Keep out of reach of children under 3 years old.



PREPARATION

1. Please prepare your purchased G9 bulbs in advance.
- 2.Please keep the installation place clean and tidy to avoid missing tiny accessories.