



# Web Spinner Net Swing

# 40"

## Assembly Instructions

### Package Contents:

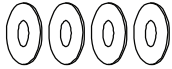
Make sure all parts are present and place them side by side for easy identification.

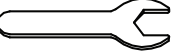
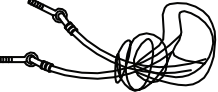
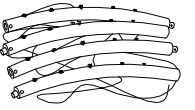
PART	NAME	QTY
A	Washer 	x4
B	Hex Nut 	x4
C	Hex Wrench 	x1
D	Rope 	x2
E	Support Tubes, & Net Seat 	x1

### Before Assembly:

1. Take the swing out of the box and check the material. If the material is not in good status, stop using immediately.
2. Confirm that the supporting structure is secure. Fix the swing on two strains of a tree, swing set, or other strong fixing point or frame.

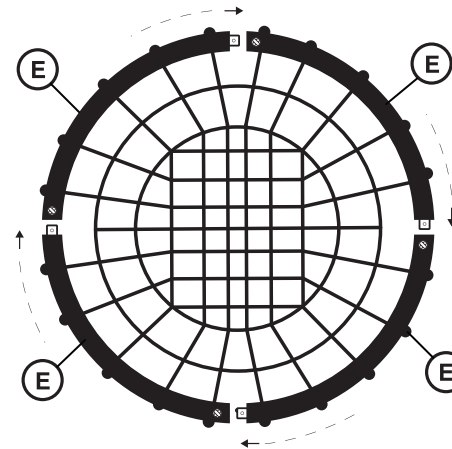

#### STEP 1

Lay down all 4 sections of the Support Tubes & Rope (E) like the illustration shown above.

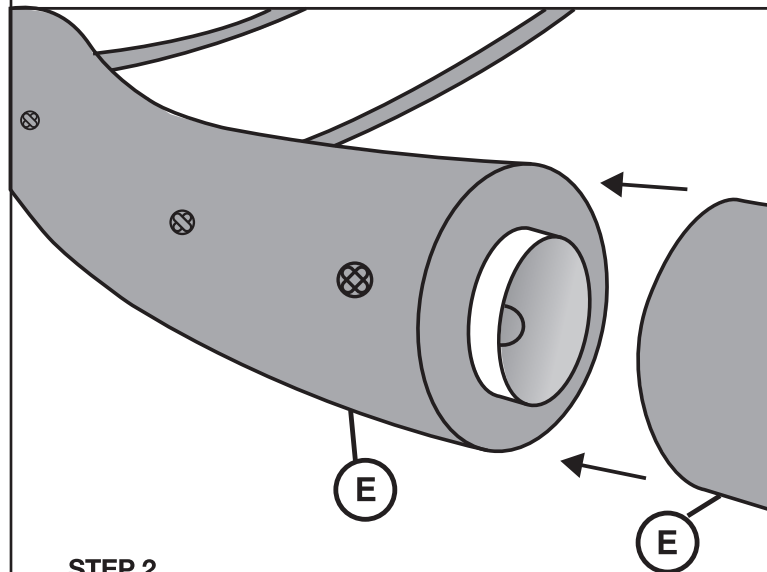

#### STEP 2

Begin connecting each of the 4 Support Tubes (E) like the illustration above.

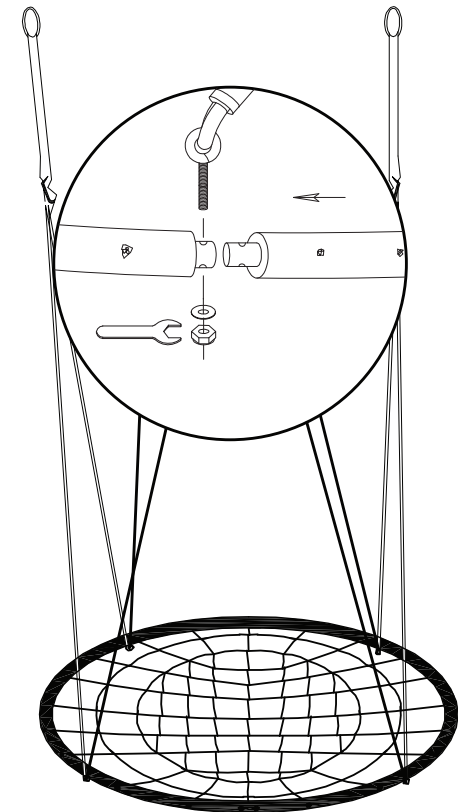

Product fully assembled.

#### STEP 3

After inserting the rope (E) accordingly, slide washer (A) into place and secure with hex nut (B) by using the provided hex wrench (C).

#### Liability:

Install at your own risk. While every attempt is made to embody the highest protection in all equipment, we can not guarantee freedom from injury. The user assumes all risk of injury due to use and all merchandise is sold on this condition. The manufacturers are not responsible for any injuries due to the use of this product.

Recommended for children 5 + years.