













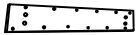

# Assembly Instruction

## Parts List:

REF	PART NAME	PART IMAGE	QTY	REF	PART NAME	PART IMAGE	QTY	
A	Foot tube		2	G	STEEL WASHER M6		38	+1PCS
B	Foot tube		2	H	STEEL WASHER M8		8	+1PCS
C	Desktop		6	I	SPRING GASKET M8		8	+1PCS
D	Desktop support		2	J	BOLT (M6*15)		8	+1PCS
E	Desktop support		1	K	BOLT (M6*30)		30	+1PCS
F	Foot connector pipe		1	L	BOLT (M8*20)		8	+1PCS
				M	WRENCH M6		2	
				N	WRENCH M8		1	



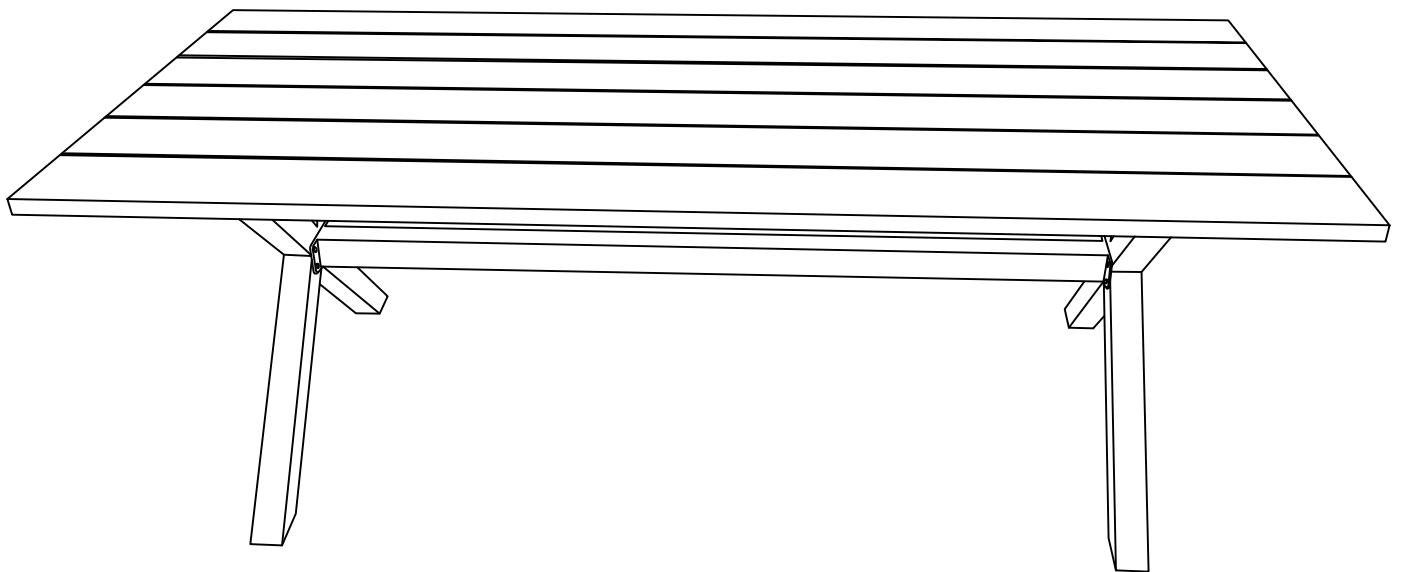
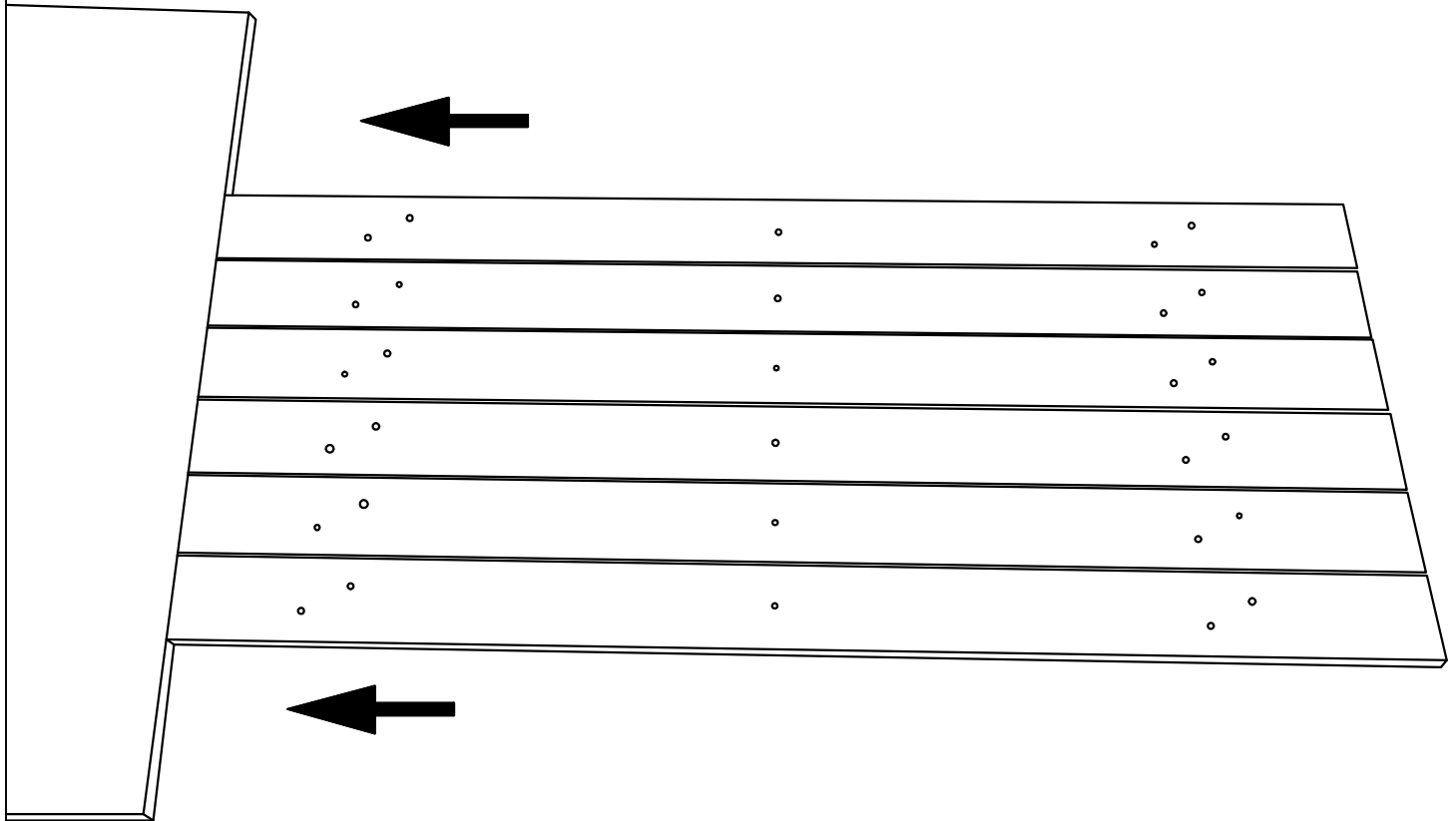

STEP 1

\*1

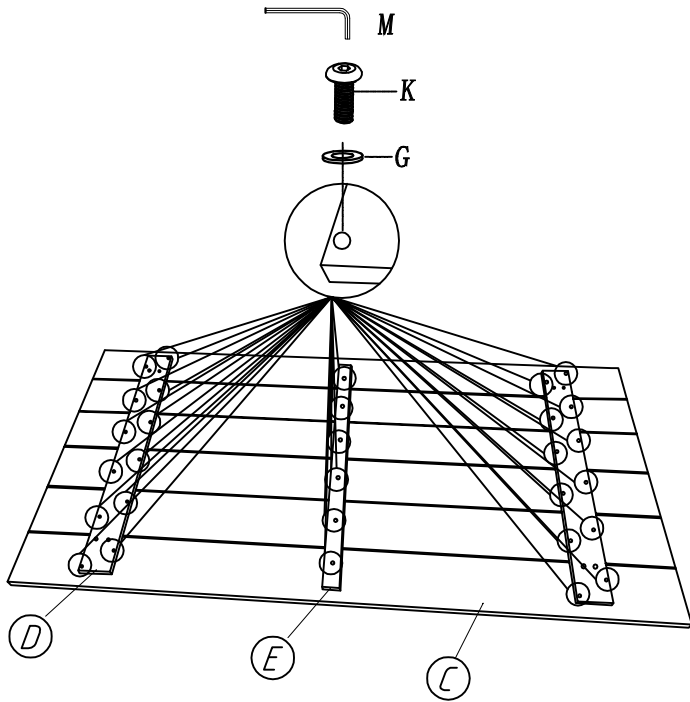

STEP 2

\*1

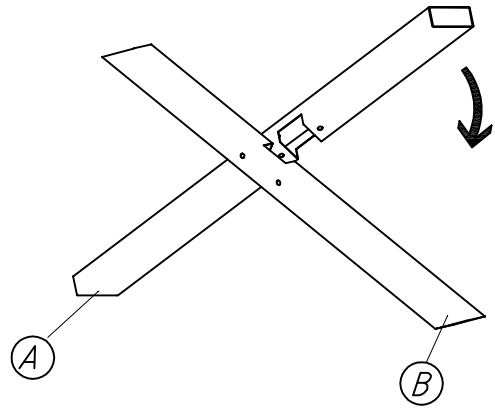

STEP 3

\*1

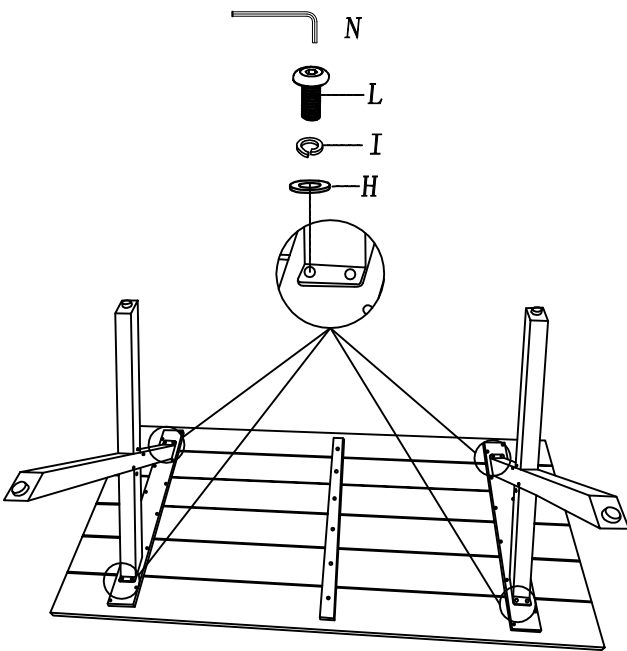

STEP 4

\*1

