



**MCombo®**

OWNER'S MANUAL  
**POWER  
RECLINER SOFA**

 shopify



Mcombo.com

 amazon



Amazon.com/mcombo

---

Newacme LLC, 2808 Vail Ave, Commerce, CA, 90040  
sales@mcombo.com  
1-323-597-1109

All rights reserved

---

**NEWACME LLC** [www.mcombo.com](http://www.mcombo.com) / [sales@mcombo.com](mailto:sales@mcombo.com)

**6160-RS6314**

Hello,

Thank you for choosing MCombo®

Let's get started

#### ○ PURCHASER'S AGREEMENT

By accepting delivery of this product, you promise that you will not change, alter, or modify this product or remove or render inoperable or unsafe any guards, shields or other safety features of this product.

You will not refuse or neglect any retrofit kits that MCombo may provide to enhance and preserve the safe use of this product.

# CONTENTS

<b>I</b>	<b>SAFETY GUIDELINES</b>	- 01	<b>VI</b>	<b>DISASSEMBLY INSTRUCTION</b>	- 16
	<ul style="list-style-type: none"> <li>• Mandatory</li> <li>• Danger</li> <li>• Warning</li> <li>• Symbols Information</li> <li>• Disclaimer</li> </ul>			<ul style="list-style-type: none"> <li>• Disassemble Backrests</li> <li>• Disassemble Armrests</li> </ul>	
<b>II</b>	<b>ASSEMBLY INSTRUCTIONS</b>	- 04	<b>VII</b>	<b>WARRANTY</b>	- 18
	<ul style="list-style-type: none"> <li>• Product Parameters</li> <li>• Part List</li> <li>• Assembly Steps</li> </ul>				
<b>III</b>	<b>OPERATING INSTRUCTIONS</b>	- 10	<b>VIII</b>	<b>RETURN/ REPLACEMENT- POLICY</b>	- 19
	<ul style="list-style-type: none"> <li>• Operation Precautions</li> <li>• Operation Instruction</li> </ul>				
<b>IV</b>	<b>CARE AND MAINTENANCE</b>	- 12	<b>IX</b>	<b>MCOMBO CUSTOMER SUPPORT</b>	- 20
	<ul style="list-style-type: none"> <li>• Fabric Care</li> <li>• Faux Leather Care</li> <li>• Electronics Care</li> <li>• Disposal &amp; Recycling</li> </ul>				
<b>V</b>	<b>TROUBLESHOOTING</b>	- 14			

# I. SAFETY GUIDELINES

## 1. Mandatory

Read the safety and other instructions thoroughly before using your MCombo® product. Failure to follow the guidelines, warnings in this manual and those located on your product can result in personal injury or product damage and will void the product warranty. Keep this manual for future reference.

## 2. Danger

- To prevent suffocation, keep plastic bags away from children.
- Do not allow children play on or near the product when in use. Serious injury or death could occur if a child is under the product when the product is in motion.
- Keep cord out of reach of small children, and do not use where it may be a trip hazard.
- Plug directly into a wall outlet. Do not use an extension cord or adapter.
- Do not use this product if it is wet, in water, around water or any liquid.
- Always leave in an upright and closed position. Keep hands and feet clear of mechanism and all moving parts. Footrest must be completely closed before getting in or out of the product. Only the occupant should operate the product.
- Before moving or troubleshooting, unplug power cords from outlet and secure the mechanism to prevent unexpected movement of the product.

## 3. Warning

- Weight Capacity: 320 lbs.
- Do not use outdoors. INDOOR USE ONLY.
- To avoid tip over, do not put your weight against the back of the product.
- Do not stand, sit, or place extra weight on the arms, back or open footrest.
- Do not use this product if it is damaged. Do not use attachments or substitute parts.
- Avoid exposing upholstered product to burning cigarettes or cigars, open flames, and high temperatures.

- Do not operate the unit until the back is installed and locked.
- Do not attempt to disassemble or repair the actuator or pump; no serviceable parts are inside.
- Do not allow electrical cord to be pinched between moving parts or between the frame and the floor. Do not place cord under carpet or in a location where it could become worn.
- Do not attempt to disconnect the power plug by pulling the power cord. Always hold the power plug and pull it out.
- Closely supervise children and disabled persons using this product.
- To reduce the risk of head entrapment and other injuries, keep children and pets away from openings and moving parts in and around furniture.
- This product has many moving parts, serious injury can occur if not used properly. Keep hands, fingers, and body parts away from the mechanism.
- To exit the unit safely and prevent a tripping hazard, bring the back upright and close the footrest.
- Place tables and area rugs at a distance to allow the footrest to fully extend without rubbing or interference.
- Check the condition of the power supplies, electrical cords, plugs, and connectors often. Keep the power supplies and electrical cords away from heat sources. Never operate the unit with a damaged power supply, electrical cord, plug or connector.
- Do not charge your device into the USB charge ports over 24hours.
- Do not charge any devices over 5V/2A with the USB charge ports.
- Do not overlay the USB charge ports with other heat-dissipating electronic products. This may prevent heat dissipation and cause overheating or melting.
- Unplug the power cord immediately if you detect strange odors or fumes coming from the chair. Contact your MCombo Customer Support.
- A seat is intended for a single occupant, not exceeding 320 pounds. Do not operate the seat with more than one occupant in or on any part of the product.
- If you give this product to someone else, must include this owner's manual.

## 4. Symbols Information

The symbols below represent labels used on the product to identify warnings, mandatory actions, and prohibited actions. It is especially important for you to read and understand these symbols completely. Do not remove these labels from your product. Please note that not all the symbols may be used on your product.



## 5. Disclaimer

Make sure you read and understand this manual completely before using your MCombo Product. We are not and cannot be held responsible for any damage or injury incurred due to improper or unsafe use of the MCombo Product. We specifically disclaim responsibility for any bodily injury or property damage that may occur during any use that does not comply with applicable federal, state, or local laws or ordinances.

## II. ASSEMBLY INSTRUCTIONS

### ■ Notice

- Please read these instruction thoroughly before using.
- Do not plug the power supply in until assembly complete.
- Please contact us (See "MCombo Customer Support" on Page) immediately if anything is missing or damaged.

## 1. Product Parameters

Specification	Description
Model No	6160-RS6314
Rated Voltage	100~240V
Rated Current	2A
Out put Voltage	29V
Reclining Angle	150°
Weight Capacity	320lbs
Package Quantity	3
USB power	7.5W

## 2. Part List

- **Notice**
- Use MCombo parts only for all replacements.

### Box 1 of 3

**A** Left Base x1

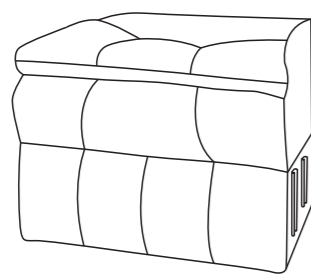

**B** Left Armrest x1

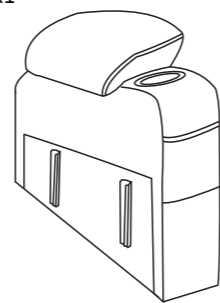

### Box 2 of 3

**C** Right Base x1

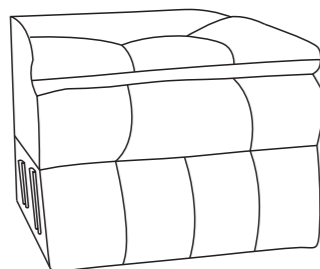

**D** Right Armrest x1

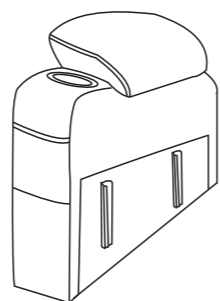

### Box 3 of 3

**E** Left Backrest x1

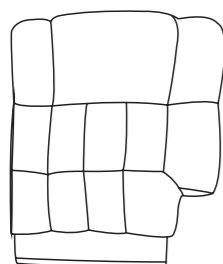

**F** Right Backrest x1

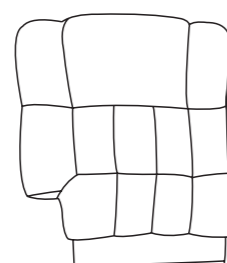

### Part Box

**1** Massage Remote x2

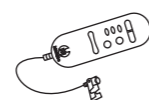

**2** Seat Iron Sheet x2

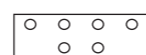

**3** Wrench x1



**4** Screw & Washer



**5** Power Adapter x2

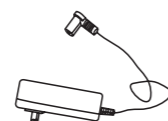

**6** Base Feet x4



## 3. Assembly Steps

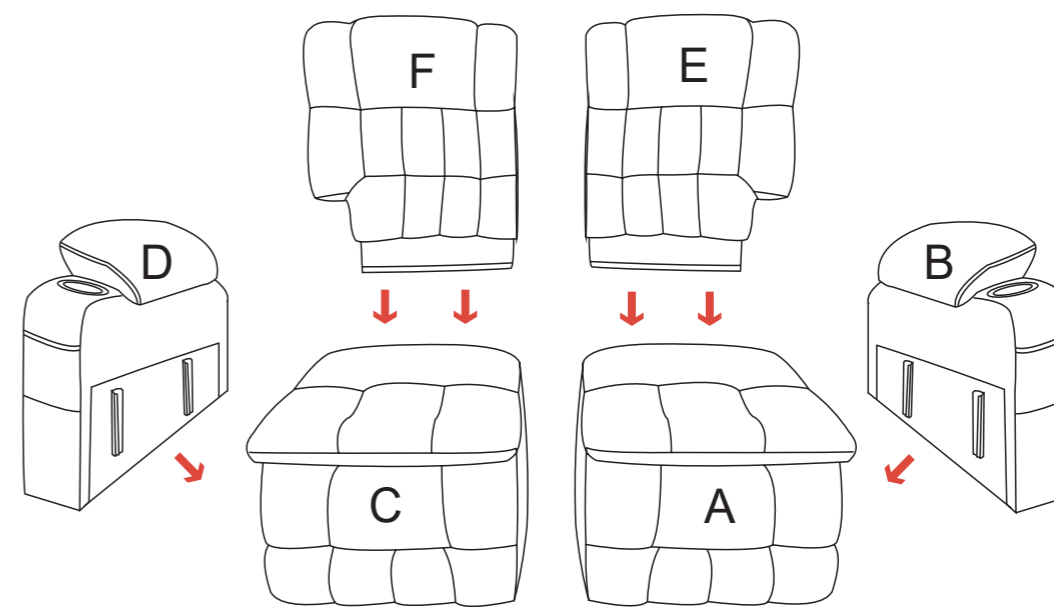

### Step1 - Bases Connection

1. Please use seat iron sheets (Part #②) to connect the seat bases (Part #A, and #C).
2. When installing the steel sheets (Part #②), please lightly tighten the screws (Part #④) first, no need to lock them, keep the steel sheets in a horizontal position, finally tighten all the screws (Part #④) when all steel sheets (Part #②) are installed and the gap between the seats is adjusted.

**Note:** Please connect the left base first.

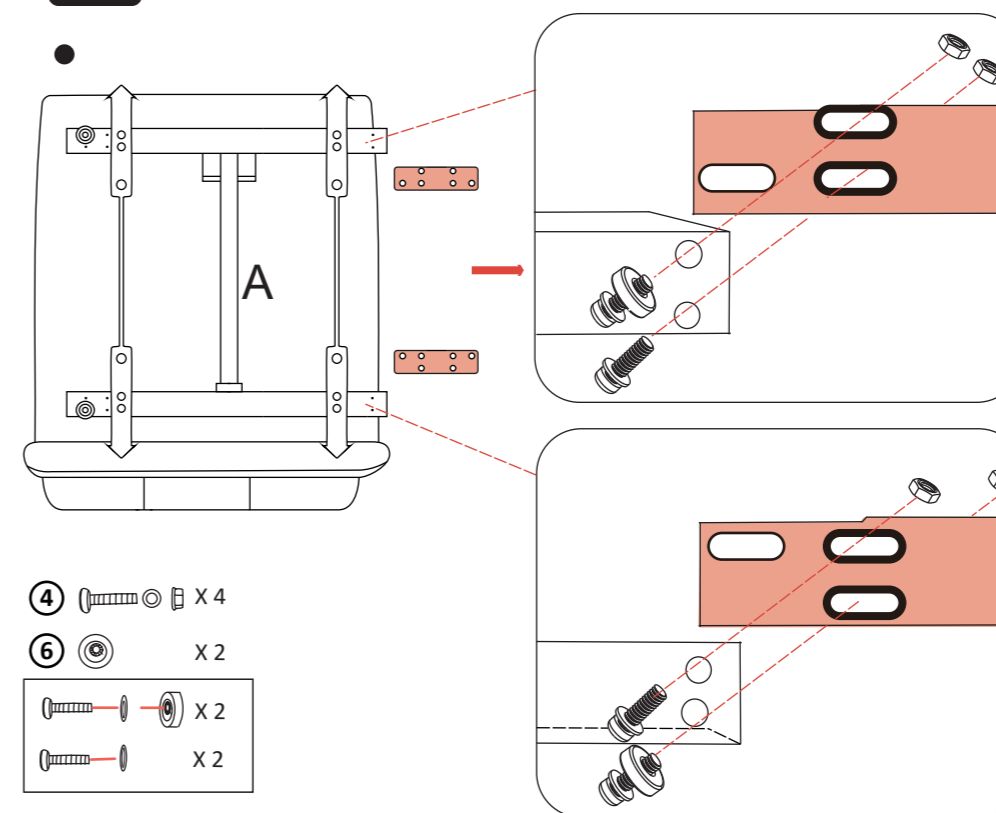

- ④ X 4
- ⑥ X 2
- X 2
- X 2

**ATTENTION**

The seat iron sheet needs to be installed on the iron frame, not under the iron frame.

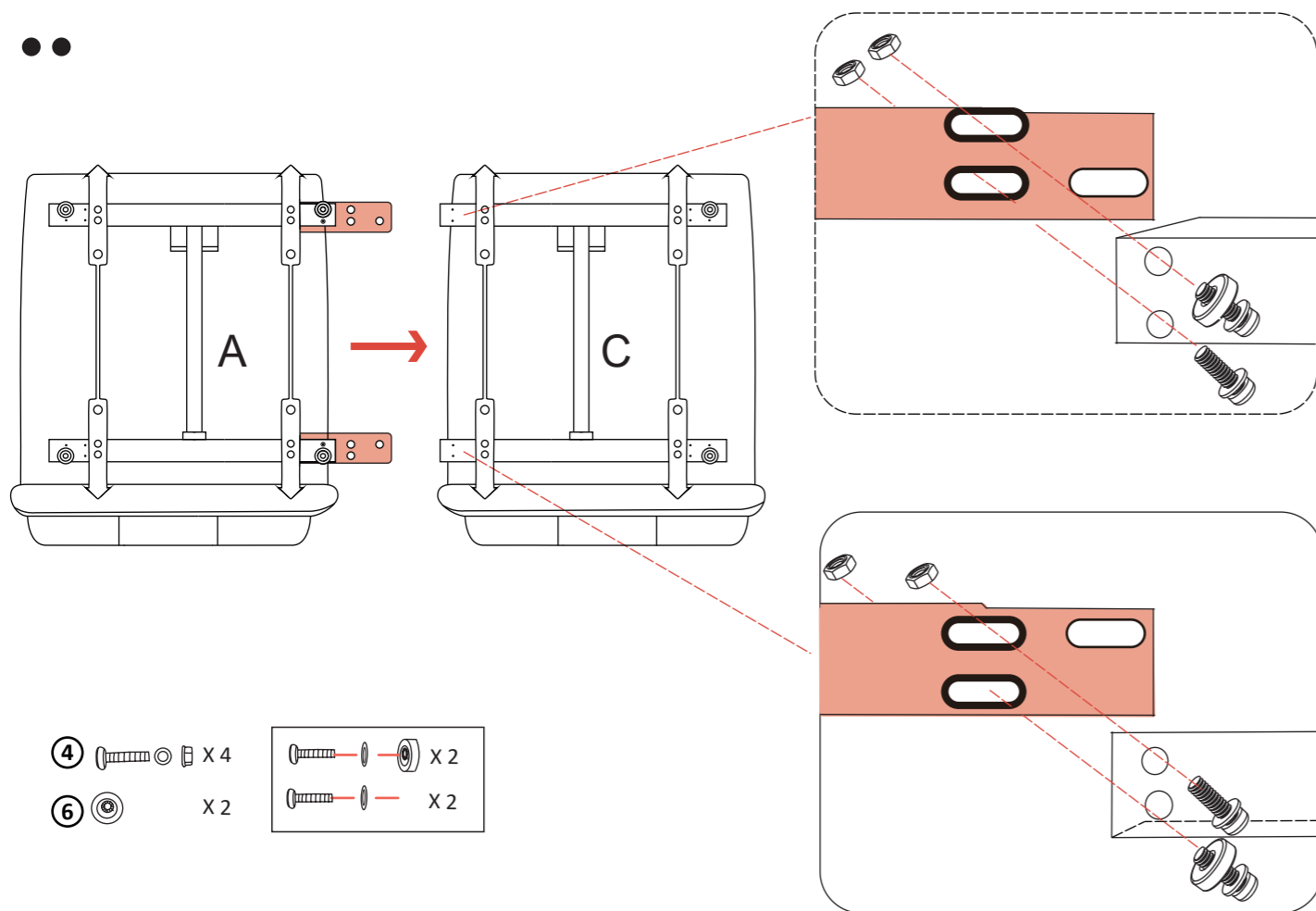

**Finished**

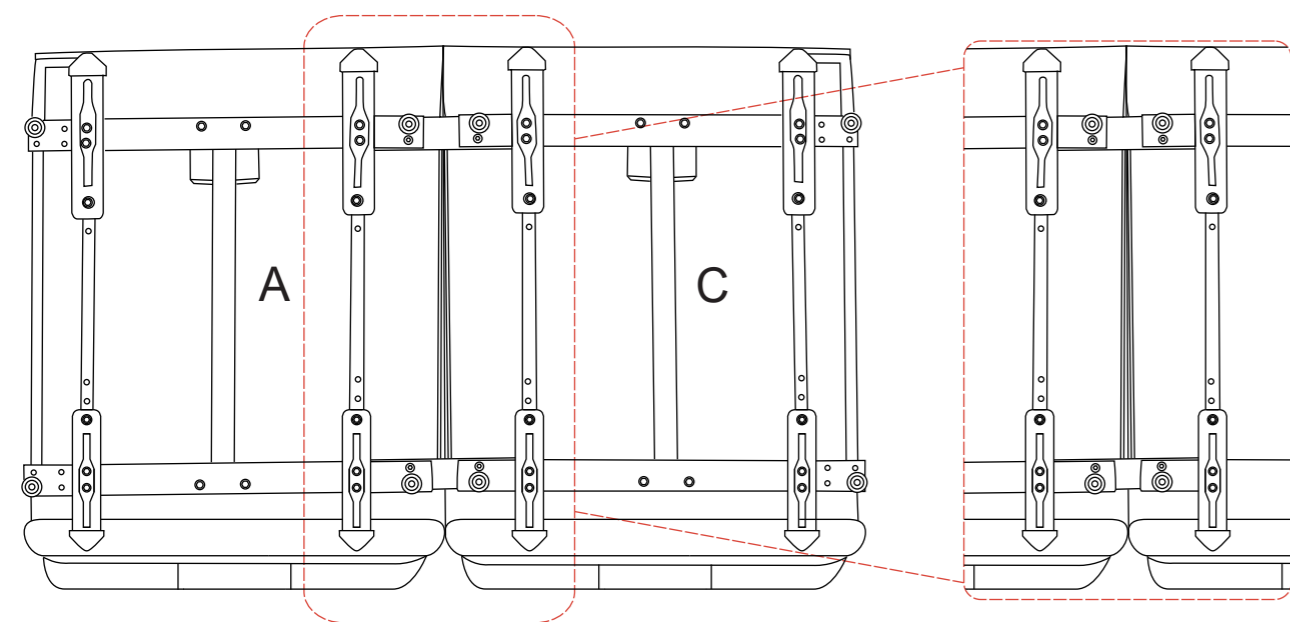

**Step2 - Armrests Assembly**

1. Align the brackets of armrest at the clips of the base (Figure).
2. Push firmly the brackets into the the base. Listen for a “click” on each side to ensure the armrest is locked in properly.

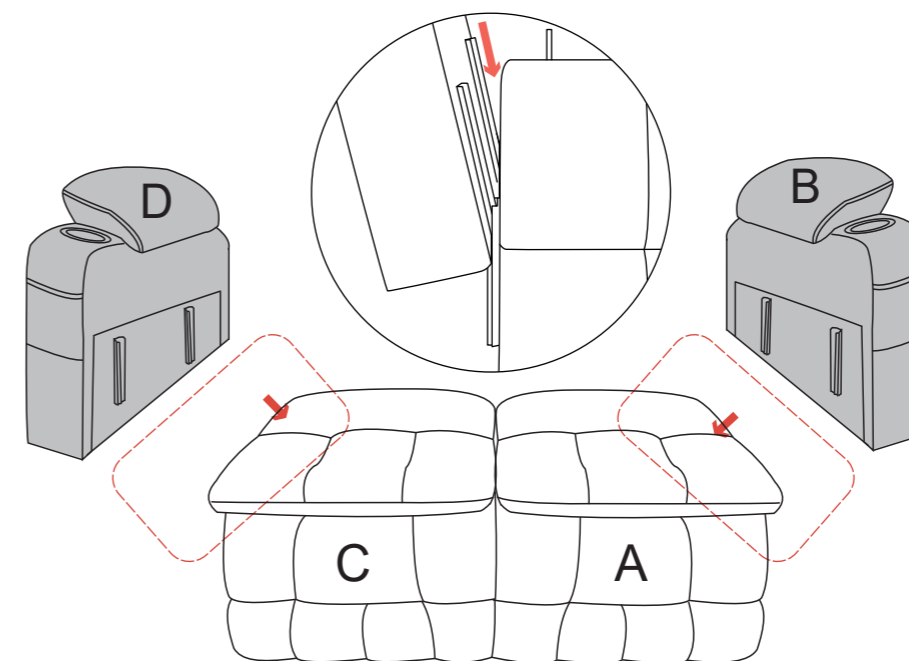

**ATTENTION**

Ensure the two connections on each armrest are all inserted onto the seat tightly.

**Step3 - Backrests Assembly**

1. Align the brackets of the backrest at the clips of seat-back (Figure).
2. Push firmly the brackets into the seat-back. Listen for a “click” on each side to ensure the backrest is locked in properly.

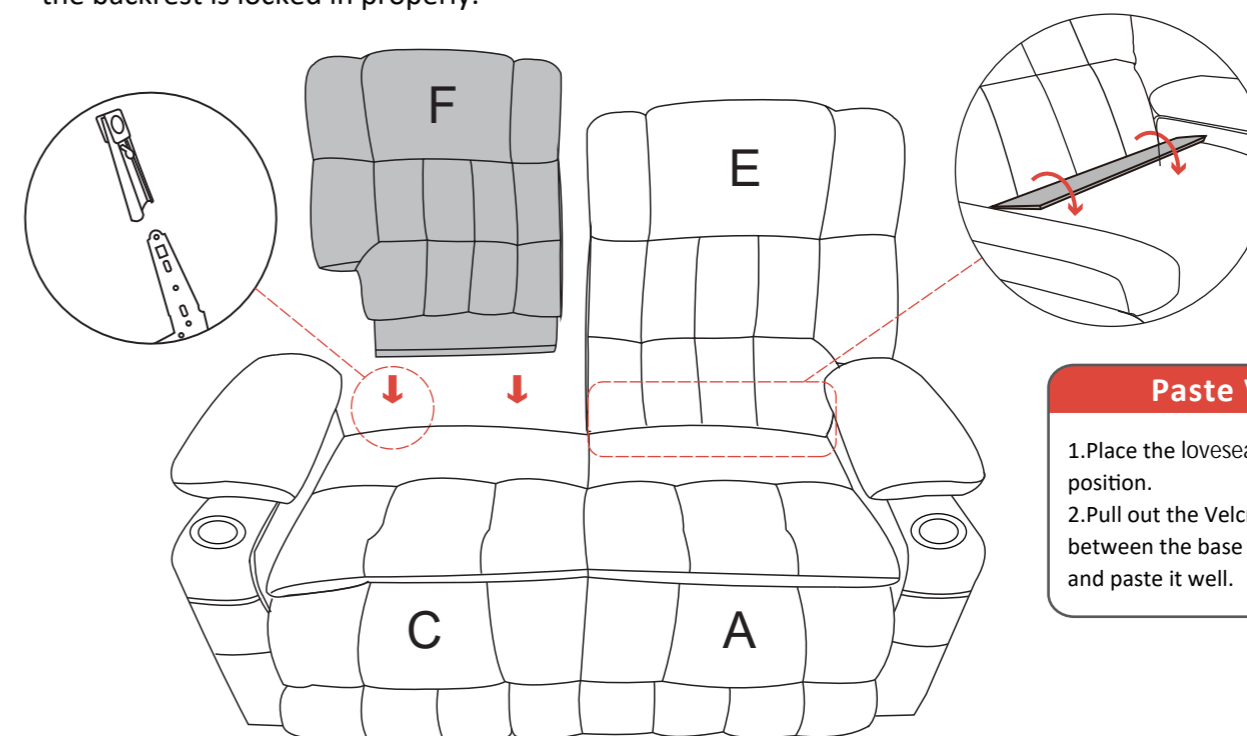

**Paste Velcro**

1. Place the loveseat in the reclined position.
2. Pull out the Velcro in the gap between the base and the backrest and paste it well.

### Step4 - Product Connections

1. No. (a) and No. (b) wires from the backrest and seat base with same color connect together.
2. No. (c) wire from the back connects to the massage remote.
3. The USB socket in the bottom of the recliner armrest.

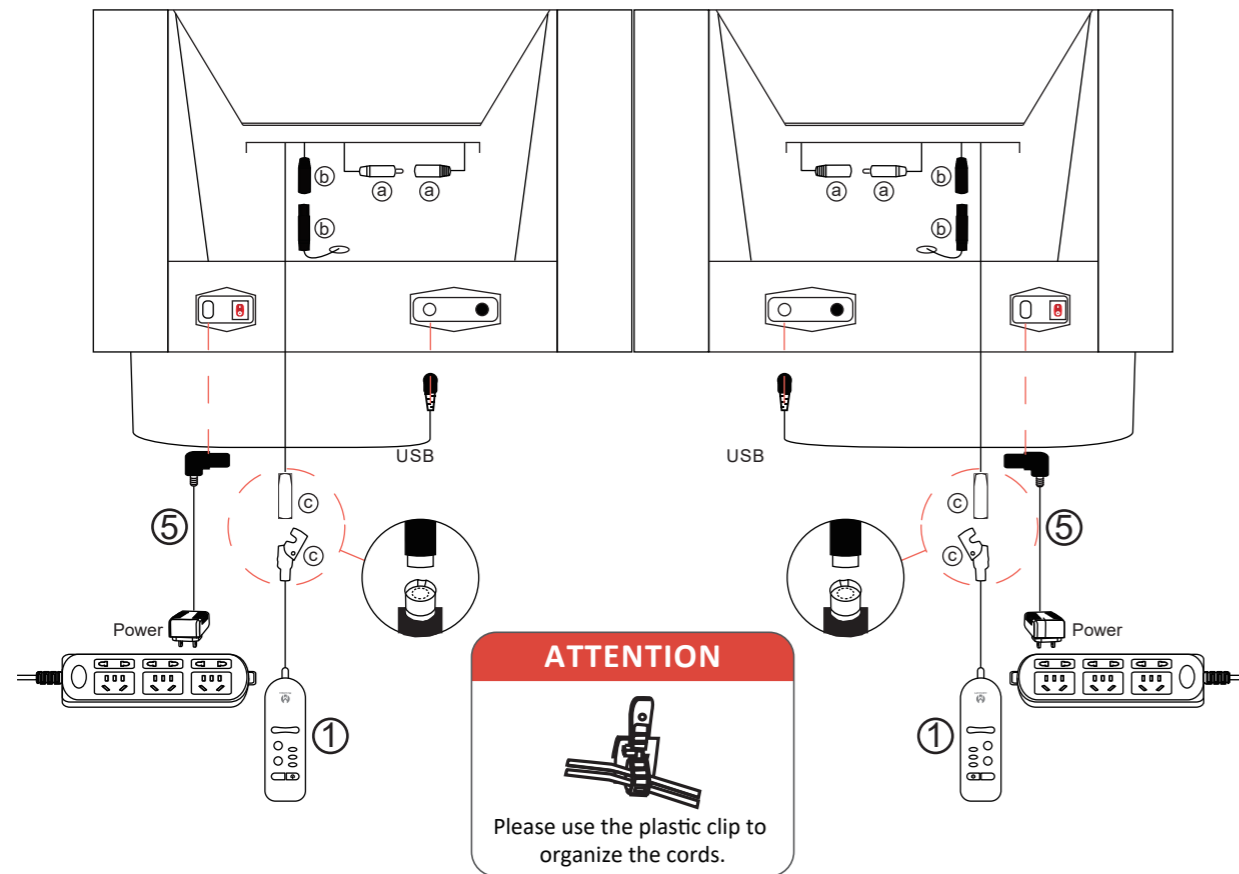

### Step5 - Final Check

1. Make sure both metal brackets on each armrest are mounted on the base.  
(There are two metal brackets on each side of the base, it looks like assembly is finished when you insert armrest into only one bracket instead of two, however all pressure will apply to one bracket, that is one likely reason that the armrest falls apart from the seat.)
2. Make sure the backrest inserts are locked to the base.  
(Pull up the backrest to check if it is locked in place.)
3. Make sure all wires are connected tightly.
4. Make sure all wires are not placed at the bottom of the rack and will not be pressed by frame.  
(If the wire is pressed by the frame, the wire will be broken by the frame and the sofa will stop working.)
5. Make sure all the screws are tightened.

## III. OPERATING INSTRUCTIONS

### 1. Operation Precautions

- Do not use an extension cord.
- Do not exceed recommended weight limit.
- Do not use attachments not recommended by the manufacturer.
- Do not use outdoors. INDOOR USE ONLY.
- Keep dry. Do not operate in a wet or moist environment.
- Keep all cords away from heated surfaces and pinch points.
- Always leave the product in an upright and closed position when not in use.
- Periodically check the control and all power cords for visible damage.
- Do not use the footrest as a seat, or for purposes outside its intended use.
- Do not lean or apply downward force to the seat-back while in recline position.

**NOTE:**

If you discover a problem at any point during the setup and positioning of your power recliner sofa, stop and contact the MCombo Customer Support immediately. To avoid personal injury or product damage, do not plug the unit into the electrical outlet until the problem is corrected and do not attempt to fix electrical problems by yourself.

### 2. Operation Instruction

● Control Buttons

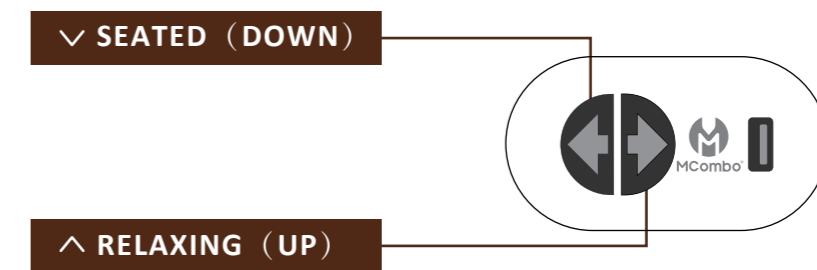

## IV. CARE AND MAINTENANCE

### Massage Remote Operation Instruction

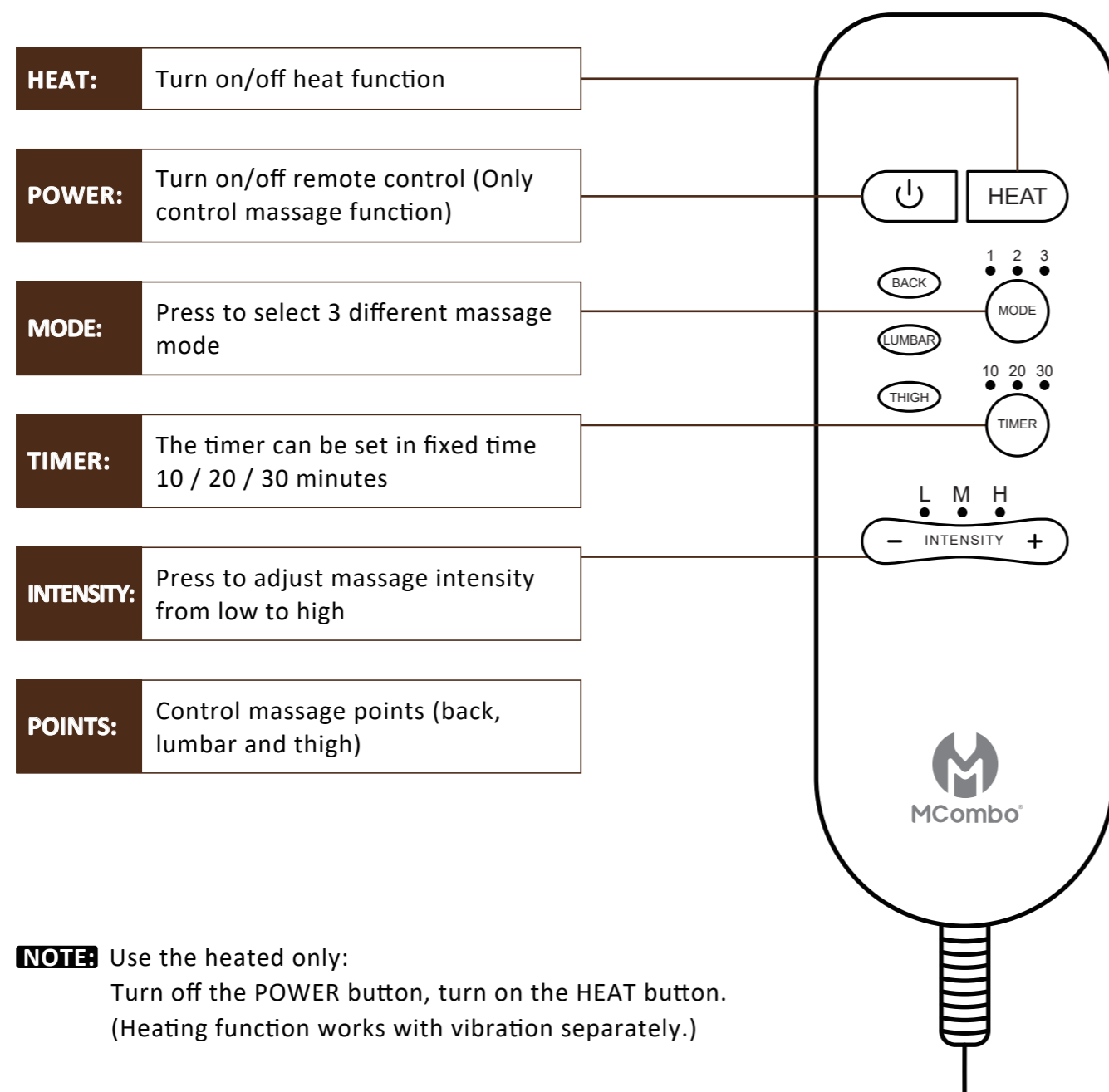

Your MCombo product will provide years of superior performance and satisfaction with regular care and maintenance. To maintain the finish quality of your "assistant", please follow the guidelines and cleaning procedures provided below.

#### ■ Notice

- Do not place the product in direct sunlight, as sunlight causes fading.
- Do not smoke cigarettes while seated in or using the product.
- Avoid extreme changes in temperature by arranging the product away from radiators, heat and air vents.
- Do not use solvent-type cleaners to spot clean.
- Do not saturate fabric.
- Please be careful that pet scratch may cause fabric or leather break.

### 1. Fabric Care

- Inspect the fabric on a regular basis for any pulls, tears, or gaps.
- Frequent vacuuming or light brushing with a nonmetallic, stiff bristle brush to remove dust and grime is recommended.
- When liquid spills onto the fabric, please immediately wipe off liquid spills with a dry or lightly dampened clean white cloth, sponge, or paper towel.

## 2. Faux Leather Care

- Wipe leather down regularly with a clean, dry microfiber cloth.
- For more stubborn dust, dampen the cloth with distilled water. Make sure that the cloth is not soaking wet. Never let water soak into leather.
- Always be sure to use a soft cloth and never use an abrasive brush or scrubber as this can scratch and damage the leather.

## 3. Electronics Care

- Inspect all wiring harnesses to make sure they are not damaged or stuck under the product.
- Keep all the electronics free from moisture and temperature extremes.
- Check electrical components frequently for signs of corrosion and replace as necessary.
- Contact MCombo Customer Support if damage is present, do not fix it by yourself.

## 4. Disposal & Recycling

Your power recliner sofa must be disposed of according to applicable local and national statutory disposal regulations. Contact your local waste disposal agency for information on proper disposal of recliner sofa packaging, metal/wood frame components, fabric, electronic components.

# V. TROUBLESHOOTING

The following troubleshooting FAQs should summarize what you need to know about your power recliner sofa. If at any time you do not feel comfortable performing the troubleshooting steps listed in this manual, please contact MCombo Customer Support for service.

Questions	Answers
<p><b>What if my power recliner sofa does not operate at all?</b></p>	<ul style="list-style-type: none"> <li>• Make sure all the connections are secured; refer to the Assembly Instructions.</li> <li>• Check all the electrical cords are not crimped or pinched.</li> <li>• Check if the light of the RED button at the back of the base is on.</li> <li>• Make sure the lights on the reclining control button and massage control are on.</li> </ul>
<p><b>What if the reclining function doesn't work?</b></p>	<ul style="list-style-type: none"> <li>• Make sure all the wires of the sofa are intact and connected properly.</li> <li>• Check if the RED light on the switch is on.</li> <li>• Make sure the lights of the massage remote are on.</li> <li>• Connect the power adapter, and massage remote, and backrest separately to the good side to test whether they work properly.</li> </ul>
<p><b>What if the massage and heat do not work?</b></p>	<ul style="list-style-type: none"> <li>• Make sure all the wires of the sofa are intact and connected properly.</li> <li>• Check if the RED light on the switch is on.</li> <li>• Make sure the lights of the massage remote are on.</li> <li>• Connect the power adapter, and massage remote, and backrest separately to the good side to test whether they work properly.</li> </ul>

Questions	Answers
<b>What if the USB charge ports do not work?</b>	<ul style="list-style-type: none"> <li>• Make sure the massage and reclining functions are both effective.</li> <li>• Make sure the USB cable coming out of the armrest is properly connected.</li> <li>• Check if the GREEN light on the USB charge port goes on.</li> </ul>
<b>What if the armrest falls apart from base?</b>	<ul style="list-style-type: none"> <li>• Ensure the two connections on each armrest are all inserted onto the base tightly.</li> <li>• Check the brackets of armrest and base to ensure there is no defects.</li> </ul>
<b>What if my recliner sofa makes a clicking noise?</b>	<ul style="list-style-type: none"> <li>• Check to make sure the product frame, motor and wiring are intact.</li> <li>• Make sure the weight capacity of 320 lbs has not been exceeded.</li> </ul>
<b>What if my recliner tilted to one side?</b>	<ul style="list-style-type: none"> <li>• Make sure the rack of recliner sofa is in a good condition without any distortion.</li> </ul>

**NOTE:**

If the product does not operate properly, please contact the MCombo Customer Support for help and never attempt to make any repairs or adjustments yourself.

## VI. DISASSEMBLY INSTRUCTION

**■ Notice**

- Ensure the product is in seated position and its footrest return to original position.
- Please unplug the power cord before disassembling.
- Please refer to the installation steps from back to front and disassemble the product in reverse order.

### Step1 - Disassemble Backrests

1. Pushing the metal ears of the backrest inserts outward (Refer to arrow direction).
2. After unlocking the metal lugs on both sides of the backrest, hold the bottom part of the backrest marked in the picture below and pull it vertically upward.

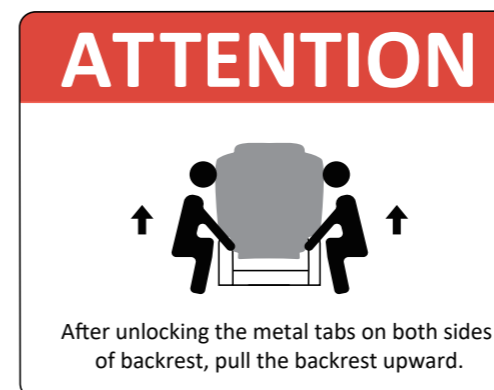
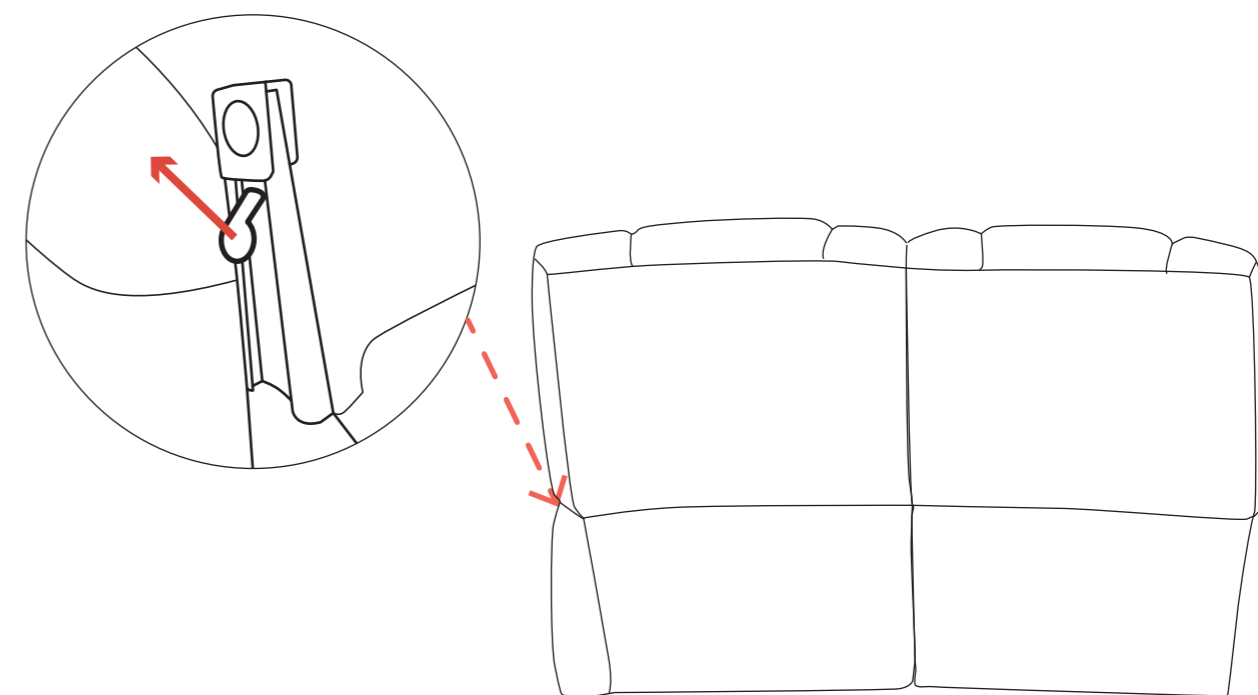

## Step2 - Disassemble Armrests

### ■ Notice

1. Need to remove the backrest first.
2. It is best to remove armrest by two people.
3. When lifting the armrest, be sure to hold the bottom of the armrest to avoid damaging the handrail bag and cup holder.

1. Use your knees to find a support point on the seat and press on the base with your own strength.
2. Hold the two marked positions at the bottom of the armrest and lift the armrest vertically upward.(Refer to arrow direction and the circular marking area.)

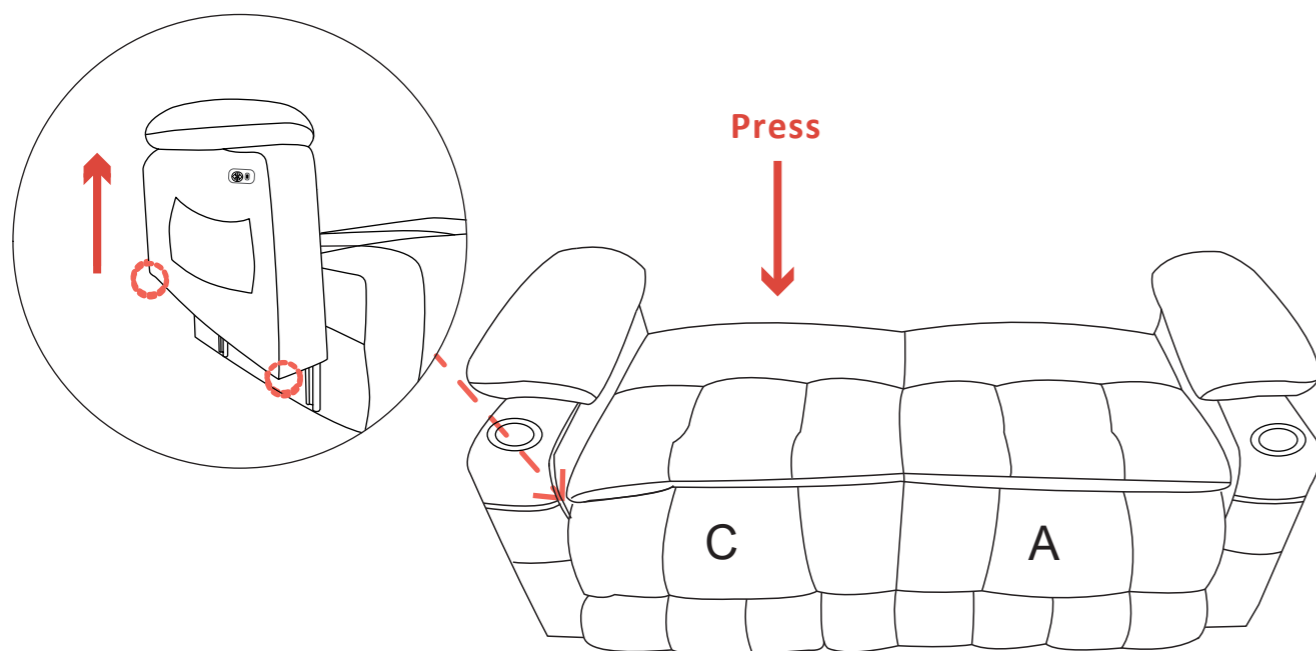

## VII. WARRANTY

### ■ Notice

- For product beyond the limited manufacturer warranty period and scope, MCombo® can also provide replacement service, but a basic charge will be charged according to the circumstances.
- The warranty only applies to MCombo® products and does not include any accessories or enhancements.
- Warranties are only valid in the 48 contiguous United States and are contingent upon the consumer operating the product according to the corresponding instruction manual.

Reclining Mechanism	★ 1 Year
Upholstery Material	★ 1 Year
Metal/ Wood Frame	★ 1 Year
Electronic Parts	★ 1 Year

### CONSUMER WARRANTY LIMITATIONS AND EXCLUSIONS

All warranties begin on the date of delivery.

All warranties are to the original purchaser from MCOMBO® ONLY.

- MCOMBO® will replace the defective parts or send replacement product provided that the warranty parts have not been subjected to misuse, abuse or improper service by the consumer, for example, damaged wire arising in consequence of negligence or improper operation.
- Exclusions also include components with damage caused by:
  - Contamination
  - Abuse, misuse, accident, or negligence
  - Commercial use, or use other than normal
  - Improper operation, maintenance, or storage

### NOTE:

MCOMBO® will pay standard shipping rates on all warranted parts for the first year. We can also sell you replacement part for a discount price when your product is out of warranty policy.