

Aluminum Outdoor Combination Sofa 4-piece Set

If you have any questions about the outdoor combination sofa, please feel free to contact us.

Customer Service Email: Service@alaulm.com

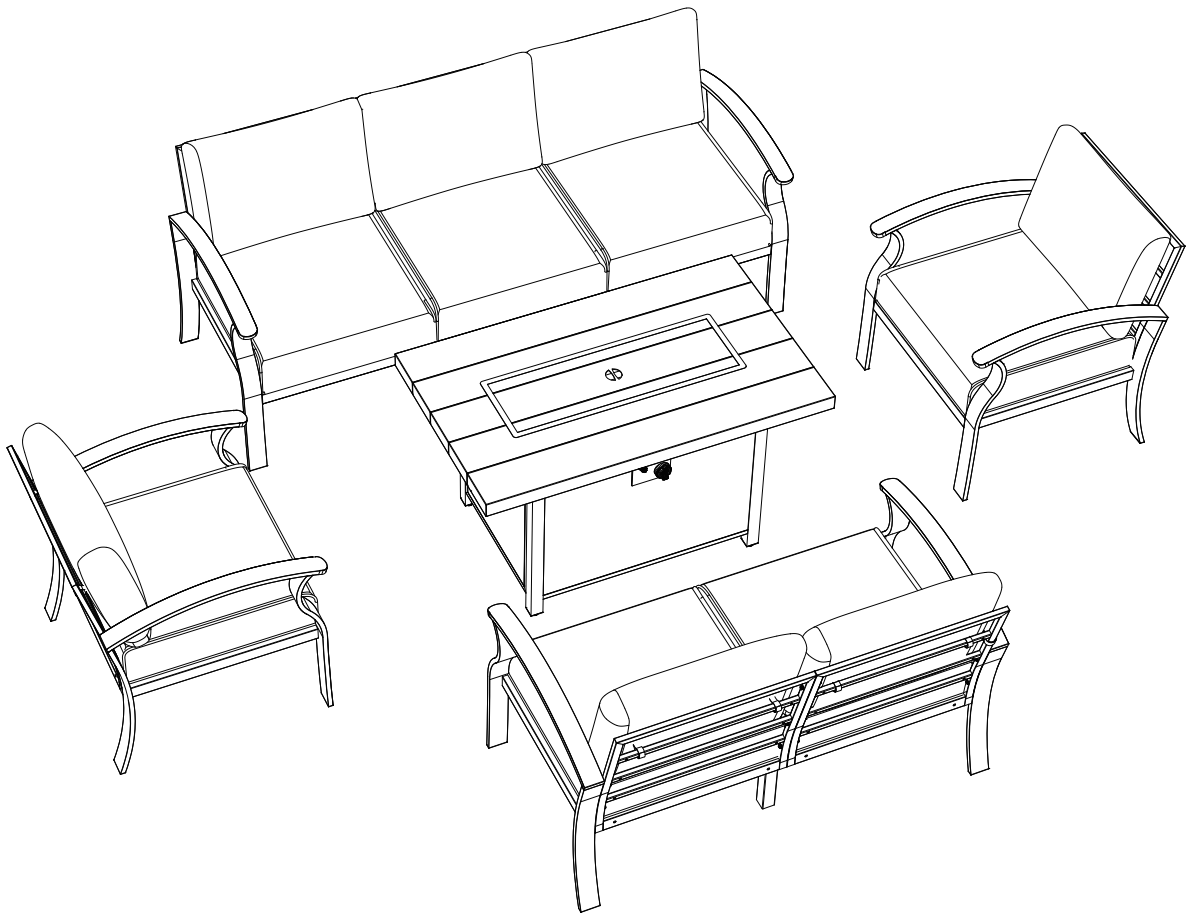

AluDASF23

IMPORTANT

PLEASE READ BEFORE YOU COMMENCE ASSEMBLY

Follow the guidelines in this user guide to ensure correct
assembly and care for this product.

SPECIFICATIONS

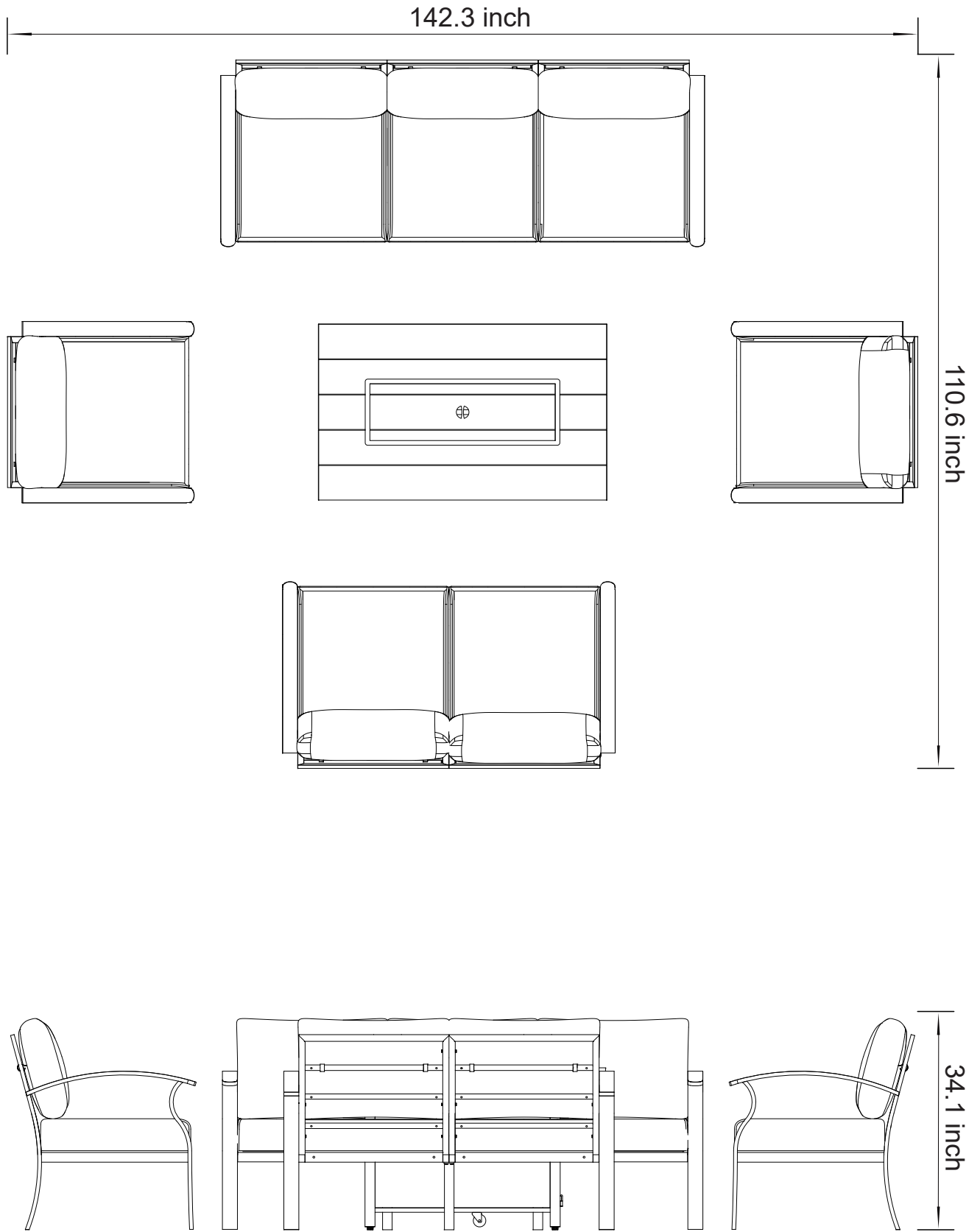

Catalog

Specifications.....	01
Before you begin.....	03
Part List And Extra	04
How to Assemble Single Sofa.....	08
How to Assemble Double Sofa	11
How to Assemble The Three-person Sofa	16
How to Use The Seat Cushions And Pillows.....	21
Cushion Manual	22



Before You Begin

Assembly Instructions:

Instructions are supplied in this manual and contain all appropriate information for your building model.

Review all instructions before you begin and during assembly, follow the step sequence carefully for correct results.

Parts and Parts List:

Check to be sure that you have all the necessary parts for building.

Separate contents of the carton by the part number while reviewing parts list.

Familiarize yourself with the hardware and fasteners for easier use during construction.







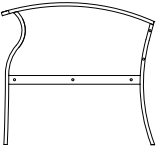
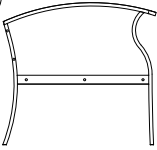
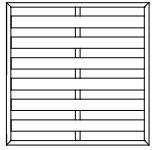

The first few steps show how to join related parts which is to obtain larger sub-assemblies be used later.

All parts are packaged within the carton.

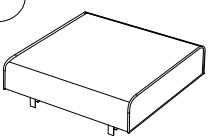
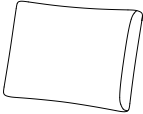

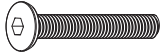

Note that extra fasteners have been supplied for your convenience.

PART LIST



Parts List (Box A)

 A Left Sofa Armrest	 B Right Sofa Armrest	 C Base Plate	 D Sofa Backrest	 F Cushions
2 PCS	2 PCS	2 PCS	2 PCS	2 PCS
 G Pillows	 H2 M6x30	 H3 M6x40	 I Metal Gasket	 K Screw Caps
2 PCS	4 PCS	20 PCS	24 PCS	24 PCS
 M Hole Cover	 N Universal wrench			
8 PCS	1 PC			





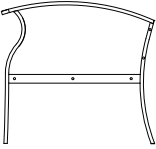
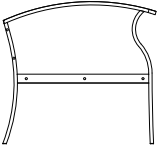
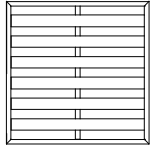

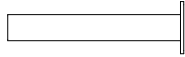



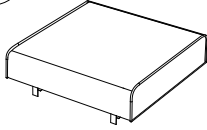
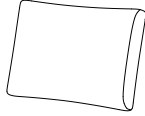
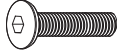

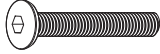



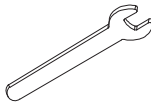
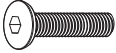

Extra (Box A)

 H2 M6x30	 H3 M6x40	 I Metal Gasket	 K Screw Caps	 M Hole Cover
1 PC	2 PCS	2 PCS	2 PCS	1 PC

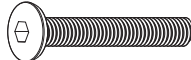









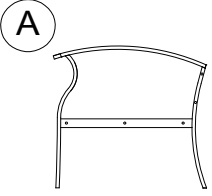
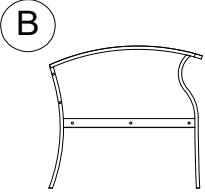
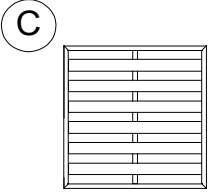
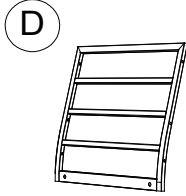
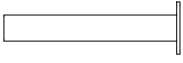
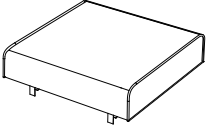
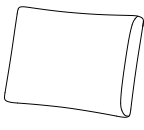
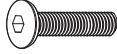

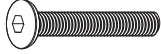
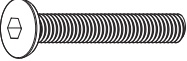
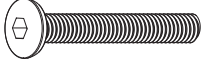
Parts List (Box B)

 A Left Sofa Armrest	 B Right Sofa Armrest	 C Base Plate	 D Sofa Backrest	 E Sofa Legs
1 PC	1 PC	2 PCS	2 PCS	2 PCS

PART LIST

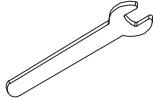

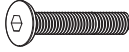
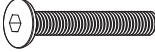

Parts List (Box B)				
 <p>Cushions</p>	 <p>Pillows</p>	 <p>M6x20</p>	 <p>M6x30</p>	 <p>M6x40</p>
2 PCS	2 PCS	8 PCS	4 PCS	10 PCS
 <p>M6x50</p>	 <p>M6x60</p>	 <p>Metal Gasket</p>	 <p>M6</p>	 <p>Screw Caps</p>
3 PCS	3 PCS	28 PCS	6 PCS	28 PCS
 <p>Nut Caps</p>	 <p>Hole Cover</p>	 <p>Universal wrench</p>	 <p>Open-end wrench</p>	
6 PCS	4 PCS	1 PC	1 PC	
Extra (Box B)				
 <p>M6x20</p>	 <p>M6x30</p>	 <p>M6x40</p>	 <p>M6x50</p>	 <p>M6x60</p>
2 PCS	1 PC	2 PCS	1 PC	1 PC
 <p>Metal Gasket</p>	 <p>M6</p>	 <p>Screw Caps</p>	 <p>Nut Caps</p>	 <p>Hole Cover</p>
2 PCS	2 PCS	2 PCS	1 PC	1 PC

PART LIST

Parts List (Box C)				
 <p>Left Sofa Armrest</p>	 <p>Right Sofa Armrest</p>	 <p>Base Plate</p>	 <p>Sofa Backrest</p>	 <p>Sofa Legs</p>
1 PC	1 PC	3 PCS	3 PCS	4 PCS
 <p>Cushions</p>	 <p>Pillows</p>	 <p>M6x20</p>	 <p>M6x30</p>	 <p>M6x40</p>
3 PCS	3 PCS	16 PCS	6 PCS	10 PCS
 <p>M6x50</p>	 <p>M6x60</p>	 <p>Metal Gasket</p>	 <p>M6</p>	 <p>Screw Caps</p>
6 PCS	6 PCS	44 PCS	12 PCS	44 PCS
 <p>Nut Caps</p>	 <p>Hole Cover</p>	 <p>Universal wrench</p>	 <p>Open-end wrench</p>	
12 PCS	4 PCS	1 PC	1 PC	
Extra (Box C)				
 <p>M6x20</p>	 <p>M6x30</p>	 <p>M6x40</p>	 <p>M6x50</p>	 <p>M6x60</p>
2 PCS	1 PC	2 PCS	1 PC	1 PC

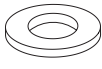
PART LIST

Extra (Box C)

<p>I</p>  <p>Metal Gasket</p>	<p>J</p>  <p>M6</p>	<p>K</p>  <p>Screw Caps</p>	<p>L</p>  <p>Nut Caps</p>	<p>M</p>  <p>Hole Cover</p>
<p>4 PCS</p>	<p>2 PCS</p>	<p>4 PCS</p>	<p>2 PCS</p>	<p>1 PC</p>

How To Assemble Single Sofa

Step 1: Attach the base plate(C) to the sofa backrest(D) with screws(H2).

NOTE: Do not tighten the screws all the way.

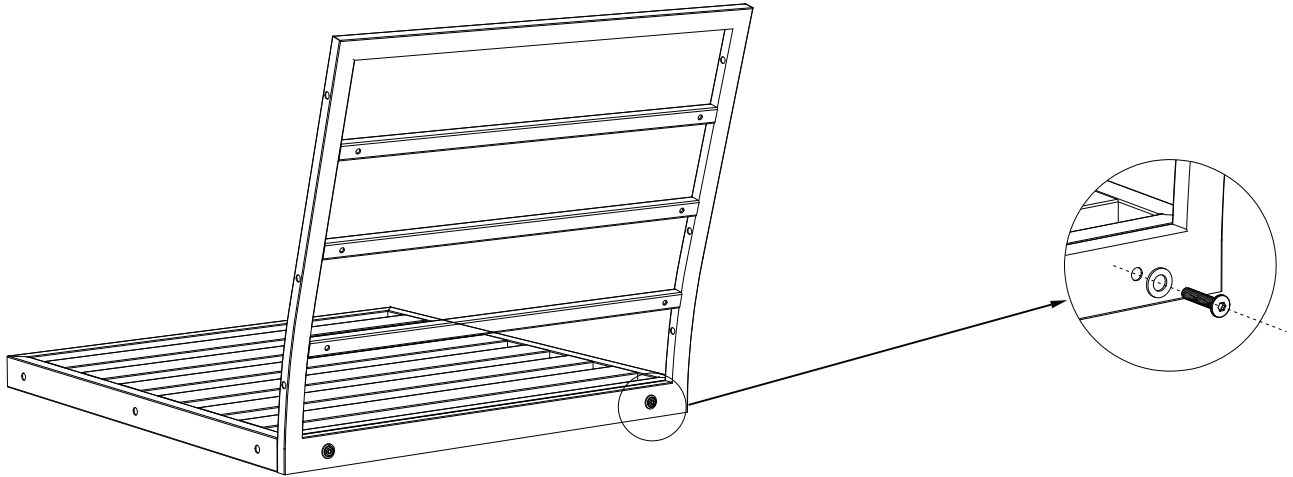

C		x2	D		x2	H2		M6*30	x4
						I		x4	

Step 2: Connect the left sofa armrest(A) of the sofa to the base plate(C) and backrest(D) with screws(H3).

NOTE: Do not tighten the screws all the way.

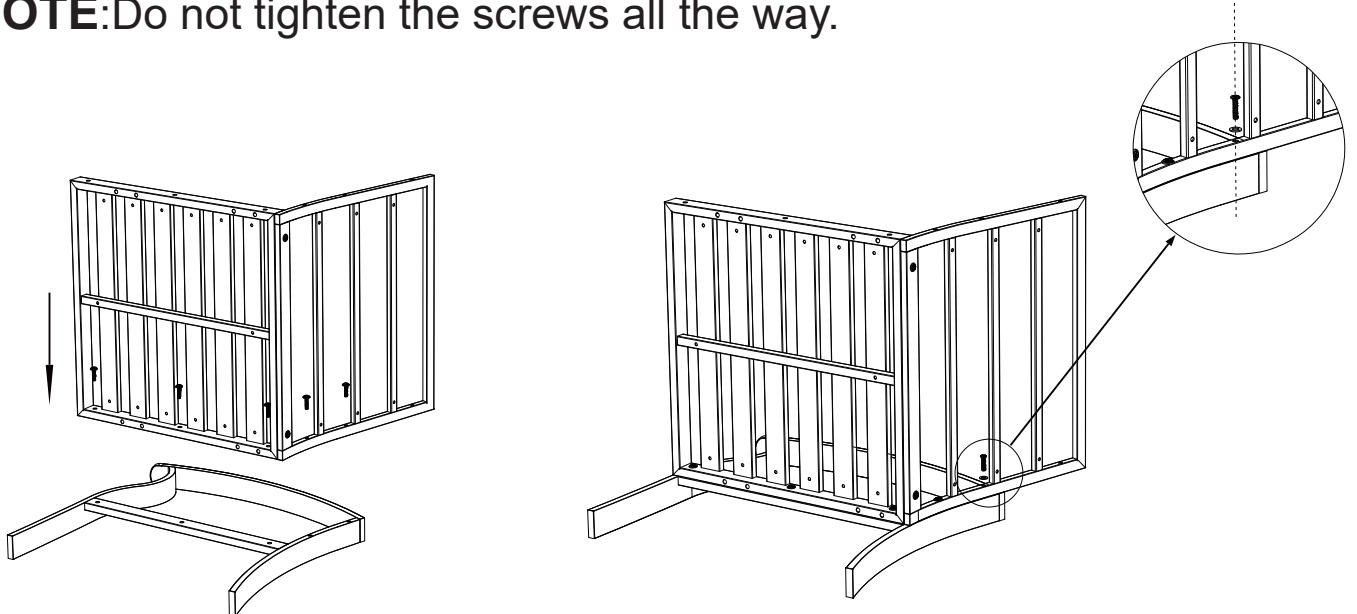

A		x2	H3		M6*40	x10
			I		x10	

Installation steps

Step 3: Connect the right sofa armrest(B) of the sofa to the base plate (C) and backrest(D) with screws(H3).

NOTE: Please tighten all screws.

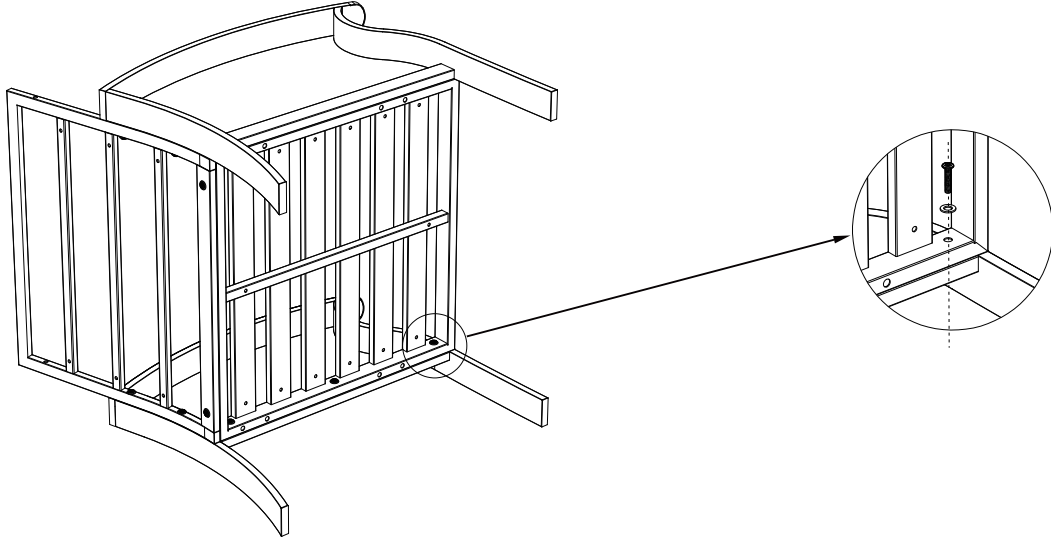

B

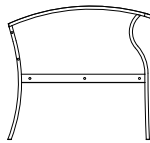

x2

H3  M6*40 x10

I  x10

Step 4: Insert the hole cover(M) into the free screw hole above the backrest.

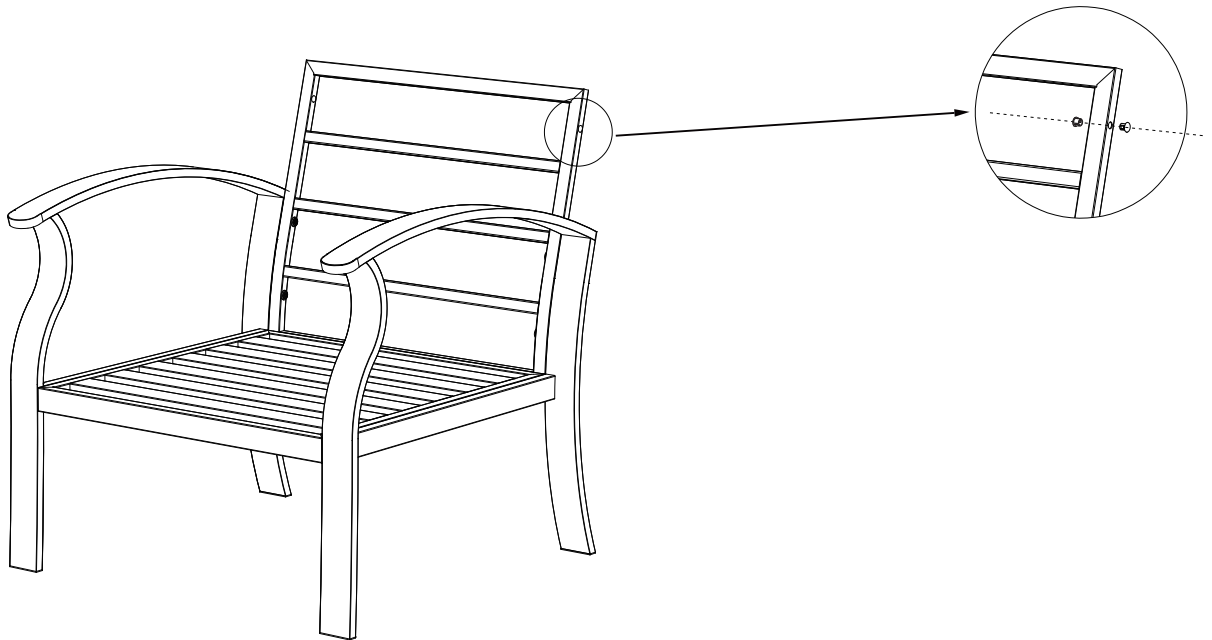

M



x8

Installation steps

Step 5: Put the screw cap(K) on the screw.

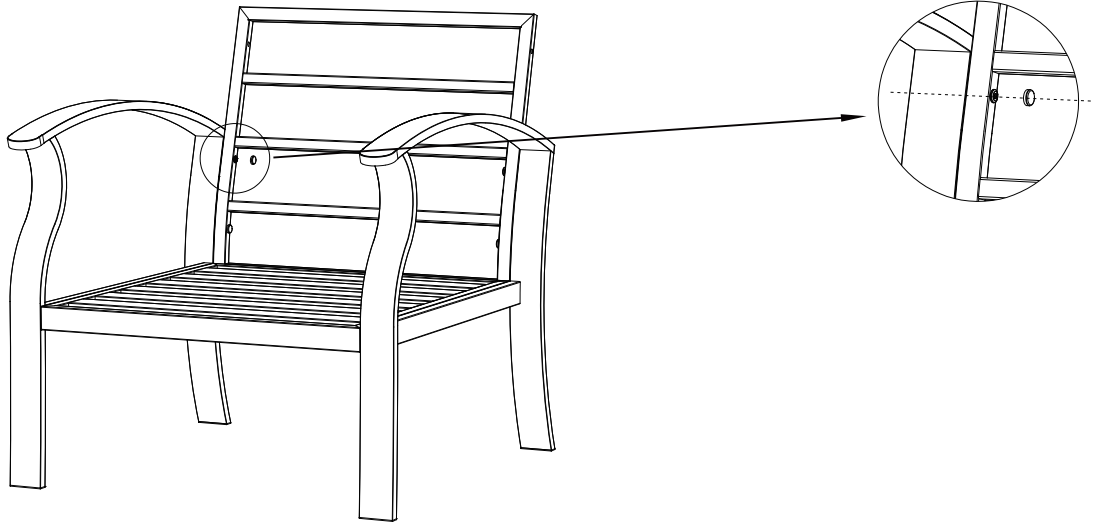

K







x24

How To Assemble Double Sofa

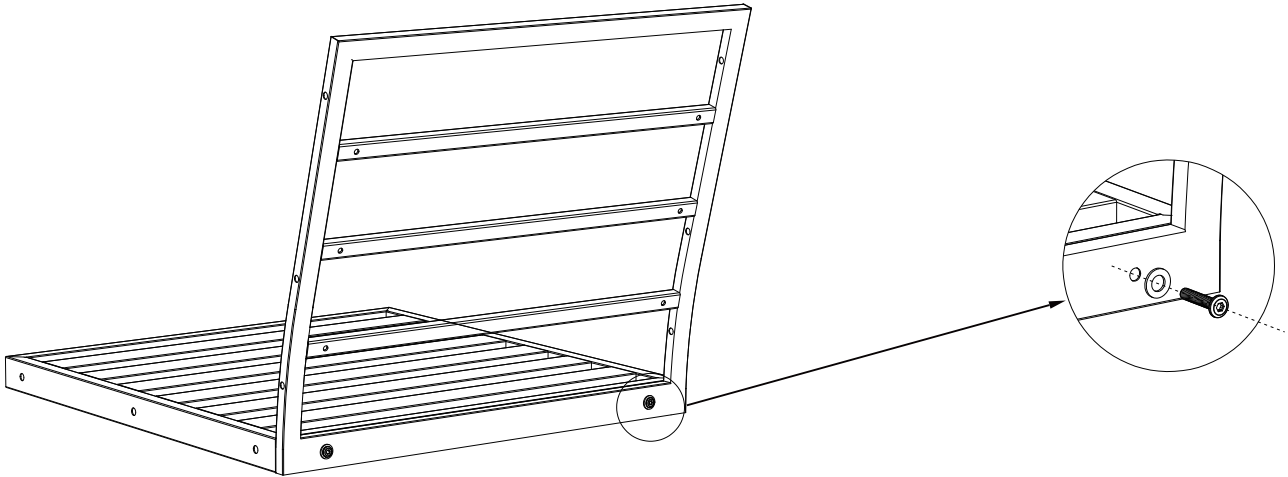
Step 1: Attach the base plate(C) to the sofa backrest(D) with screws(H2).

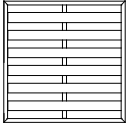
NOTE: Do not tighten the screws all the way.





C		x2	D		x2	H2		M6*30	x4
						I		x4	

Step 2: Connect the left and right sofa seat plates with screws(H4).

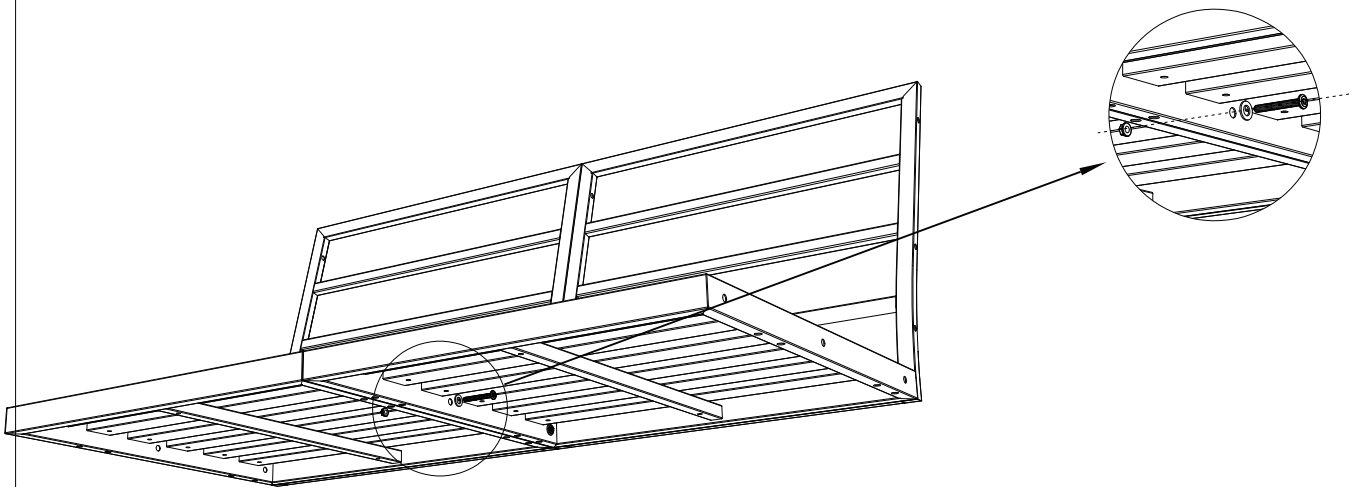
NOTE: Do not tighten the screws all the way.



H4		M6*50	x3	I		x3	J		M6	x3
----	---	-------	----	---	---	----	---	---	----	----

Installation steps

Step 3: Connect the left and right sofa backrests with screws(H5).
NOTE: Please tighten all screws.

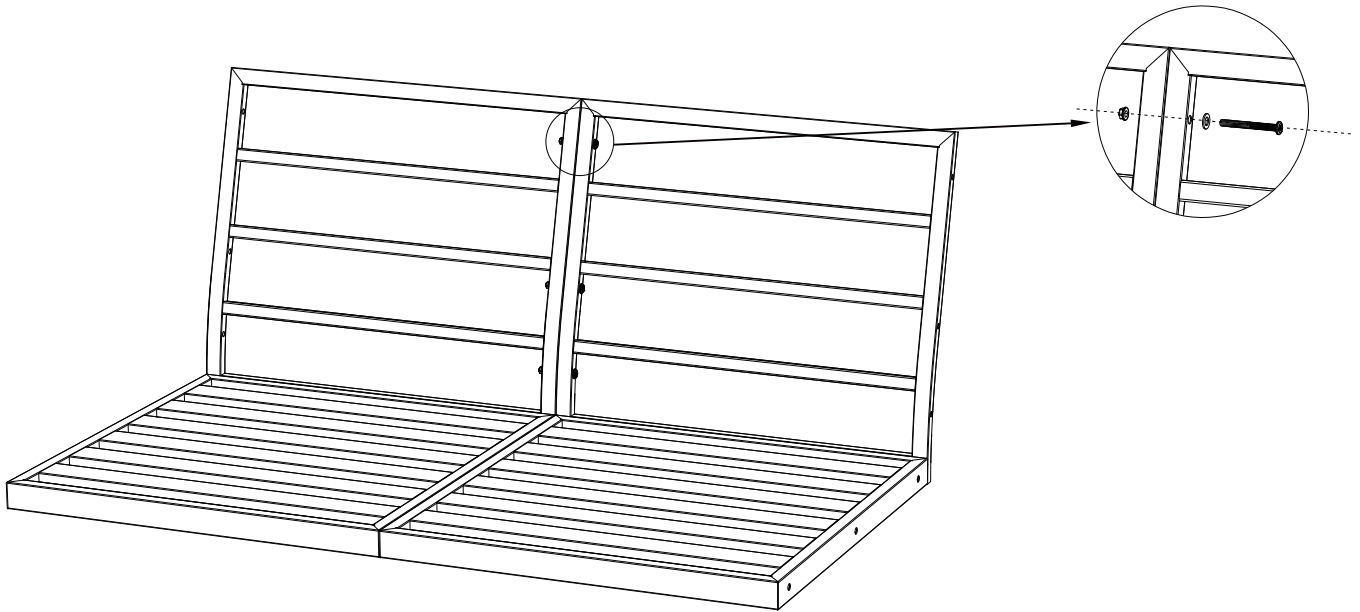

H5	 M6*60	x3	I		x3	J	 M6	x3
----	---	----	---	---	----	---	--	----

Step 4: Connect the left sofa armrest(A) of the sofa to the base plate(C) and backrest(D) with screws(H3).

NOTE: Do not tighten the screws all the way.

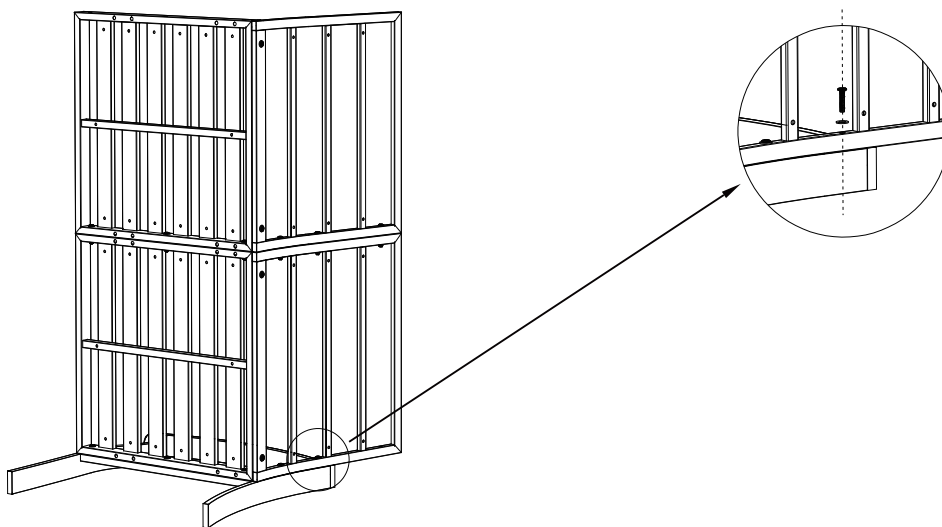

A		x1	H3	 M6*40	x5
			I		x5

Installation steps

Step 5: Connect the right sofa armrest(B) of the sofa to the base plate (C) and backrest(D) with screws(H3).

NOTE: Please tighten all screws.

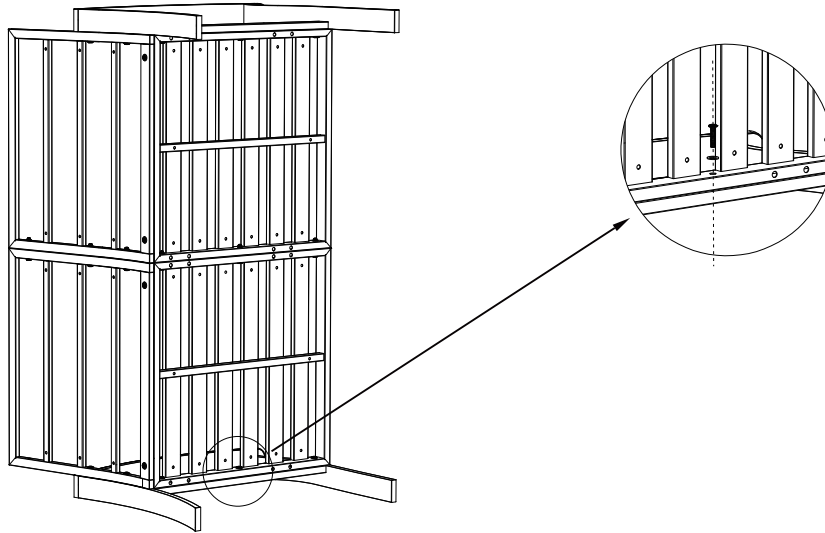

B		x1	H3		M6*40	x5
			I			x5

Step 6: Attach the sofa legs(E) to the sofa base with screws(H1).

NOTE: Please tighten all screws.

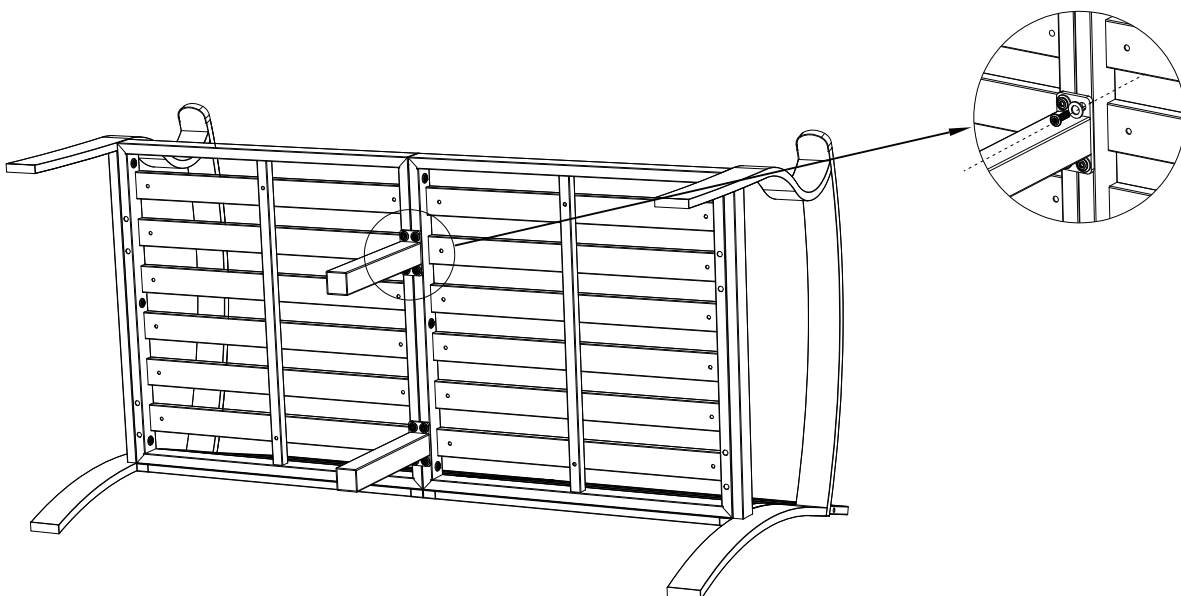

E		x2	H1		M6*20	x8	I		x8
---	--	----	----	--	-------	----	---	--	----

Installation steps

Step 7: Insert the hole cover (M) into the free screw hole above the backrest.

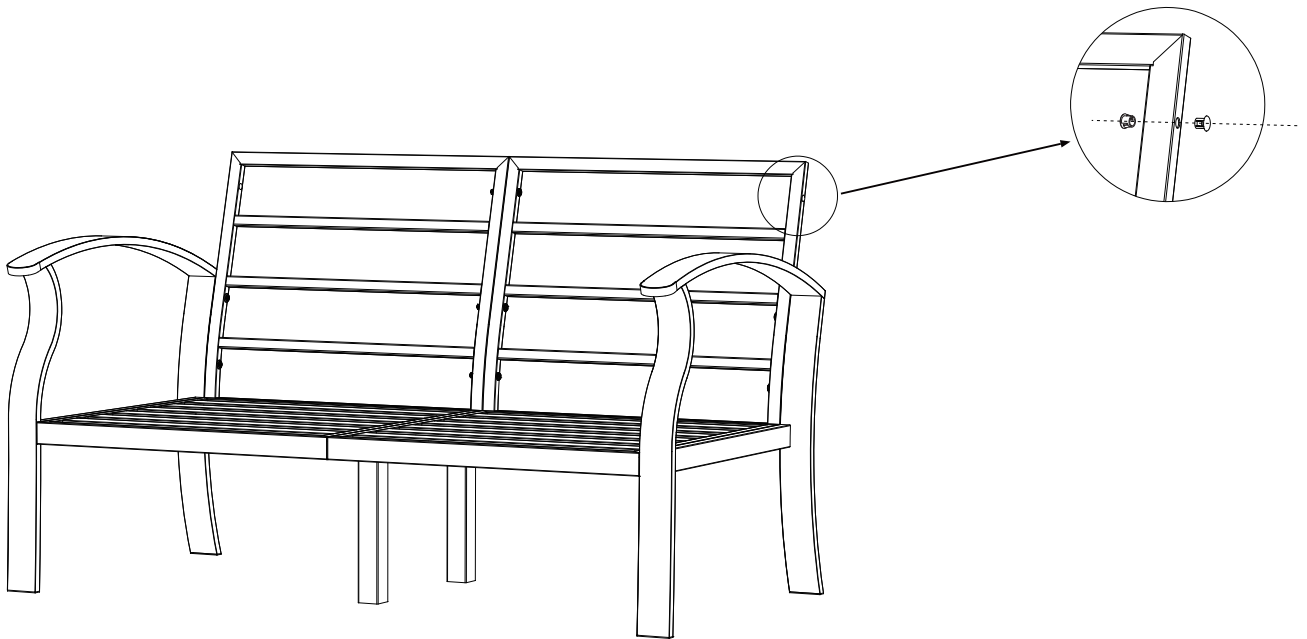

M



x4

Step 8: Put the screw cap (K) on the screw.

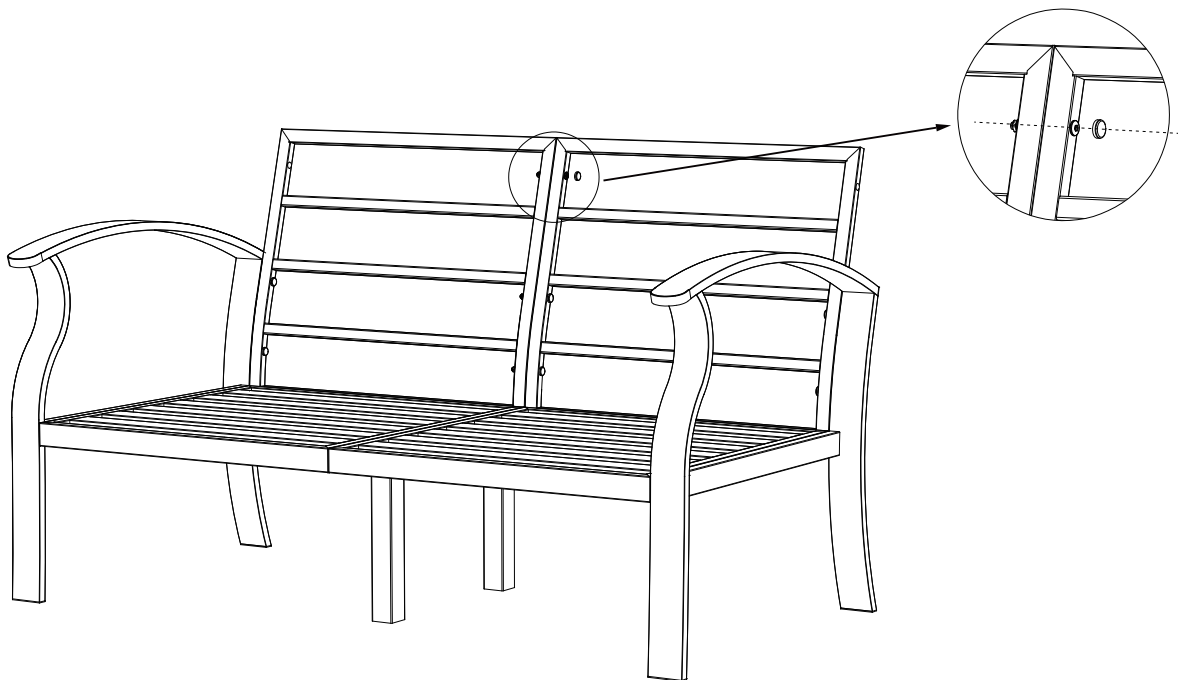

K



x28

Installation steps

Step 9: Put the nut cap(L) on the nut.

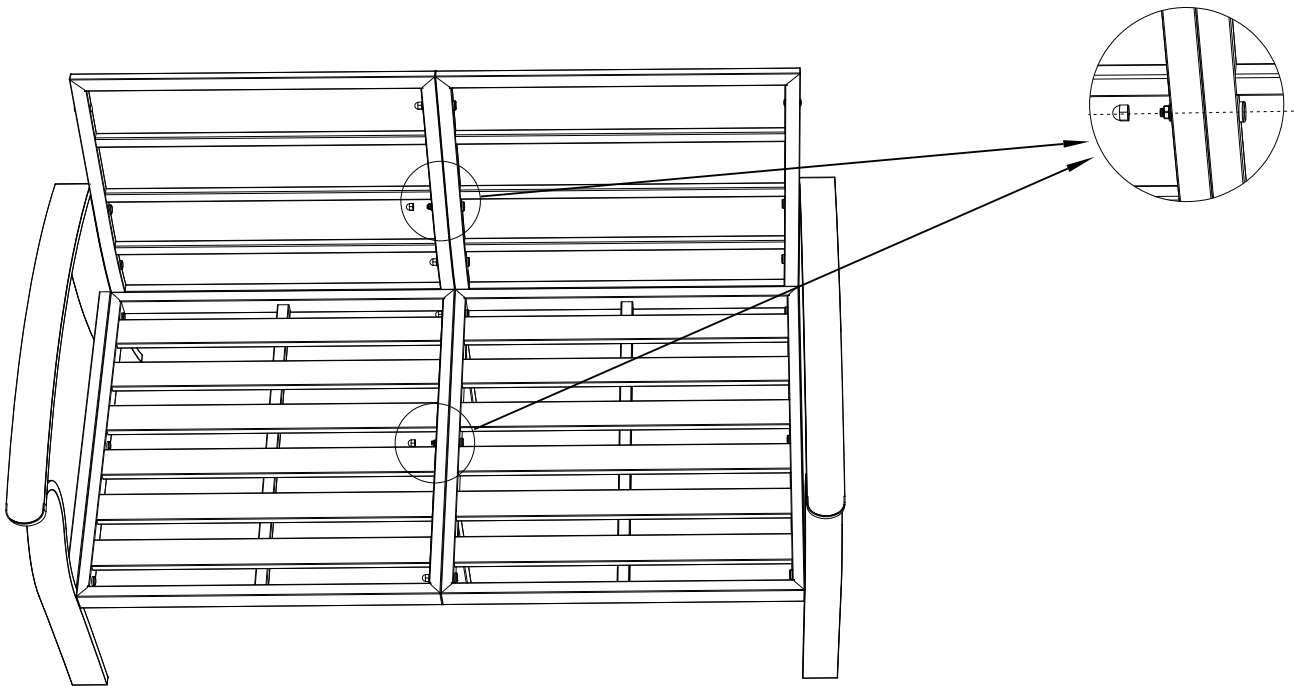

L



x6

How To Assemble The Three-person Sofa

Step 1: Attach the base plate(C) to the sofa backrest(D) with screws(H2).

NOTE: Do not tighten the screws all the way.

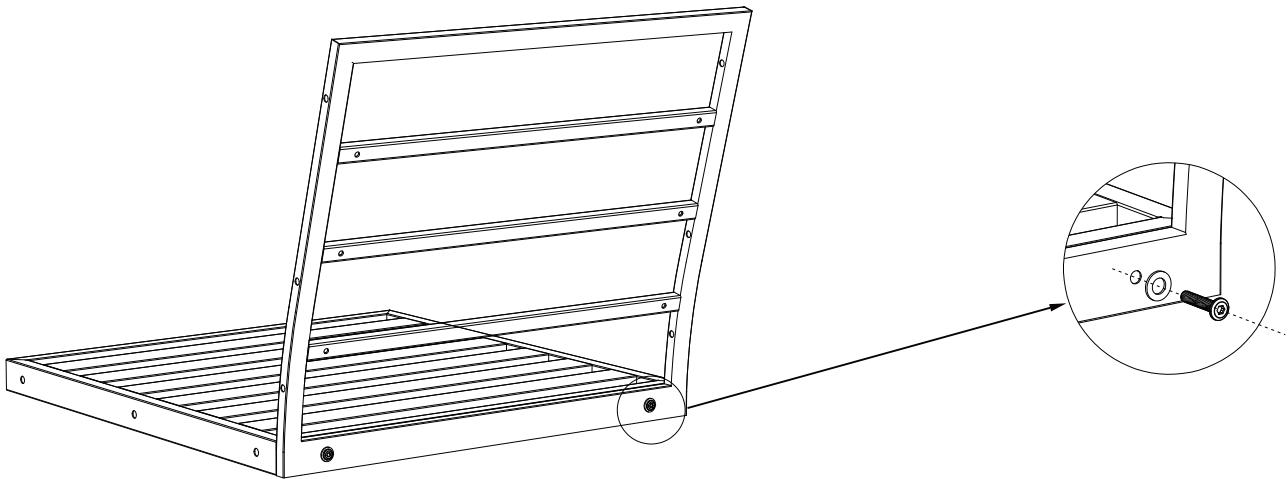

C

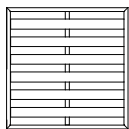

x3

D



x3

H2



x6

I



x6

Step 2: Connect the sofa seat plates with screws(H4).

NOTE: Do not tighten the screws all the way.

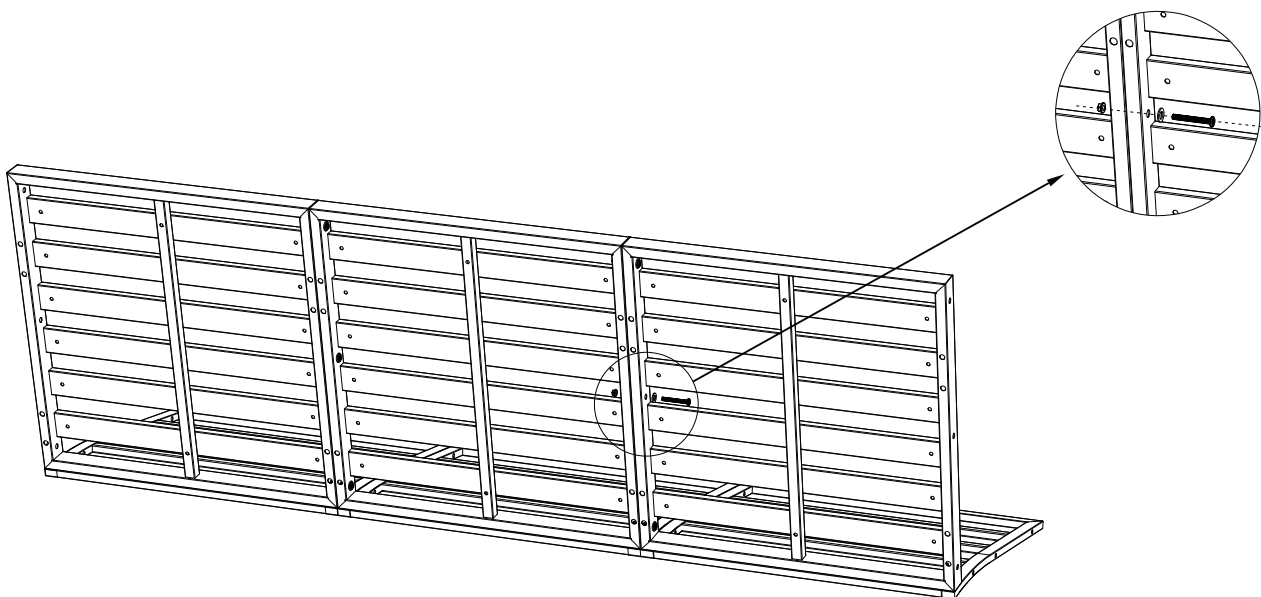

H4



x6

I



x6

J







x6

Installation steps

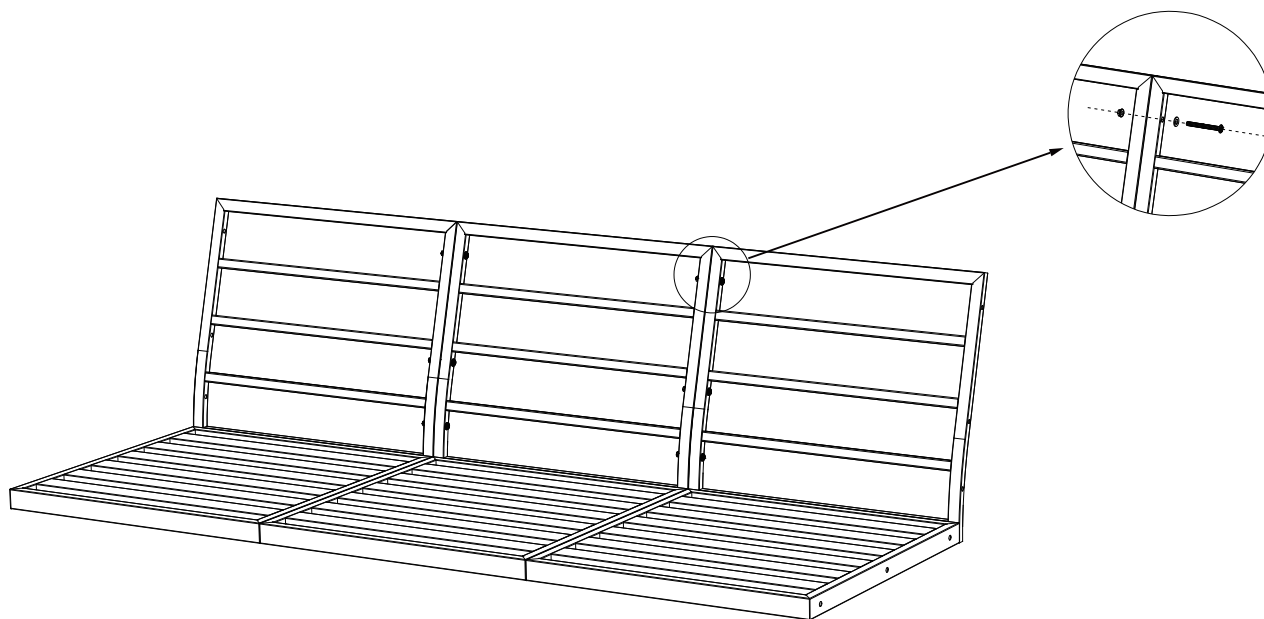
Step 3: Connect the sofa backrest with screws(H5).

NOTE: Do not tighten the screws all the way.





H5	 M6*60	x6	I		x6	J	 M6	x6
----	---	----	---	---	----	---	--	----

Step 4: Connect the sofa armrest(A and B) of the sofa to the base plate (C) and backrest(D) with screws(H3).

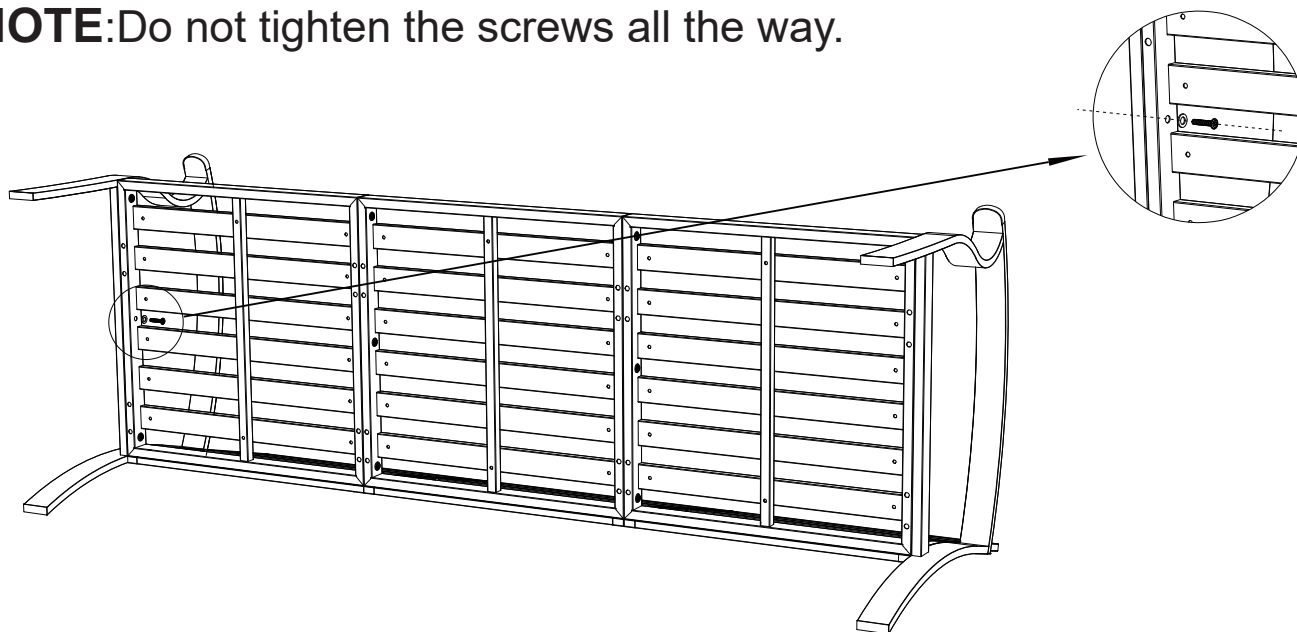
NOTE: Do not tighten the screws all the way.

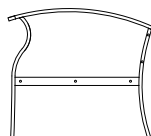
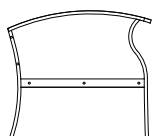

A		x1	B		x1	H3	 M6*40	x6
						I		x6

Installation steps

Step 5: Connect the sofa armrest(A and B) of the sofa to the base plate (C) and backrest(D) with screws(H3).

NOTE: Do not tighten the screws all the way.

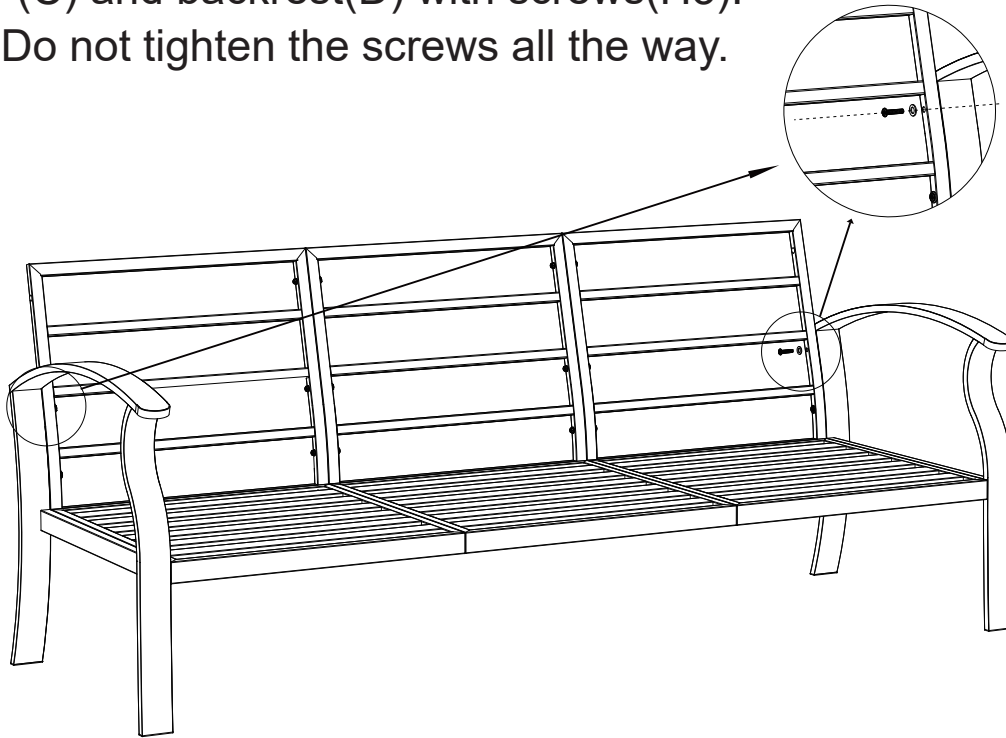

H3



x4

I



x4

Step 6: Attach the sofa legs(E) to the sofa base with screws(H1).

NOTE: Please tighten all screws.

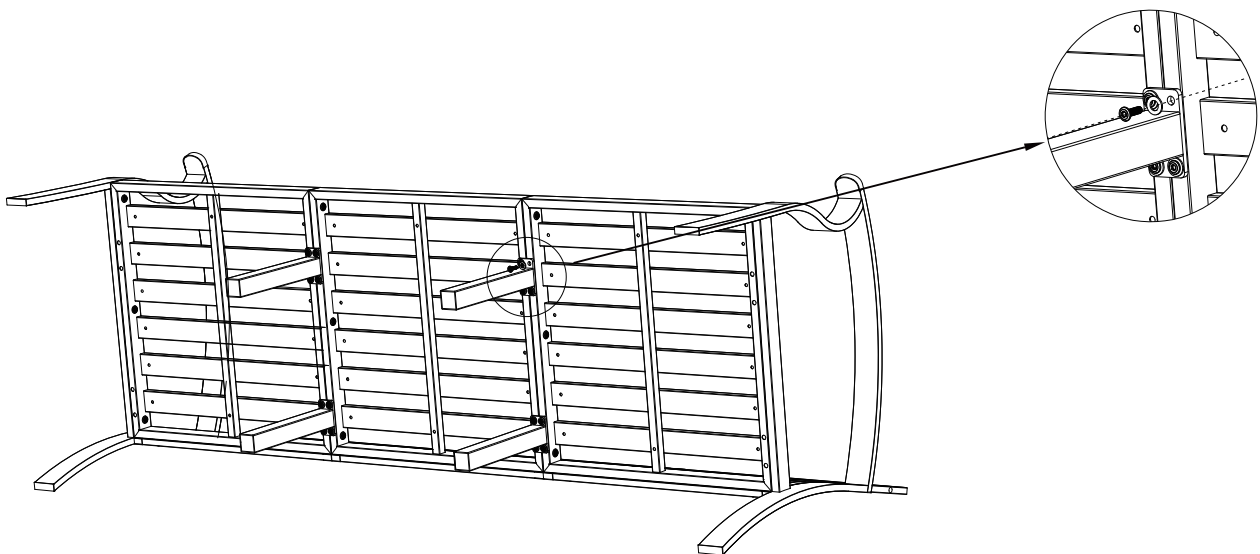

E

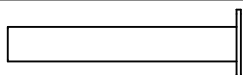

x4

H1



I



x16

Installation steps

Step 7: Insert the hole cover(M) into the free screw hole above the backrest.

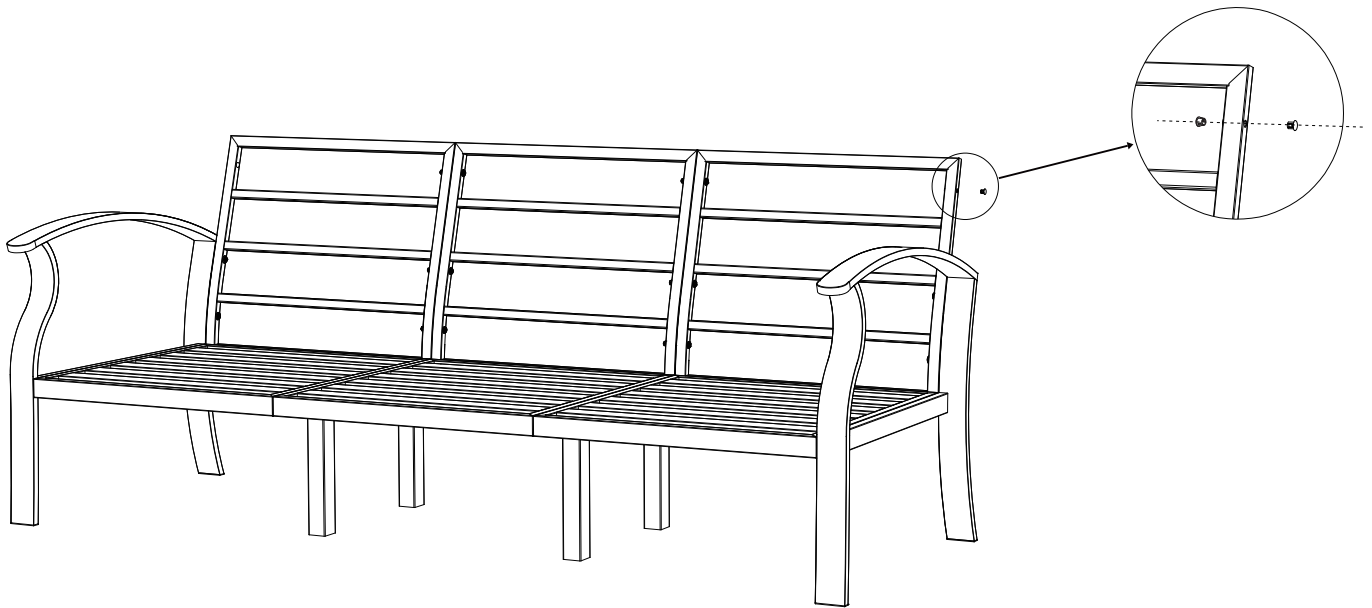

M



x4

Step 8: Put the screw cap(K) on the screw.

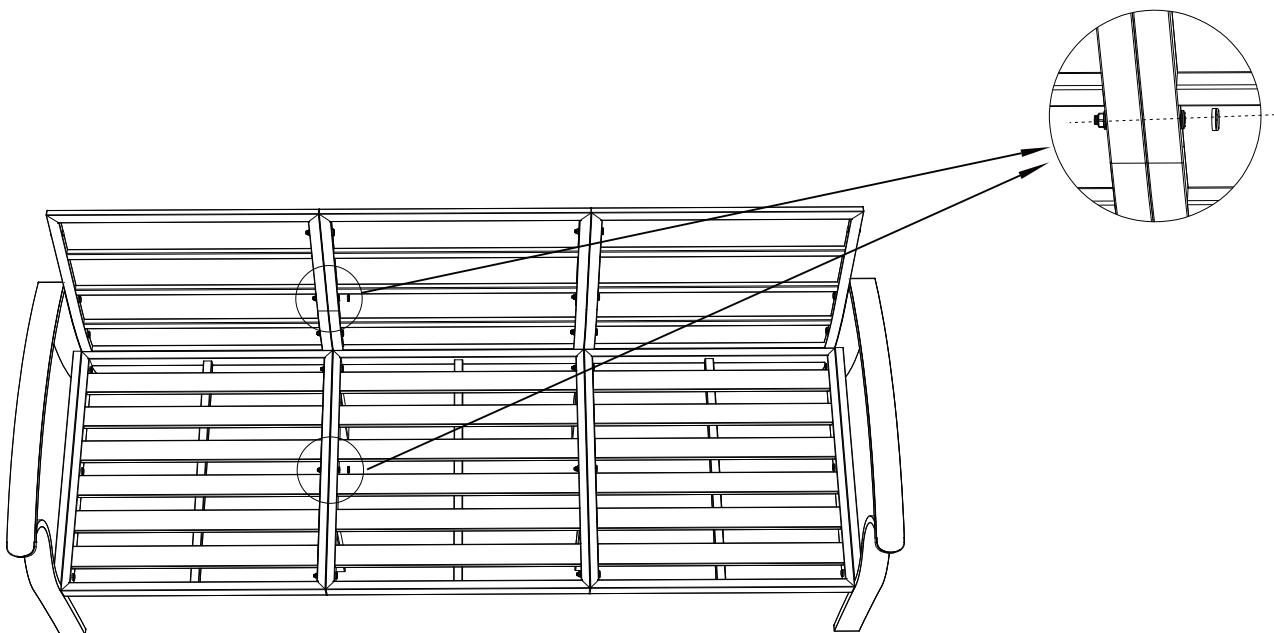

K



x44

Installation steps

Step 9: Put the nut cap(L) on the nuts.

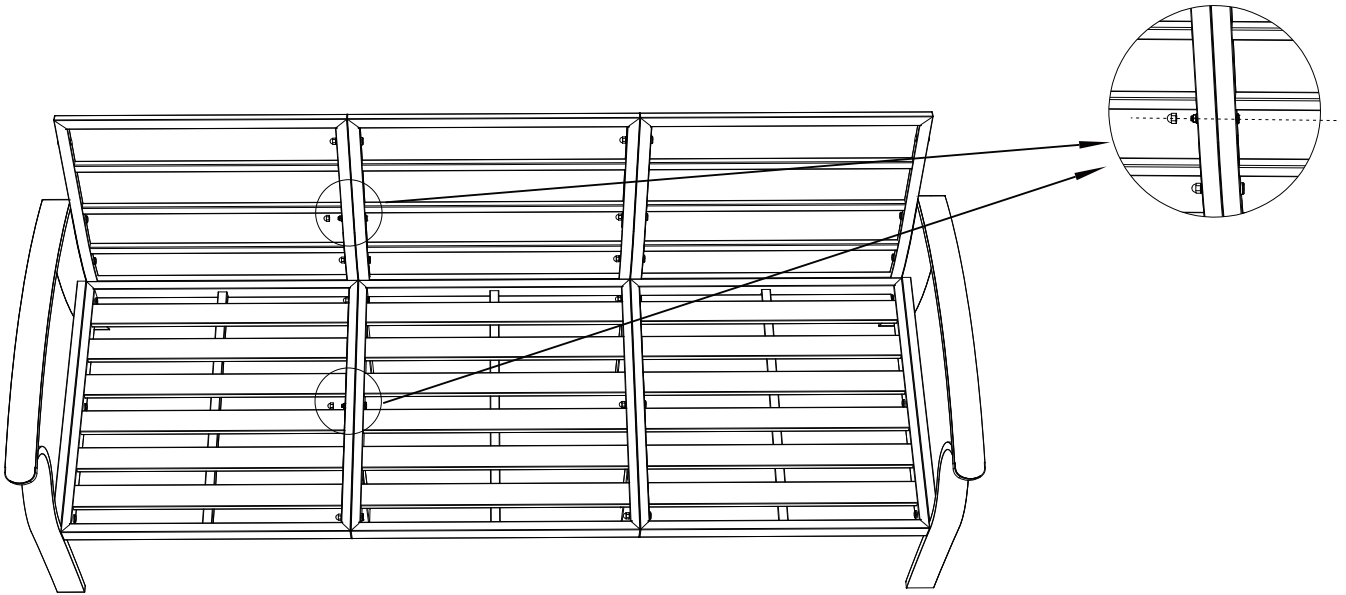

L



x12

How To Use The Seat Cushions And Pillows

Step 1: Put the seat cushions(F) on the seat plate, stick the velcro under the seat cushions.

NOTE: Pay attention to the front and rear placement of the seat cushions.

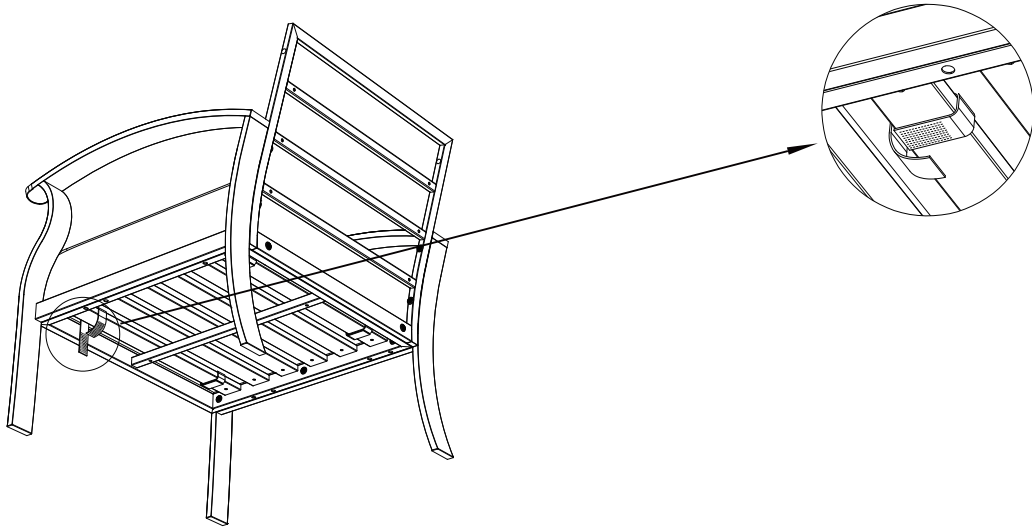

F

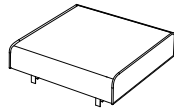

x7

Step 2: Put the pillows(G) on the backrest of the sofa and stick the velcro.

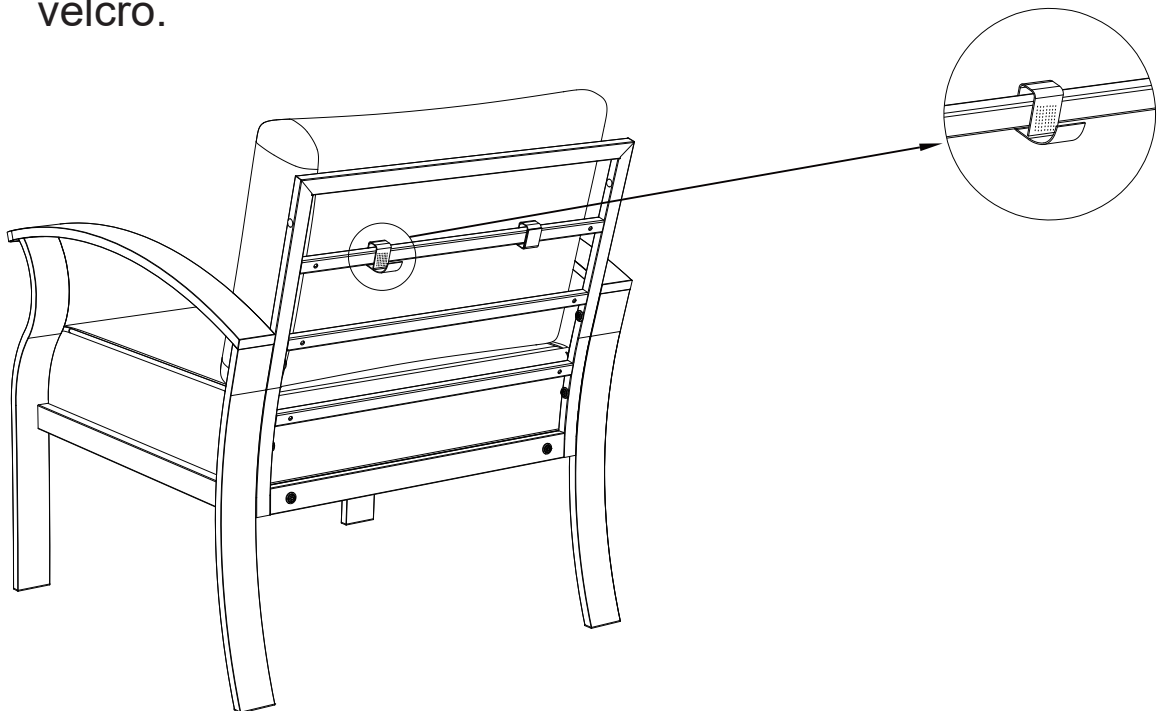

G



x7

Cushion Manual



7pcs white foam for seat cushion
7pcs PP cotton filler for back cushion



7pcs back cushion covers



7pcs seat cushion covers



Open cushion filler packing



Put the cushion filler inside the cover



Back Cushion



Open seat cushion
white foam packing



Put the white foam
inside the cover



Seat Cushion

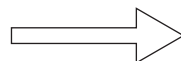

7pcs back cushions

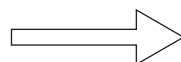

7pcs seat cushions

Please Note:

Because the cushion and pillow infilling is vacuum packed, So after you open the bag and put them into the covers, The springback of the PP cotton of pillow need some more time than the white foam cushion, usually need 3-4 days. It can make the time shorter if slapping the pillows with the palm or other flat object.