

# BATHTUB INSTALLATION INSTRUCTION

NOTE: Due to the nature of the material, models can differ up to 0.79" from the listed dimensions.

PACKING LIST  
- Bathtub  
- Drain Pipe

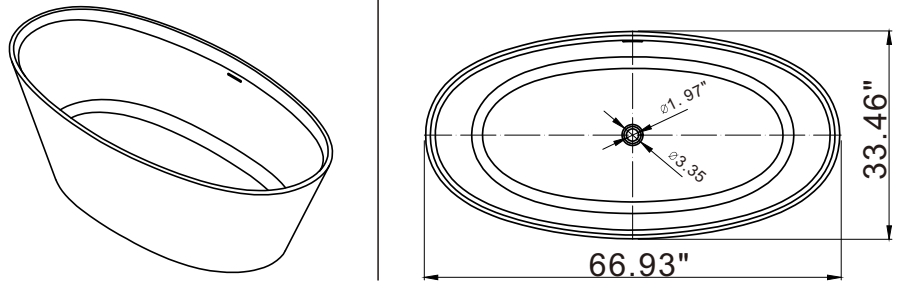

## NOMINAL DIMENSIONS

MODEL#	BATHTUB SIZE
B11776	66.93x33.46x21.65inch

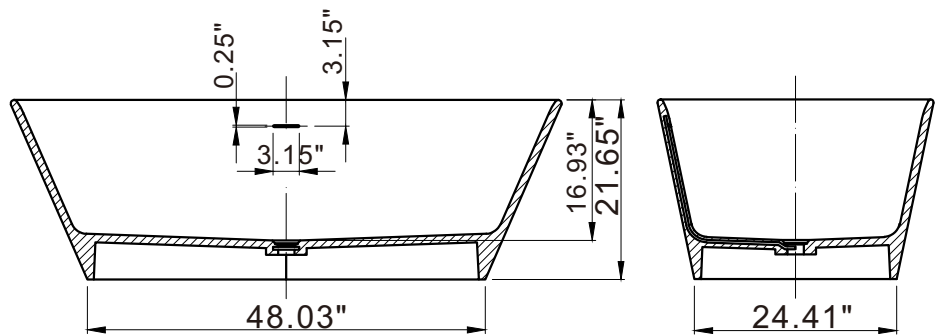

## Installation step diagram

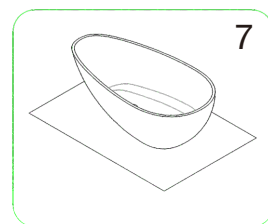
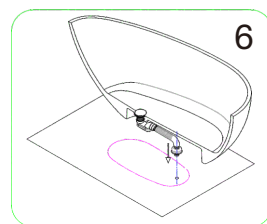
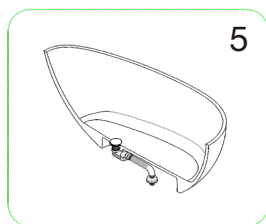
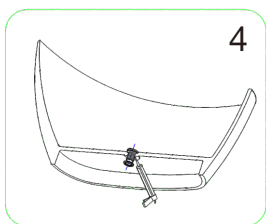
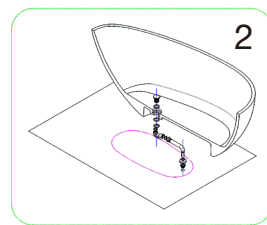
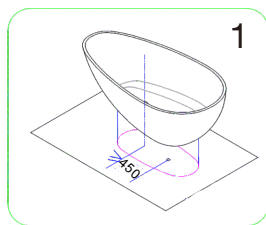
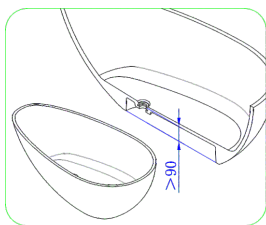

# CARE AND MAINTENANCE

---



## ALWAYS

- Clean every day by thoroughly rinsing with a mild soap and warm water and wipe dry.
- Always rinse the tub after using any cleaning agent and wipe dry.
- Keep the tub free of any standing water as this can cause water stains and water scale, which can affect the appearance of your tub.



## NEVER

- Use steel wool, sharp objects or sharp tools as they damage the tub surface.
- Let household cleaning agents or bleach sit in your tub for a long period of time as this may ruin the finish of your tub.
- Leave rubber mats, sponges, or cleaning pads in the tub for long period of time as this may ruin the finish of your tub.
- Leave the colored substances such as make-up, hair dye, and coloring agents on the surface of the bathtub for a long time, as this may stain the bathtub.
- Use the inside of the tub as cutting surface.
- Use sand paper to polish the outside rubber painting color.
- Use something hard or rough to clean transparent resin stone bathtub as this may damage the surface of the bathtub.