

STATESMAN

kitchen appliances



SKAF05015BK
5 LITRE DIGITAL AIR FRYER

Instruction Manual

Please read these instructions carefully before use and retain for future reference.
Before switching on your appliance – Always check for any damage that may have
been caused in transit.

CONTENTS

Important Safety Instructions	3-5
Air Frying Tips.....	6
Cooking Guide Table	7
Product Overview	8-9
Operating Instructions	10-12
Cleaning & Maintenance.....	13
Troubleshooting Guide.....	14-15
Mains Plug Fuse Replacement.....	17
Disposal Information.....	17
Statesman Warranty/Guarantee Information.....	18

SAFETY INSTRUCTIONS

Please ensure you read all instructions and warnings in this user guide prior to first use.

Keep this user guide for future reference.

Please handle this product with care and check it regularly to ensure it is in good working order.

If the product, power supply cord or plug shows any signs of damage: stop using it immediately or do not use. Unplug product and contact a qualified technical engineer or service agent.

- This appliance can be used by children aged from 8 years and above if they have been given supervision or instruction concerning the use of the appliance in a safe way and understand the hazards involved
- Cleaning and user maintenance shall not be made by children
- Keep the appliance and its cord out of reach of children aged less than 8 years
- Children shall not play with the appliance
- This appliance can be used by persons with reduced physical, sensory or mental capabilities or lack of experience and knowledge if they have been given supervision or instruction concerning use of the appliance in a safe way and understand the hazards involved
- When operating, the air fryer basket and crisping rack will be hot. Do not touch. Use the handle on the air fryer to remove the basket with food
- Use oven mitts or clothes when handling the air basket as it will retain some residual heat. This will prevent potential burns
- This air fryer is intended for indoor household use. Do not use outdoor for any purpose
- The power cord to the air fryer should be plugged into and 200-240V AC electrical out only
- If this air fryer begins to malfunction during use, press the basket release button and pull active fryer basket out of the air fryer. Unplug the power cord and stop use immediately. Contact a qualified technical engineer or service agent.
- Only place the air fryer on a dry, flat, stable and heat resistant surface
- Do not place the air fryer on or near a hot gas or electrical burner or heated oven
- Be sure to use on a heat resistant and even surface. If you don't have a heat resistant surface, please use a heat proof mat. Keep the appliance at least 10cm away from the wall, furniture or other flammable objects
- Do not place anything on top of the appliance
- Do not immerse the power cord, plug or air fryer unit in water or any other liquids
- Do not allow the power cord to hang over the edge of a table, counter or touch any hot surfaces

- Only connect the appliance to an earthed wall socket. Always make sure that the plug is inserted into the wall socket properly. To disconnect, turn any control to “off”, then remove plug from wall outlet
- If the power cord is damaged stop use immediately and contact a qualified technical engineer or service agent
- Do not attempt to repair the air fryer yourself. Contact a qualified technical engineer
- Do not obstruct the air flow inlets and outlets. These are located on the back and top of the air fryer
- Do not use any third-party attachments and accessories with this air fryer. It may lead to malfunctions or injuries
- When using the crisping rack ensure it is properly inserted into the air fry basket before adding food and cooking
- Always use the handles on the air fry basket to pull out basket. Please remember to press the release button before pulling
- Allow the air fryer to cool before cleaning or removing air fry baskets or crisping racks
- Unplug the power cord of the air fryer before cleaning and when it is not in use
- Never operate or store the unit in direct sunlight
- This appliance is designed to be used at ambient temperatures between 5°C and 40°C
- Always put the ingredients in the basket, to prevent them from coming into contact with the heating elements.



WARNING: This air fryer is not intended to be operated by means of an external timer or separate remote control system



WARNING: Never move the air fryer unit when hot or when containing hot food



WARNING: The air fryer will not operate unless the active air fry basket is fully inserted into the main air fry unit



WARNING: This air fryer should not be used to boil water



WARNING: This air fryer should never be used to deep fat fry food



WARNING: Under filling or over filling the air basket may damage the air fryer and result in serious injuries



CAUTION: Hot oil can collect at the base of the basket. Use with caution when removing the cooked food to avoid splashes and burns



WARNING: After operating, the air fryer basket and crisping rack will retain some residual heat. Let cool before washing or handling



WARNING: This appliance is intended to be used in household and similar applications such as:

- Staff Kitchen areas in shops, offices and other working environments
- Farm houses
- By client in hotels, motels and other residential type environments
- Bed and breakfast type environment



WARNING: Extreme caution must be taken when handling any hot fryer basket or crisping rack. Careful when opening basket to avoid escaping steam from fryer and food

AIR FRYING TIPS

- Please check on the cooking of your food as our air fryer cooking technology will cook food quicker than that of convectional ovens
- Pat the food dry before cooking to encourage browning and to avoid excess smoke
- To ensure even cooking/browning, always open the active basket halfway through the cook time and check, turn or shake foods in the air fryer basket. Some recipes call to brush or spray oil halfway through cooking. Adjust the temperature or time if needed
- Frying small batches will require shorter cooking times and yield crispier results.
- To avoid excess smoke when cooking foods high in fat (e.g bacon, chicken wings or sausages), it may be necessary to empty the fat gathered in the air fryer basket between batches
- Create a more spaced out surface area to allow more air to pass through by cutting food into smaller pieces. This can yield crispier foods
- Press breading/coating onto food to help it adhere. Refrigerate breaded foods for at least 30 minutes before frying. This allows the coating to be slightly absorbed and ensures the coating sticks to foods when cooking
- To improve crispiness in meat, coat the meat lightly with cornflour or rice flour and spray with oil
- Arrange breaded coated foods in air fryer basket so that food is not touching to allow air flow on all surfaces
- Spray oils works best with this air fryer. The spray distributes the oil more evenly and less oil generally needed. However, canola, olive, avocado, coconut, grape seed, peanut or vegetable oil work well too
- When baking or using wetter foods it is best to use parchment paper to line the basket
- Place a baking tin or oven dish in the air fryer basket if you want to bake a cake or quiche or if you want to fry fragile foods
- For best results with fresh chips use King Edward, Maris Piper, Romano, Désirée, or Russet potatoes. Make sure they have been washed and dried. this will help create a crispier chip

Air frying Pre-Packaged Frozen Foods

- Depending on the type and amount of food being cooked, suggested cook times may differ. Always check food halfway through cooking time to determine the final cook time and temperature
- Once the time is up, ensure the food is fully cooked

COOKING GUIDE TABLE

In the table below, we have suggestions to help you to select the basic settings for some favorite foods. Note: Keep in mind that these settings are indications. As ingredients differ in origin, size, shape as well as brand, we cannot guarantee the best setting for your ingredients.

Note: Add around 3 minutes to the cooking time or pre heat the air fryer when you start cooking.

	Amount (g)	Time (min.)	Temperature (°C)	Remark
Potato & fries				
Frozen French fries	300-500	15-20	200	Shake during cooking
Fresh French fries	300-500	20-30	180	Shake during cooking
Potato gratin	300-600	20-30	200	Shake during cooking
Meat & Poultry				
Steak	100-500	10-20	200	Turn over during cooking
Pork chops	100-500	10-20	200	Turn over during cooking
Hamburger	100-500	10-15	180	
Chicken wings/ drumsticks	100-500	15-25	200	Turnover/shake during cooking
Chicken breast	100-500	15-20	200	Turn over during cooking
Snacks				
Spring rolls	100-500	8-15	200	Use oven-ready. Turn over during cooking
Frozen chicken nuggets	100-500	8-15	200	Use oven-ready. Turn over during cooking
Frozen fish fingers	100-500	6-15	200	Use oven-ready. Turn over during cooking
Vegetables	100-500	8-15	160	
Baking				
Cake	400	20-25	160	Use baking tin
Quiche	500	20-25	180	Use baking tin/oven dish
Muffins	400	15-20	160	Use baking tin
Sweet snacks	500	15-20	160	Use baking tin/oven dish

PRODUCT OVERVIEW

Air Fryer

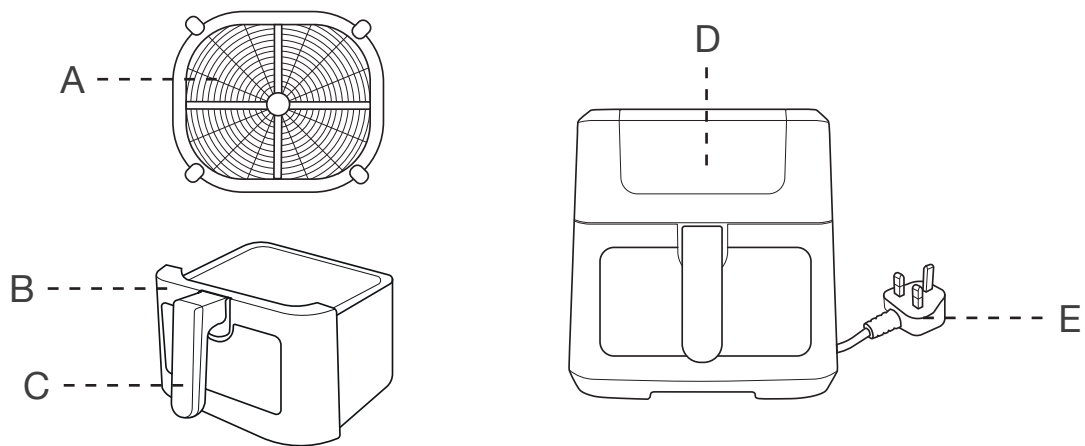

A. Crisping Rack
B. Fry Basket

C. Fry Basket Handle
D. Touch Control Panel

E. Power Cord/Plug

Air Fryer Inlets and Outlets

Air Flow Inlet

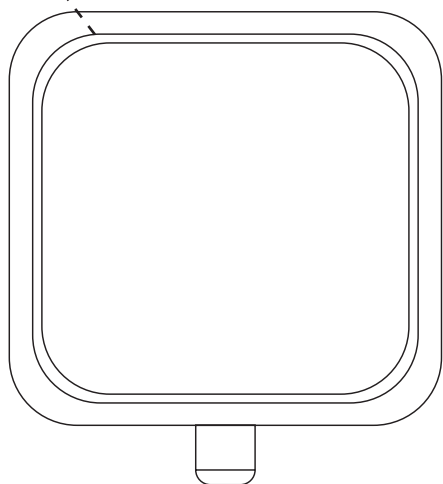

Air Flow Outlet
(caution hot air)

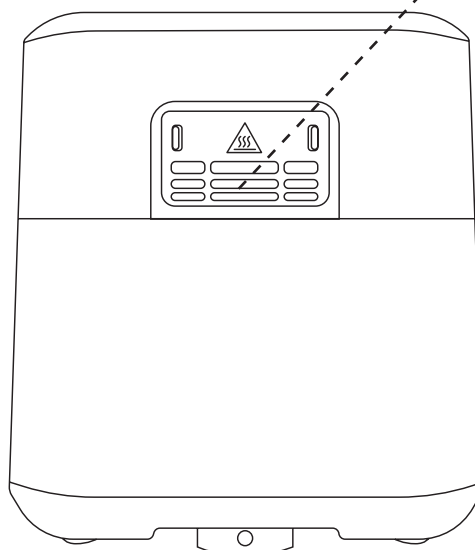



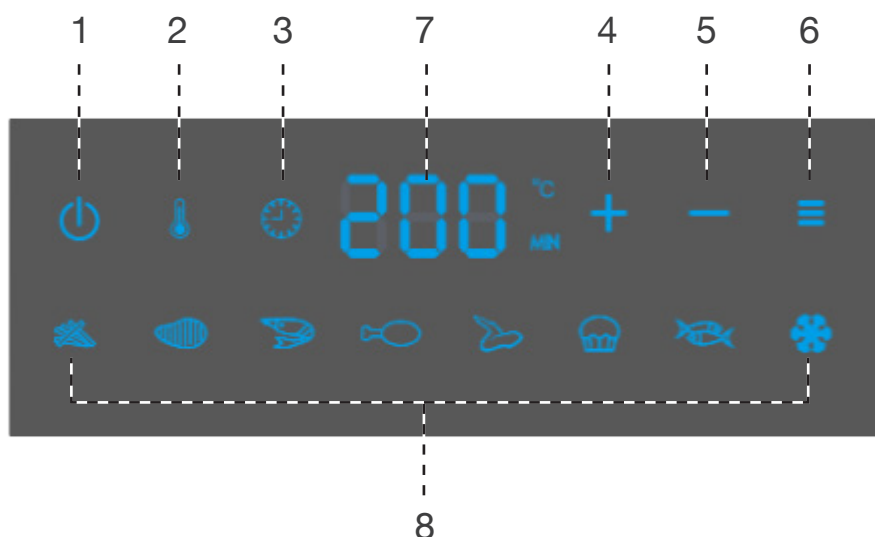





Touch Control Panel



1. On/Off/Start
2. Temperature setting
3. Cooking time setting
4. “+” increasing the cooking temperature or cooking time
5. “-“ decreasing the cooking temperature or cooking time
6. Menu button. Press this button to choose the correct functions from 8-15.
7. Digital display. Will show the cooking time and temperature alternately.
8. Preset functions

Preset Functions

-  **Air Fry - Fries** option see table on page 12
-  **Grill - Steak** option see table on page 12
-  **Air Fry - Shrimp** option see table on page 12
-  **Roast - Chicken** option see table on page 12
-  **Air Fry - Wings** option see table on page 12
-  **Bake - Cake** option see table on page 12
-  **Grill - Fish** option see table on page 12
-  **Defrost/ Keep Warm** option see table on page 12

OPERATION INSTRUCTIONS

Before First Use

Remove all packaging and labels from the inside and outside of the air fryer. Air fryer comes with a crisping rack which is located on top of poly packaging. Ensure you wash the rack and basket with hot soapy water. Wipe the air fryer main unit with a damp cloth.

DO NOT IMMERGE THE AIR FRYER MAIN UNIT IN WATER OR ANY LIQUIDS

1. Insert the crisping rack into the basket so that the rubber sides fit and lock in comfortably into the basket
PLEASE NOTE the rubber may be stiff the first few times of using and placing in
2. Insert the baskets into the main body
PLEASE NOTE ensure that basket is fully inserted otherwise air fryer will not operate



Note: During initial use, the air fryer may give off a slight odour. This is normal and should not affect your food.

Instruction For Use

This is an air fryer that works on hot air. Do not fill the fry basket with oil or frying fat.

- Put the plug in the wall socket.
- Carefully pull the fry basket out of the air fryer and ensure the crisping rack is inside.
- Add ingredients into the basket

Note: The air fryer can prepare a large range of foods. Refer to the food table (see p.5) for the right quantities and cooking time.

- Slide the fry basket back into the air fryer unit. **PLEASE NOTE** ensure that basket is fully inserted otherwise air fryer will not operate
- Press  On/off button to switch on the air fryer
- Press  Menu button to select the desired cooking mode. Keep pressing the mode button until the desired pre-set cooking programme icon flashes
- The default cooking temperature will be displayed, to alter press (+ / -) to increase or decrease. Once the selected temperature is displayed on the control panel it will flash for 5 seconds then change to time.

Note: if you want to return to change the temperature press the  temperature button

- The default cooking time will be shown, to alter press (+ / -) to increase or decrease.

Note: if you want to return to change the time press the  time button

- Press  On/Off/Start button to start cooking. The display will show the remaining cooking time.

Note: Add 3 minutes to the preparation time when the appliance is cold. If you want, you can also let the appliance preheat without any ingredients inside. In that case, choose the 1st Pre set function  and set the time in 3 mins and start.

- Some ingredients require shaking halfway through the cooking time. To shake the ingredients, pull the pot out of the appliance by the handle and shake it. Then slide the pot back into the fryer. Remember to replace the basket back correctly.

Caution: Do not touch the basket during shaking as it's very hot only use the handle. Also excess oil from some ingredients could have collected on the bottom of the fry basket. Take care when shaking and don't shake too hard as oils could splash.









- When you hear the BEEP sound, the set cooking time has elapsed.
- Pull the fry basket out of the appliance and place it on a heat-resistant surface.
- Check if the ingredients are ready and cooked thoroughly. If the ingredients are not ready yet, simply put the basket back into the appliance and cook for a few extra minutes.

Note: After use, the fry basket, the rack, and the ingredients are hot. Steam may also escape, this is normal.

- Empty the contents of the fry basket into a bowl or onto a plate. **It's recommended that you use a pair of tongs to lift the ingredients out. This will avoid potential splashing of oil.**

COOKING MODES

The table below outlines the 8 pre-set cooking programmes available with this air fryer along with the cooking times and temperatures:

Function	Default cooking time	Default cooking temperature	Adjustable time range	Adjustable temperature range
 Air Fry - Fries	15 mins	200°C	65°C-200°C	1min-90mins
 Grill - Steak	25 mins	180°C	65°C-200°C	1min-90mins
 Air Fry - Shrimp	12 mins	160°C	65°C-200°C	1min-90mins
 Roast - Chicken	20 mins	185°C	65°C-200°C	1min-90mins
 Air Fry - Wings	15 mins	200°C	65°C-200°C	1min-90mins
 Bake - Cake	25 mins	160°C	65°C-200°C	1min-90mins
 Grill - Fish	15 mins	165°C	65°C-200°C	1min-90mins
 Defrost/Keep Warm	20 mins	60°C	30°C-80°C	1min-90mins

Remember to set the time based on the weight and on the thickness of the food to cook or from its packaging instructions.

With Defrost function ensure the food is thawed all the way through but not started cooking.

Note: Defrost/keep warm function can also be used to DEHYDRATE. To Dehydrate you must keep resetting the timer as it will only go up to 90mins and dehydration can take 4-9 hours dependent on the food.

Note: You can also use the air fryer to reheat food. To reheat food, set the temperature to 150°C for up to 10 minutes. Check foods are reheated thoroughly.

CLEANING & MAINTENANCE

Clean air fryer after every use.

DO NOT CLEAN WHILST STILL HOT

Unplug unit from the electrical outlet and allow each part to cool down before starting any cleaning procedure. Remove container to make the unit cool down faster.

Do not place air fryer in water. Try to prevent splashes of water or other liquids from reaching the unit.

Do not use any abrasive or harsh chemicals.

- Wipe the outside of the appliance with a damp cloth
- Wash air fryer basket and crisping rack in hot soapy water or you can add to dishwasher. If cleaning in dishwasher do not put on higher setting than 50° and on top rack
- Clean the heating element with a cleaning brush to remove any food residues
- Clean the inside of the appliance with hot water and non-abrasive sponge. Basket and rack can be washed as normal non-stick pans, but we suggest to use a low dishwasher setting

Do not use metal kitchen utensils, abrasive sponges or abrasive cleaning materials to clean them, as this may damage the non-stick coating.

Storage

- Ensure air fryer is unplugged and all parts are clean and dry
- Do not store if still hot or wet
- Insert clean and dry crisping rack into basket and insert fully in to air fryer main unit correctly before storing
- Try to store covered and in dry cool place. Recommend in its original box

If your air fryer is not working contact a qualified technical engineer or service agent.

TROUBLESHOOTING GUIDE

If you are having problems with your appliance, please use our troubleshooting guide below. If you are unable to resolve the issue using this guide, please ring our Customer Service Department on 0844 848 5861. Please have the model code and purchase information available.

Problem	Possible Cause	Possible Solution
The air fryer does not work	The appliance is not plugged in.	Put the mains plug in an earthed wall socket.
	You have not pressed START.	Press the START button after selecting the menu, to start cooking.
	Check the basket is fully inserted to the main air fry unit	
	Several appliances are connected to one socket.	Try a different socket and check the fuses. The air fryer has a power of 1500W.
The outside of the appliance becomes warm during use.	The outside of the appliance becomes hot because the heat inside radiates to the outside walls.	This is normal. However, the handles and panel that you need to touch during use will still stay cool enough to touch.
Food is undercooked.	The amount of ingredients in the fry basket is too big.	Put smaller batches of ingredients in the fry basket. Smaller batches are fried more evenly and quickly.
	The set temperature is too low.	Check cooking temperature and increase accordingly
	Cooking time is too short.	Check cooking time and increase the cooking time accordingly.
Food is cooking unevenly.	Certain types of foods need to be shaken.	Shake halfway through the cooking time.

Air fried foods are not crispy when they are finished cooking	Check type of food as it may only be prepared in a traditional deep fryer.	Otherwise see air fry tips
I cannot slide the basket into the appliance properly.	There is too much food in the basket.	Do not fill the pot beyond 2/3 of its capacity.
White smoke comes out of the appliance.	You are preparing greasy ingredients.	When you fry greasy ingredients in the air fryer, a large amount of oil will leak into the basket. These oils may produce white smoke and the fry basket may heat up more than usual. This does not effect the appliance or the end result. Be careful when opening basket and smoke escapes.
	The fry basket still contains grease residues from previous use.	Smoke is caused by grease heating up in the basket. Make sure you clean the pan properly after each use.
Fresh chips are fried unevenly or not crispy in the air fryer.	You did not use the right potato type.	See air fryer tips
	You did not rinse the potato sticks properly before you fried them.	See air fryer tips
	The crispiness of the fries depends on the amount of oil and water in the fries.	Make sure you dry the potato sticks properly before you add the oil.
Cut the potato sticks smaller for a crispier result.		
		Add slightly more oil for a crispier result.

MAINS PLUG FUSE REPLACEMENT

Fuse Replacement (Class I)

This appliance must be earthed. Remove the fuse cover with a small flat head screw driver. Take out the fuse and replace with a new fuse of the same Amp. Replace the fuse cover and push back into place.

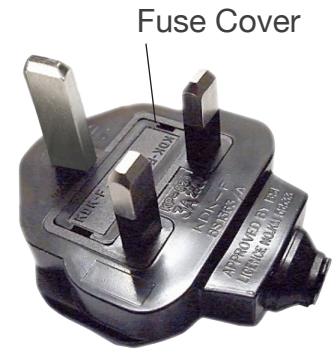

DISPOSAL OF OLD ELECTRICAL APPLIANCES

The European Directive 2002/96/EC on Waste Electrical and Electronic Equipment (WEEE), requires that old household electrical appliances must not be disposed of in normal unsorted municipal waste. Old appliances must be collected separately in order to optimise the recovery and recycling of the materials they contain and reduce the impact on human health and the environment. The crossed out "wheeled bin" symbol on the product reminds you of your obligation, that when you dispose of the appliance it must be separately collected. Consumers should contact their local authority or retailer for information concerning the correct disposal of their old appliance.

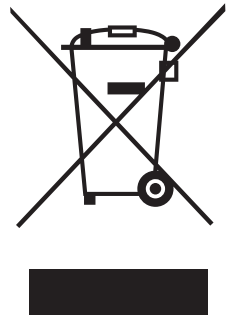

STATESMAN WARRANTY/GUARANTEE TERMS & CONDITIONS

THANK YOU FOR CHOOSING STATESMAN

As a valued customer we would like to offer you a **FREE 2-year warranty** to cover your product against any electrical or mechanical defects.

This means that in the unlikely event you develop a fault or problem with your product we will happily repair or replace the item free of charge.

To qualify for the guarantee, the product must be used for domestic household use only and in accordance with the instructions in the user manual. Any misuse of the product will result in the warranty being void.

The guarantee does not cover accidental damage, misuse, neglect, tampering or incorrect adjustment or installation.

The guarantee will be rendered invalid if the product is resold, has had its serial number or rating label removed (or has an invalid serial number or rating label), or if an unauthorised person has carried out any repairs or alterations.

The warranty does not cover accessories or consumable parts that require replacement under normal use. This includes shelving, dials, filters, belts and trays etc.

In the unlikely event of a breakdown please refer to the Troubleshooting Guide in your user manual and check all plugs, fuses and the electricity supply.

If you still require assistance, please contact our Customer Service Department on **01473 271 272** or write to us at the following address:

**Customer Service Department
38 Bluestem Road, Ransomes Industrial Estate, Ipswich, IP3 9RR**

Please quote the Product Code and the PO number on the rating label and give details of the exact fault. We will then decide whether to replace the item.

IMPORTANT NOTE: Before we arrange the replacement, you will be required to return a copy of your proof of purchase. Please retain your original.

If an item is replaced within the agreed warranty period, the warranty for the replacement item will be calculated from the purchase date of the original.

In the event that the product is inspected, and no fault is found, or the product is not within the guarantee period you will be charged for the repair and any carriage costs.

STATESMAN
kitchen appliances

**38 Bluestem Road, Ransomes Europark, Ipswich, IP3 9RR
EU: Castle Electrical Factors Ltd., Dundalk, A91 KA9R, IR**

0844 848 5861