

ASSEMBLY INSTRUCTIONS

L sofa

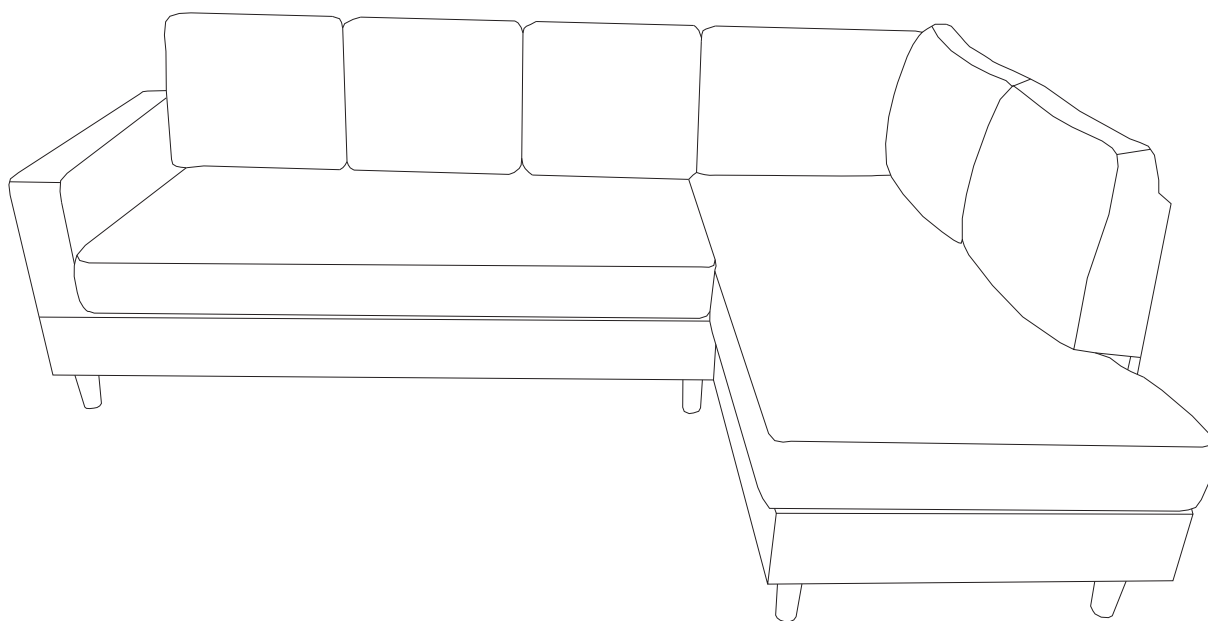

TIME



2 OF PEOPLE



DIFFICULTY

NOTICE

Instruction Booklet - Important Safety Information

Thank you for choosing our product. Please review this booklet carefully for essential safety information and keep it for future reference.

- Upon receiving the product, ***ensure all parts are present and intact*** before proceeding with installation. Follow the entire installation instructions provided.
- During installation, exercise caution and refrain from immediately tightening screws. Secure all screws to 80% before final tightening.

Returns are accepted only for items in their ***original, unopened condition***.



Before installation, please check that the parts are all included !

Carton

Materials

BOX A

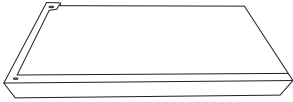

A*1



B*1

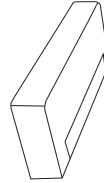

E*1

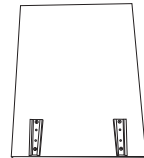

F*3

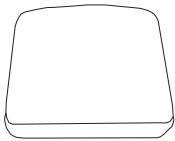

H*3



L*5



M*2



N*5



O*4

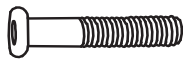

P*2



Q*2



R*1

Carton

Materials

BOX B

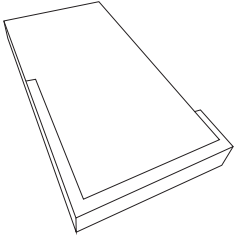

C*1

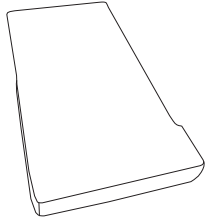

D*1

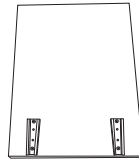

F*1

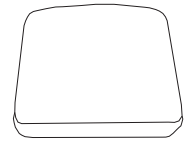

H*1

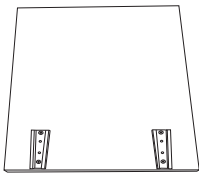

G*2

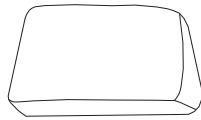

J*1

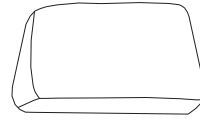

K*1



L*5



N*5



O*4

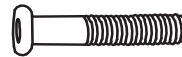

P*2



Q*2



R*1

Installation Steps

Materials

STEP1

Connect the seat frame A and the seat frame C together using screws.

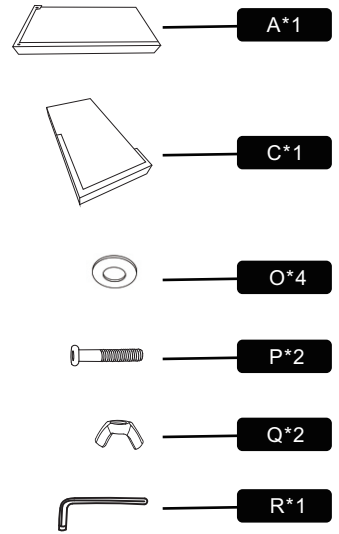
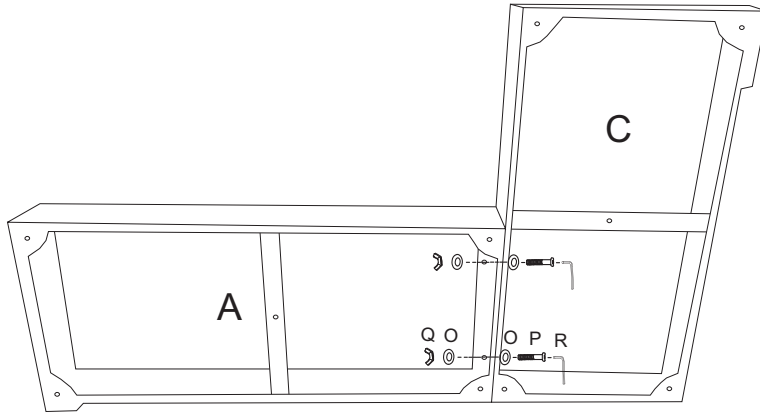

STEP2

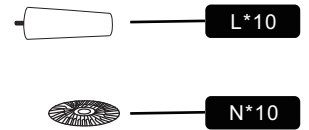
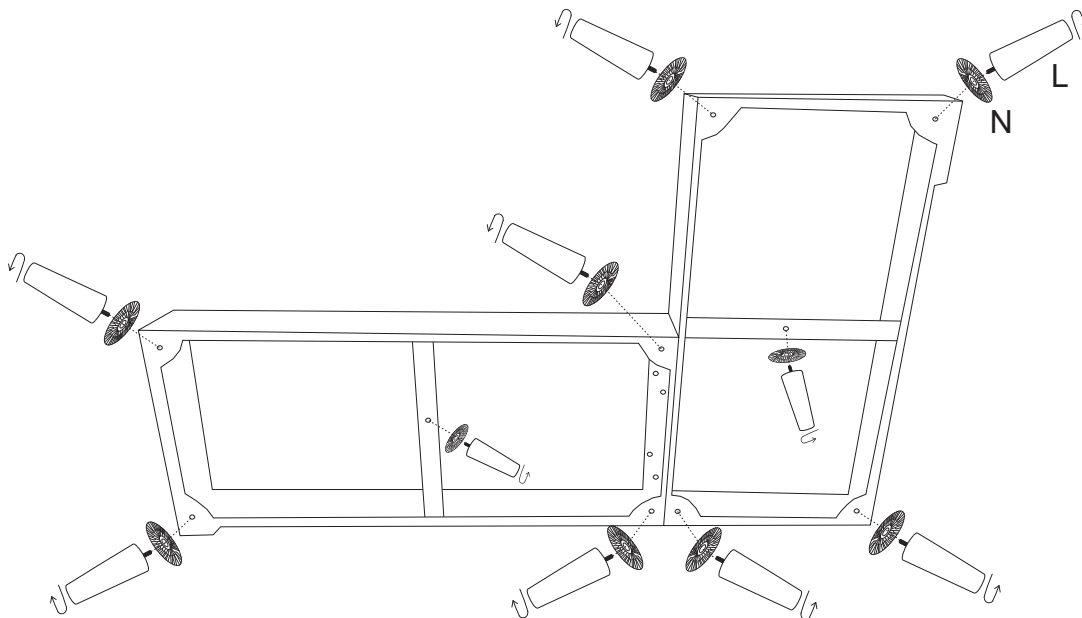

Align the sofa legs with the holes and rotate them to tighten the installation.

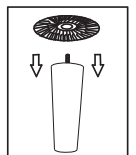

Installation Steps

Materials ▾

STEP3

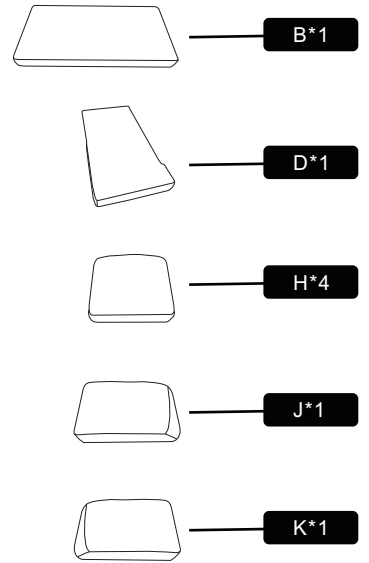
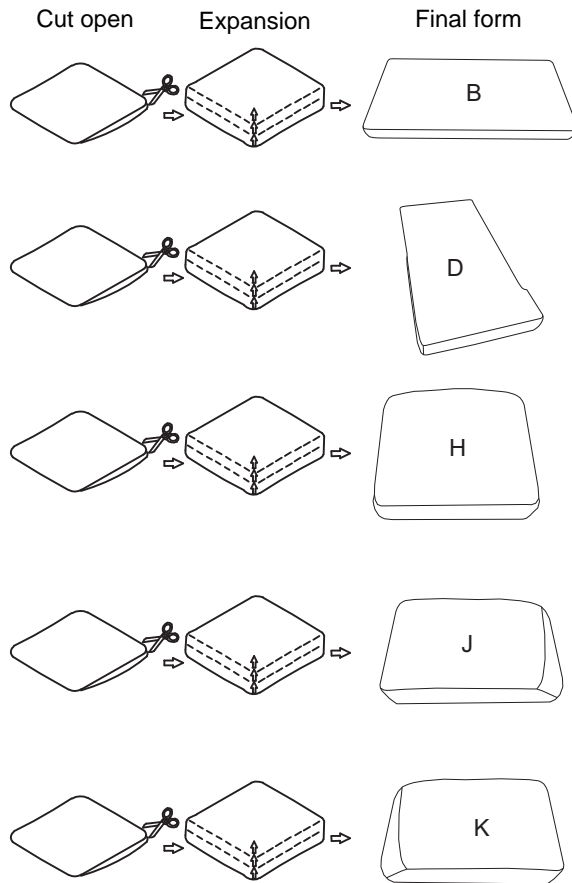

The cushions are compressed and require a recovery period after opening, with a maximum recovery time of 48 hours.

STEP4

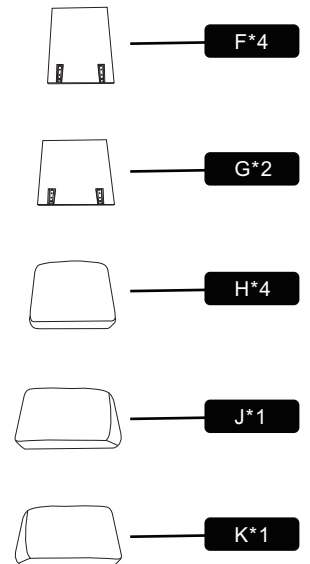
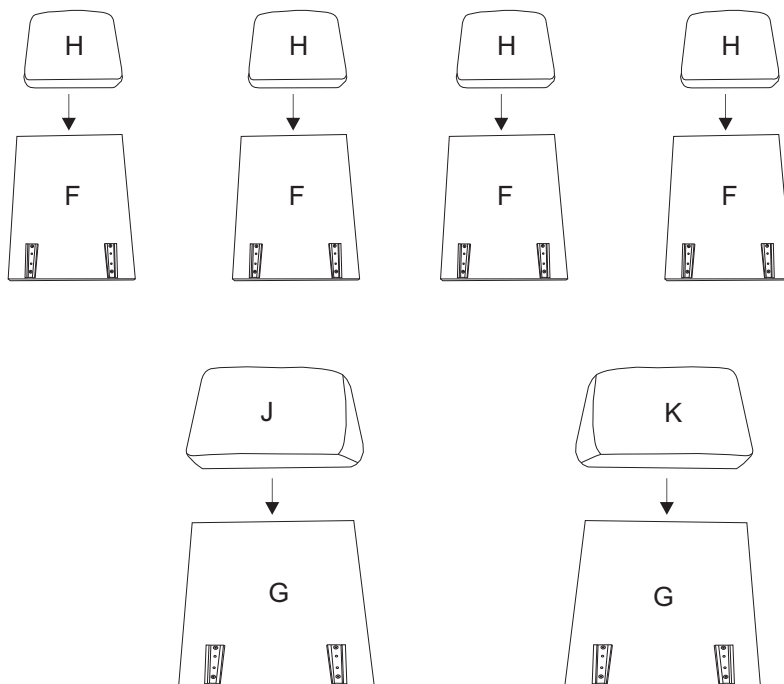

Put each cushion H , J , K over each backboard F&G.

Installation Steps

Materials ▾

STEP5

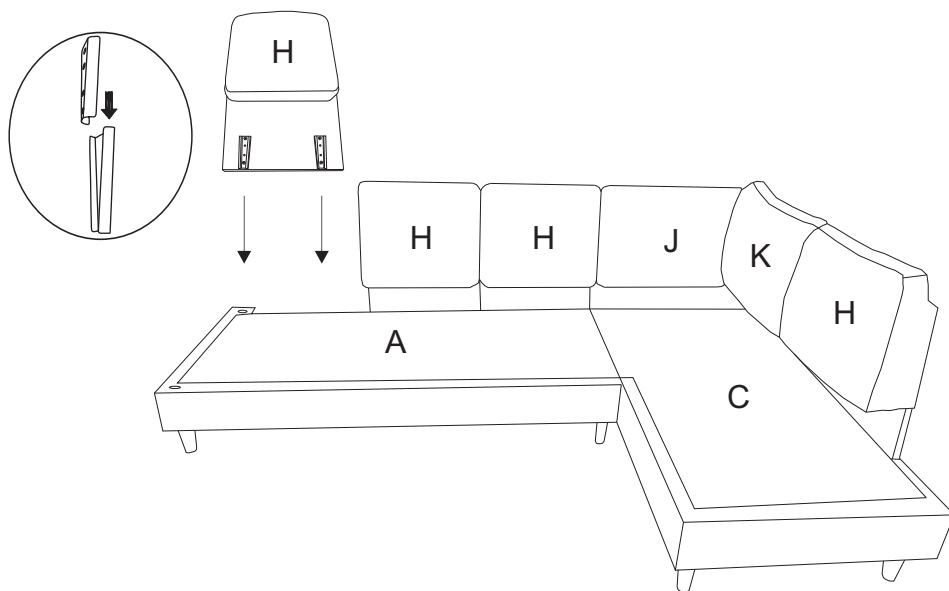

Connect the backrest board to the seat frame through the clips.

STEP6

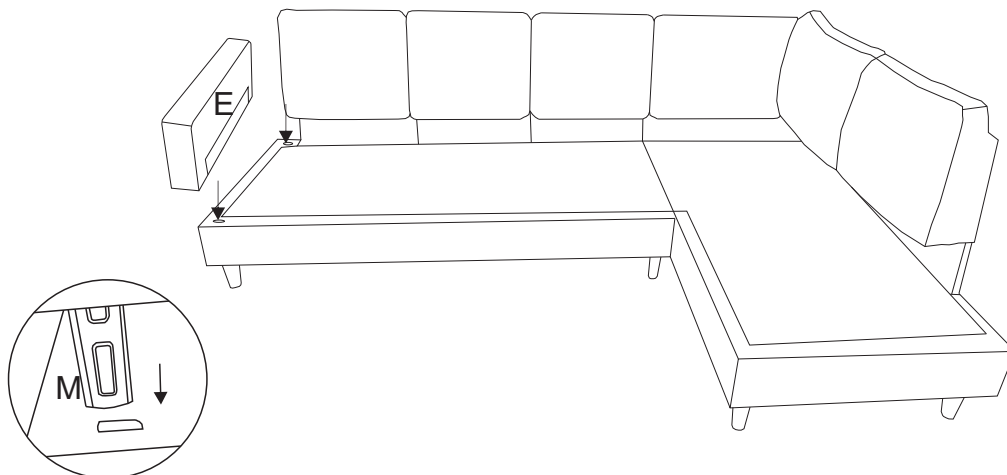
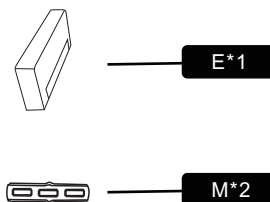

Install the armrest E according to the illustration.

Installation Steps

Materials ▾

STEP 7

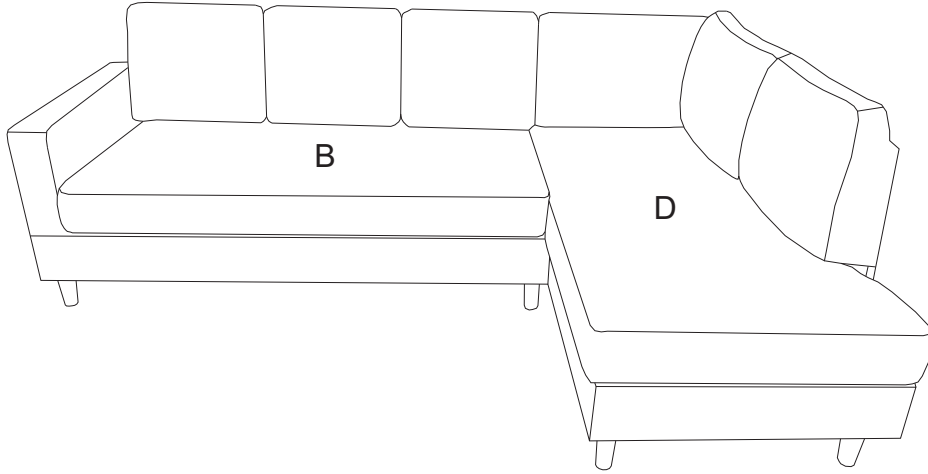

Place cushion B and cushion D.

COMPLETE

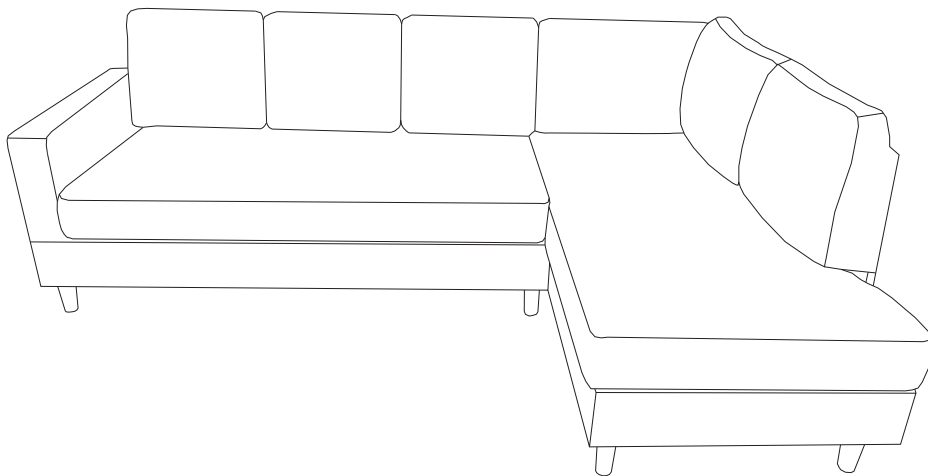

Frequently Asked Questions

We understand that receiving damaged or defective products can be disappointing, and we're here to assist you every step of the way. Here's how to address common concerns and initiate a damage claim:

1.What should I do if my shipment is damaged or products received are defective?

We're genuinely sorry to hear about any inconvenience caused. Please reach out to us promptly, and our team will prioritize resolving the matter swiftly and effectively, please retain the original box in case a return is required.

2.Can I return the product if I'm not satisfied?

While we uphold stringent quality standards and collaborate with experienced manufacturers, we acknowledge that dissatisfaction may arise. If you're still unsatisfied, of receiving the product. Simply message us with your reasons for return, and we'll facilitate the process.