

User Manual

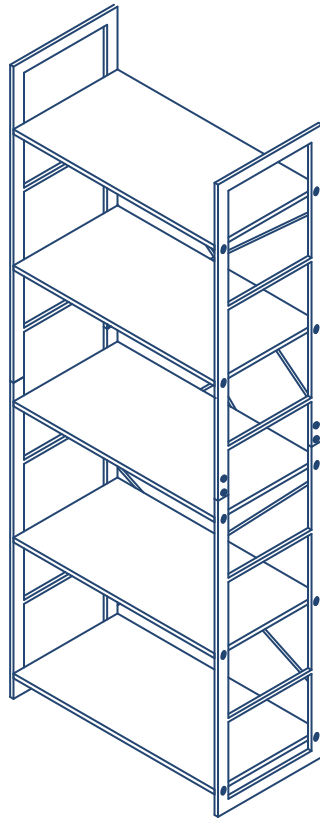

Thank you for choosing our product.

Before assembly, please read this USER MANUAL first, and check according to Parts List to make sure all parts are included.

Feel free to contact us if you have any concerns or questions about your product, we are always ready to help. Your satisfaction is our first priority!

Package Contents

BOOKCASE SHELF
STORAGE ORGANIZER

Assembly tool kit

Instruction manual

Precautions

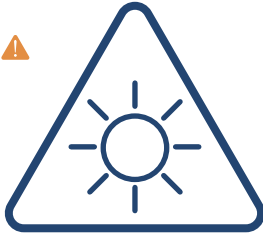

1. Avoid long-term direct sunlight exposure.



2. Keep away from heat.



3. Keep away from sharp objects.



4. Keep infants/children away from assembly parts to avoid choking and suffocation.



5. Max. Static Load Capacity per Shelf: 22lb(10kg)



6. Pay attention to avoid over-tightening fasteners, or they may induce cracking within the board.

Disassembly Diagram

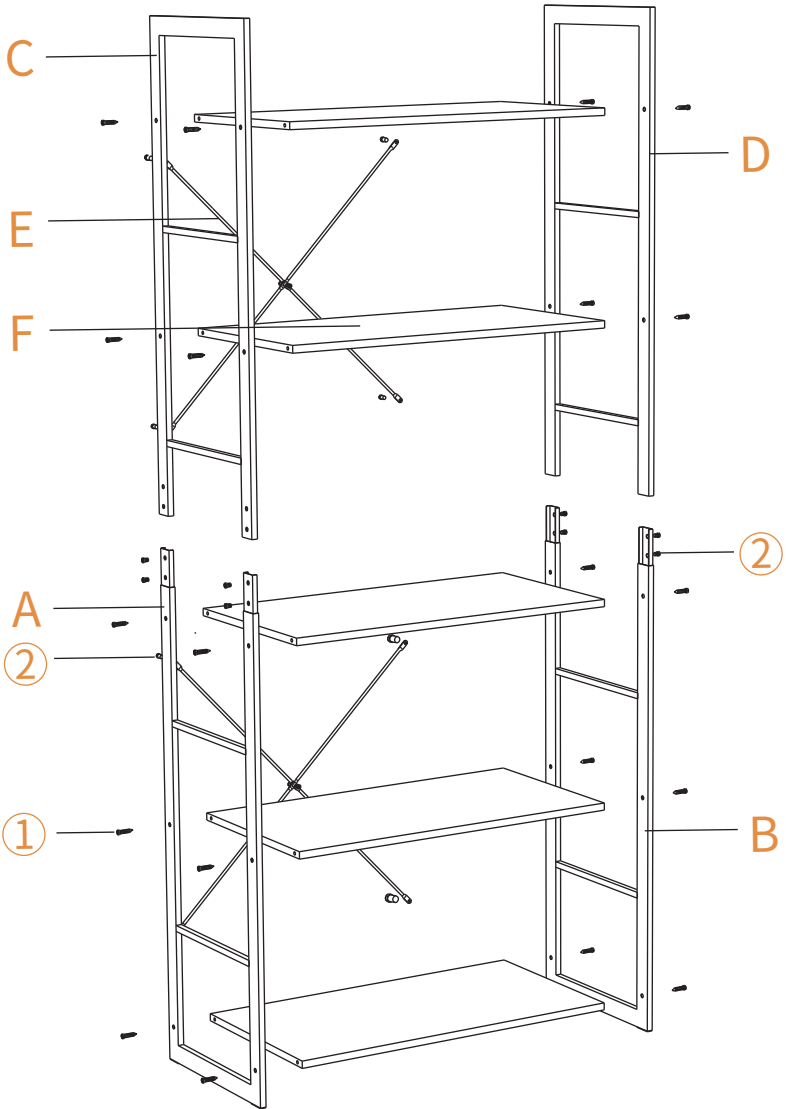

Parts List

For ease and safety, we recommend two people for assembly.

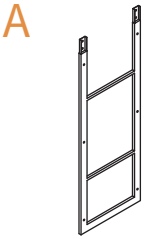

x1

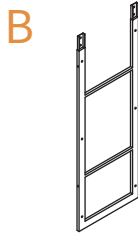

x1

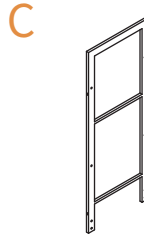

x1

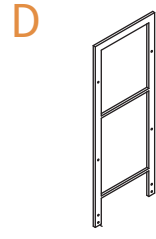

x1



x2

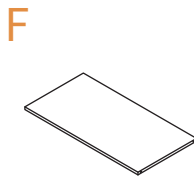

x5

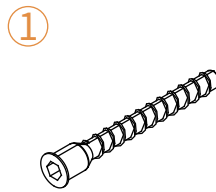

M6x40

x23(3 Spares)

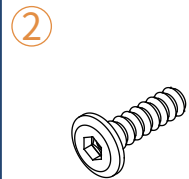

M6x10

x18(2 Spares)

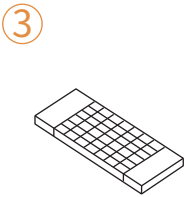

Rubber Pad

x4

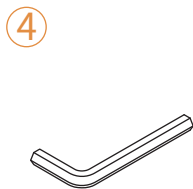



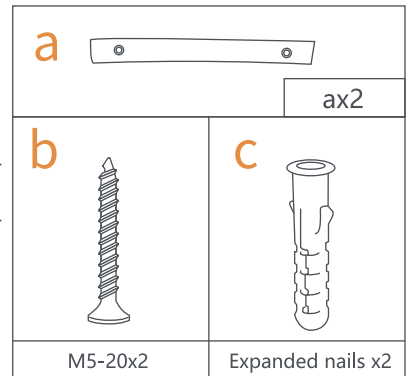
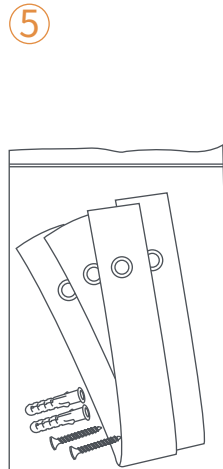



x2(1 Spare)



Assembly Instructions

1

Attention: Please make sure that A,B,C and D which side with holes are aligned in the same direction. Connect each of frame A,B,C and D just the way as the drawing indicated by tightening screws ②.

A x1		C x1	
B x1		② x8	
D x1		④ x1	

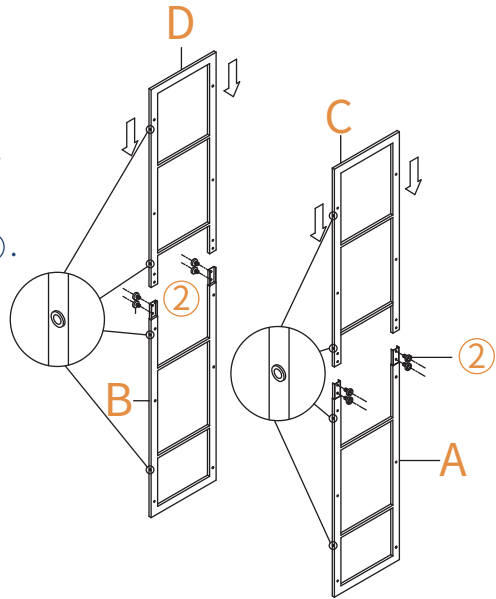





2

Install the five boards F*5 on the frames accordingly by tightening all screws ①.

Attention: Please make sure that A,B,C and D which side with holes outwards.

Rotate each screw just a few turns. When all M6x40 screws are threaded, go back and tighten all remaining screws. Finally, please make sure all the screws are 100% tightened.

F x5		① x20	
③ x4		④ x1	

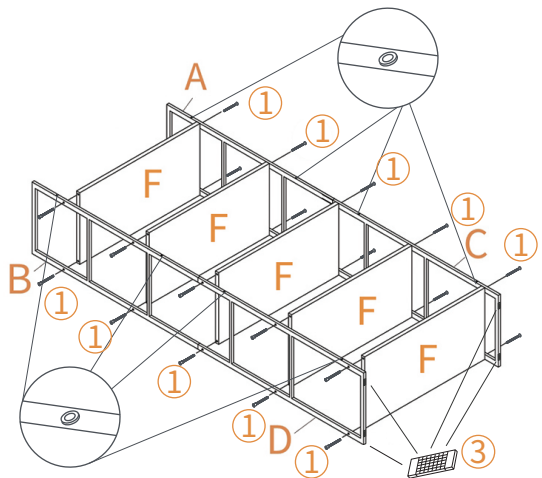

Paste the four pieces of rubber pad to the bottom of the bookshelf.

Assembly Instructions

- 3** Fix the crosses to the frames in the right position as indicated in the drawing by tightening all screws ②. Pay attention to the direction of the connected frames A,B,C and D with hole sides outwards.

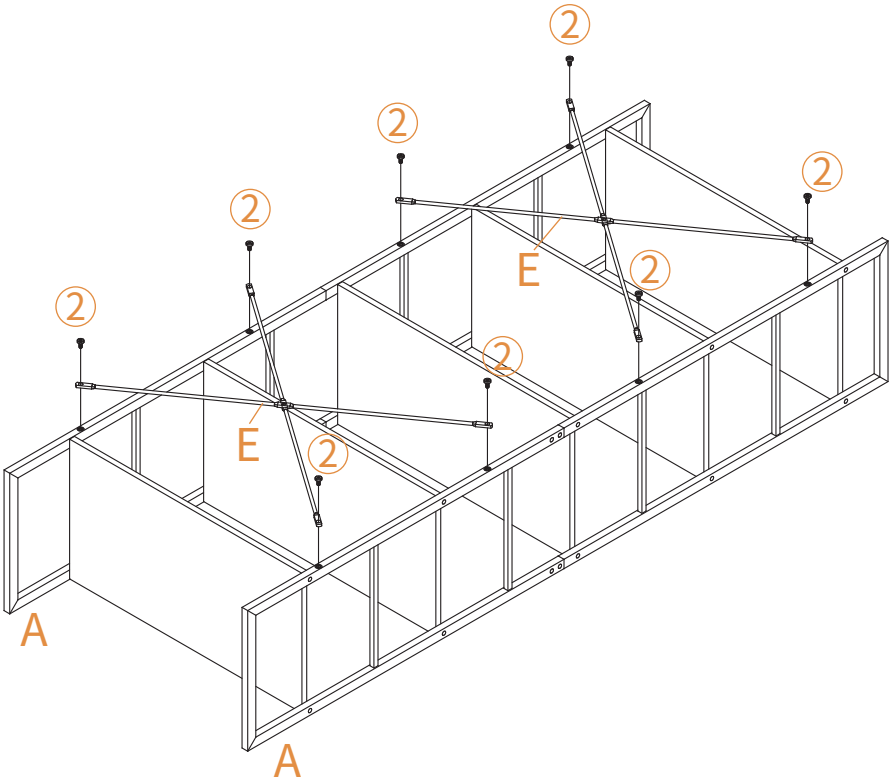

E x2		② x8		④ x1	
----------------	---	----------------	---	----------------	---

Please install anti-tip device as following steps if you need

- 4** Use a power drill to make a 6mm hole in the wall.
Use philips head screwdriver or stubby screwdriver, screw the plastic anchors into the holes until they are flush to the wall. Fix a,b,c together, insert 1 screw into the drywall anchor, tilt your philips head screwdriver, and then lock to the wall, but do not over tighten.

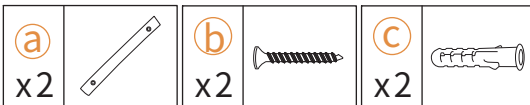
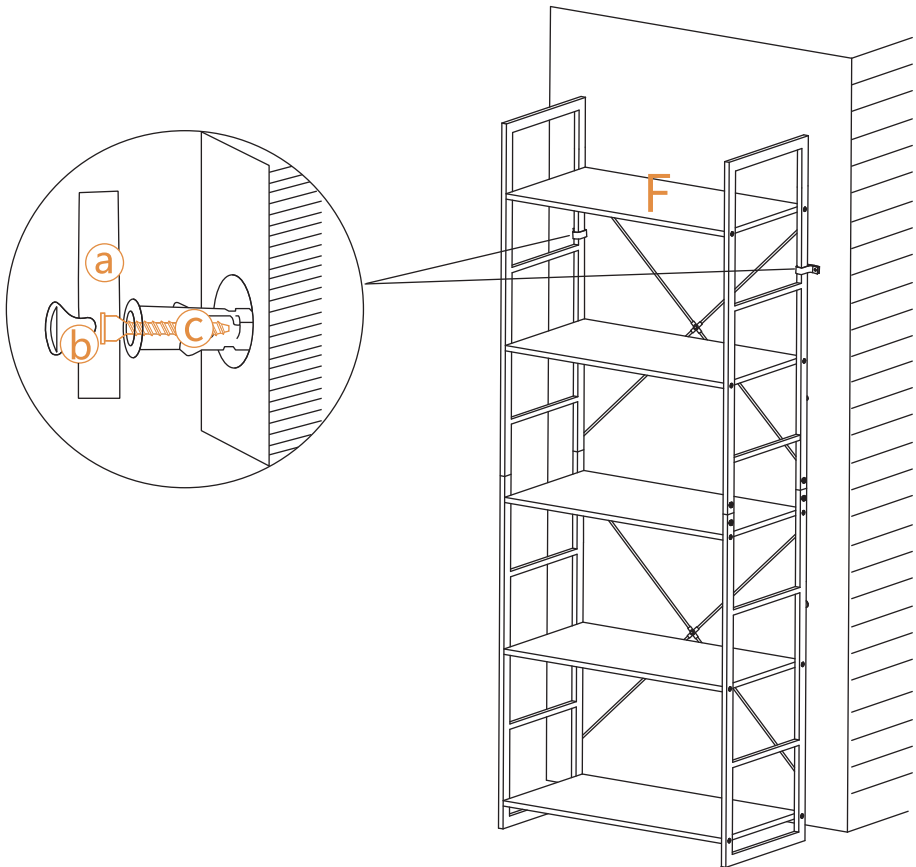

Customer Service



30-Day Return Policy

If you're not completely satisfied with your purchase, simply return the merchandise via our official customer support. Unused merchandise can be refunded or exchanged within 30 days from the original purchase date.



1-Year Warranty

We guarantee your product is free from defects in product material and workmanship for one (1) year starting from the date of purchase during normal use of household conditions. If your appliance fails to operate properly within our warranty period, we will arrange a new one. Replacement is free and all shipping costs are covered.

Problems You May Encounter

PART	PROBLEM	SOLUTION
Whole Product	Parts are missing, defective or with wrong parts in package.	You can contact us and we will get back to you within 24 hours. Or, you can reach us via after-sales email.
	Having issue(s) while reading the instruction or completing the assembly.	You can contact us and we will get back to you within 24 hours. Or, you can reach us via after-sales email.
	Encountering non-human caused damage during usage.	If the product is damaged due to non-human causes, please keep the product and send us photos of it. We will ascertain the cause of the product damage within 48 hours and provide you with a satisfactory solution.
Tabletop or Shelf	Board Surface is broken, scratched or lack of screw holes.	You can contact us and we will get back to you within 24 hours. Or, you can reach us via after-sales email.
	The screw holes on the board and on the steel frame are not aligned.	1. Please tighten the screws on the board by 70%, do not tighten completely. 2. Adjusting board and steel frame until the screw holes are aligned, then tighten all the screws.
	The board is uneven or has gaps after assembly.	1. Loosen the screws at the uneven or gap positions; adjust until the tabletop is flat and tight, and then tighten the screws. 2. If your problem still can't be solved, please feel free to contact us.
Steel Frame	The steel frame is bent, broken, painted, rusted or damaged.	You can contact us via Amazon, and we will get back to you within 24 hours. Or, you can reach us via after-sales email.
	The product is unstable after assembly.	1. Check if the screws are 100% tightened. 2. Read throughout the manual, check are there any parts installed incorrectly or missing assembled. 3. If your problem still can't be solved, please feel free to contact us.
	Encountering non-human caused damage during usage.	If the product is damaged due to non-human causes, please keep the product and send us photos of it. We will ascertain the cause of the product damage within 48 hours and provide you with a satisfactory solution.