

ASSEMBLY INSTRUCTIONS

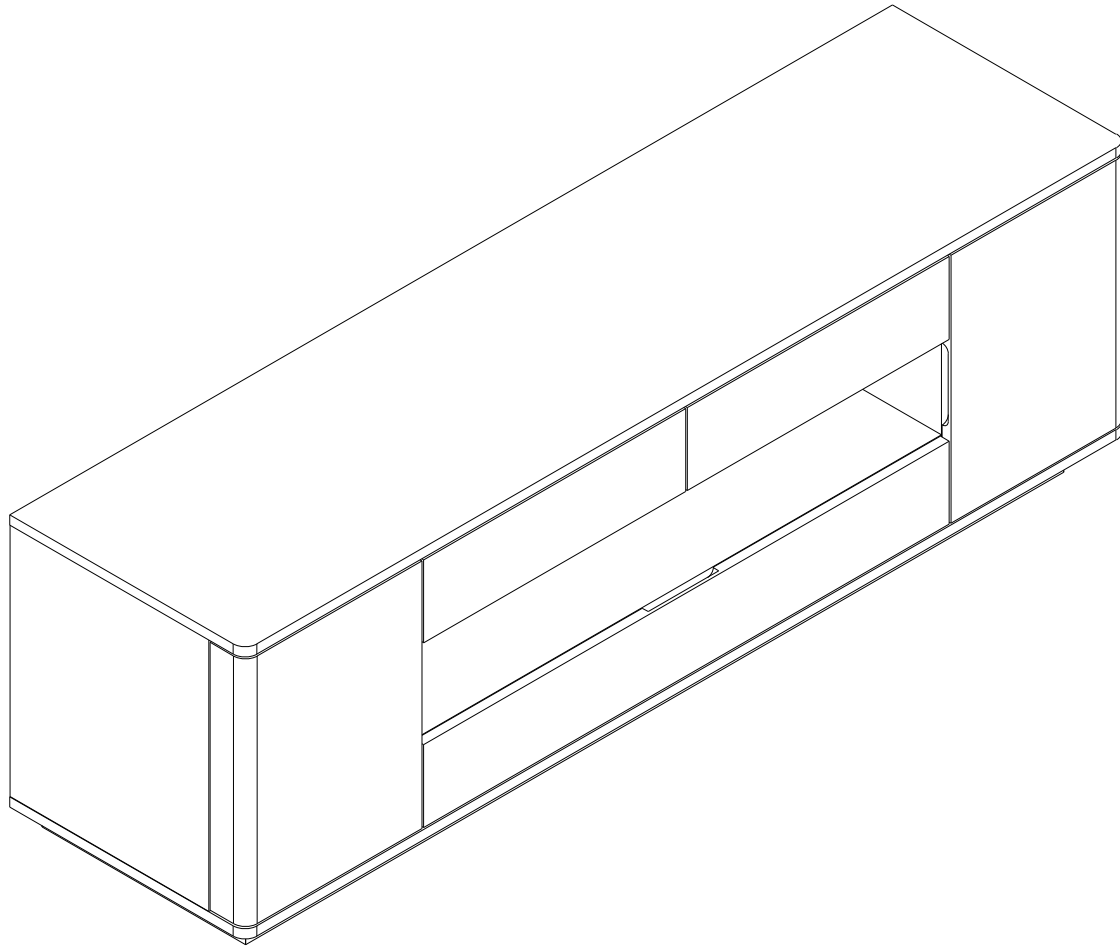

Notice:

1. Follow the installation instructions. Please confirm all accessories are preset before installation.
2. Do not fully tighten the screws during initial assembly. Fully tighten screws only once all pieces which are correctly assembled.
3. If you encounter any problems during installation, please contact our customer service.
4. Please unbox the item from the side with an open-label and put a carpet on the floor to avoid scratching it.

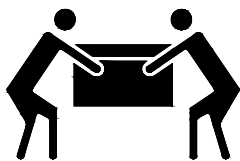

Recommended installers:2

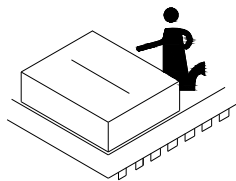

Put a carpet on the floor
before unpacking

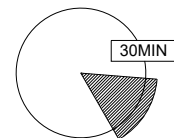

Estimate installation time:
30minutes



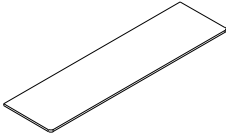
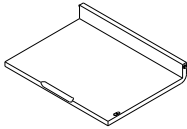
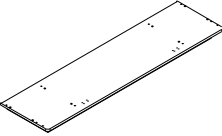
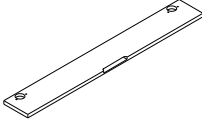
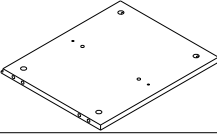
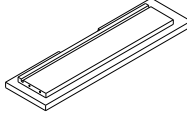
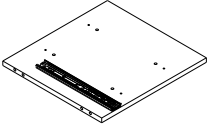
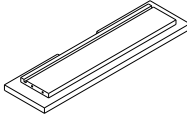
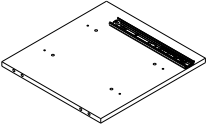
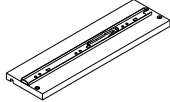
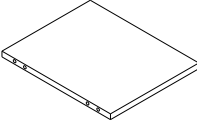
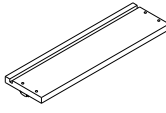
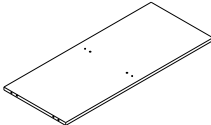
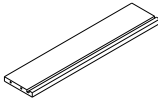
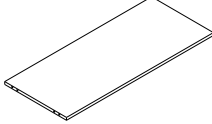
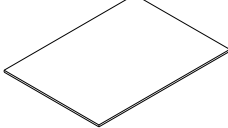
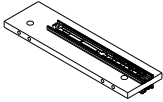
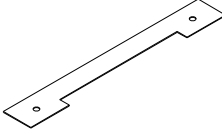
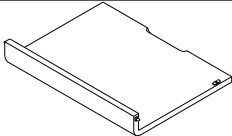
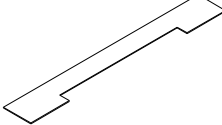

ASSEMBLY INSTRUCTIONS

PART LIST

Item no.	Reference Image	Qty	Item no.	Reference Image	Qty
(A)		X1	(K)		X1
(B)		X1	(L)		X1
(C)		X2	(M)		X1
(D)		X1	(N)		X1
(E)		X1	(O)		X2
(F)		X2	(P)		X2
(G)		X1	(Q)		X2
(H)		X1	(R)		X2
(I)		X1	(S)		X1
(J)		X1	(T)		X1

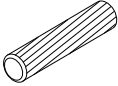
ASSEMBLY INSTRUCTIONS

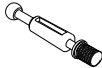
HARDWARE LIST

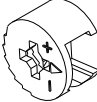
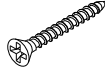
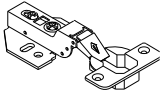
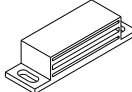
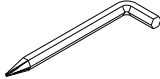
Item no.	Reference Image	Qty	Item no.	Reference Image	Qty
1	 Ø8*30mm	X36+3	5	 Ø3.5*12mm	X12+1
2		X34+3	6	 Ø3*15mm	X34+3
3		X34+3	7	 Ø3.5*30mm	X18+1
4		X2	8		X2
			9		X1

ASSEMBLY INSTRUCTIONS

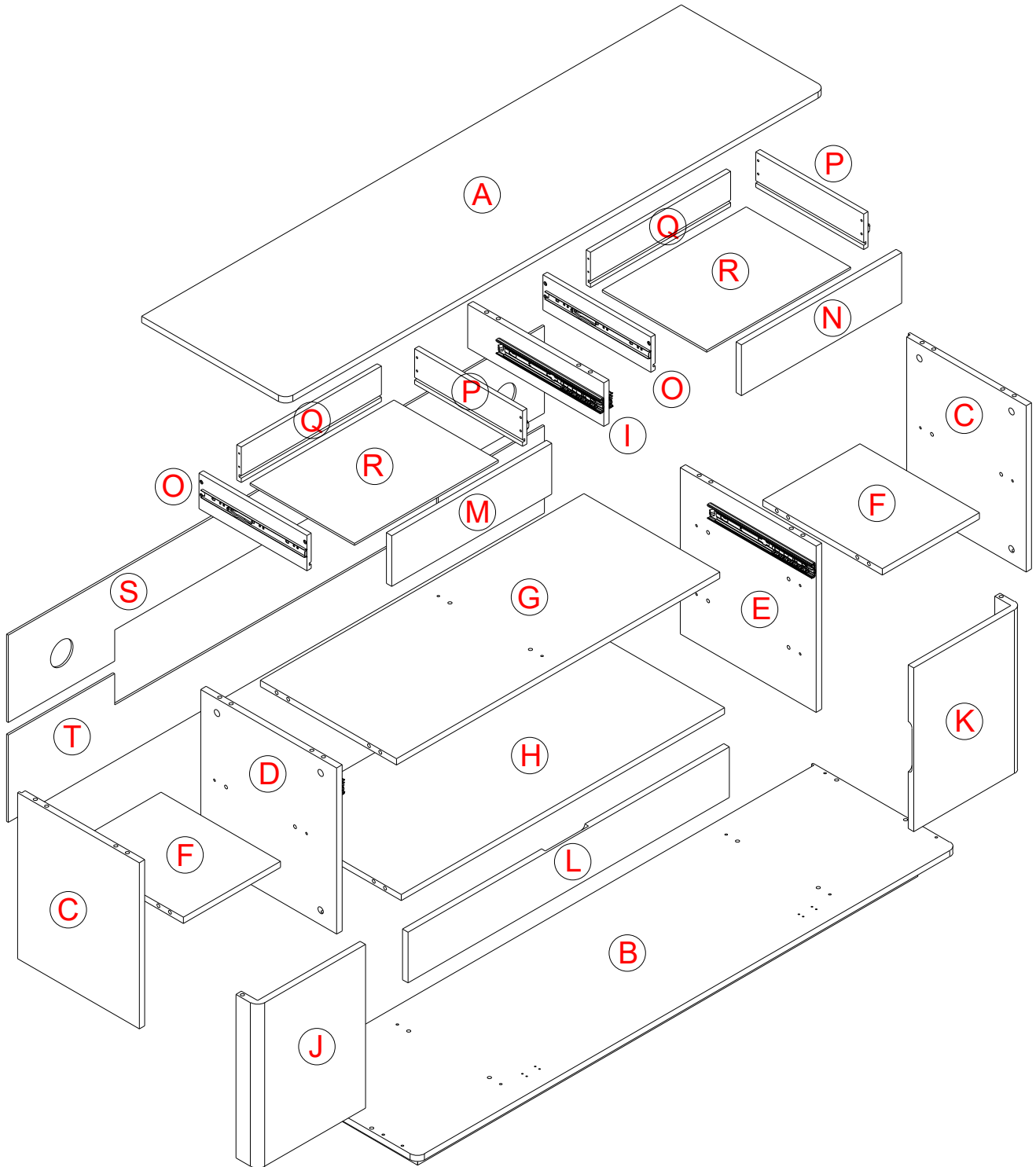

ASSEMBLY INSTRUCTIONS

1

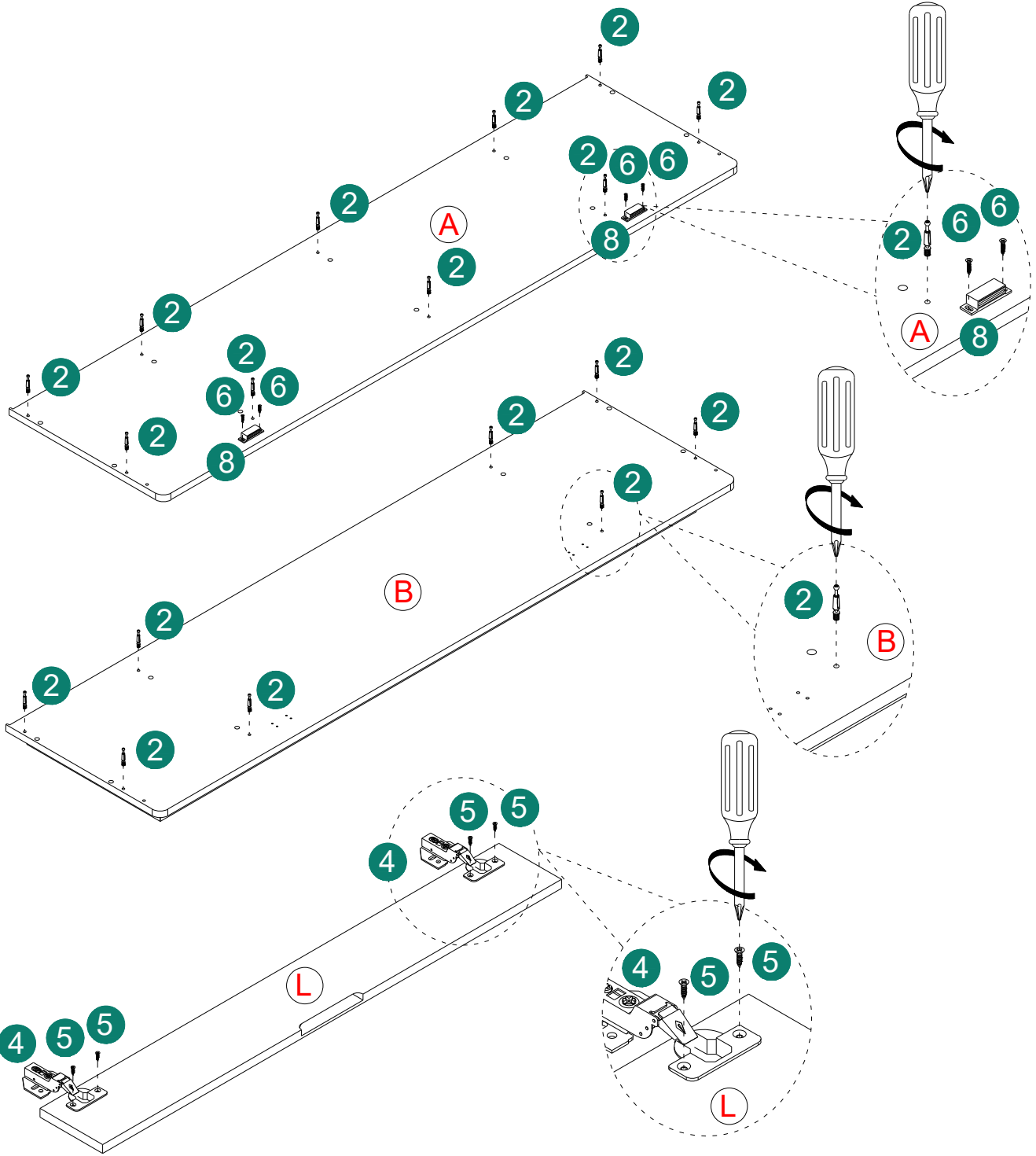
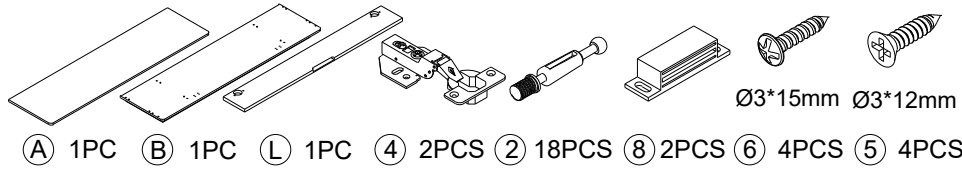

ASSEMBLY INSTRUCTIONS

2

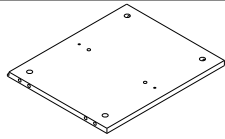

Ⓒ 2PC



Ø3*12mm
Ⓔ 8PCS



Ⓐ 4PCS

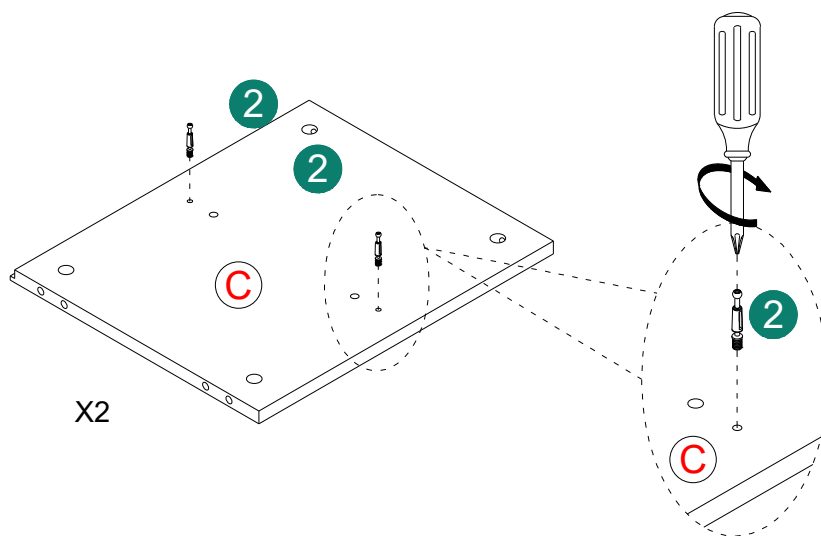
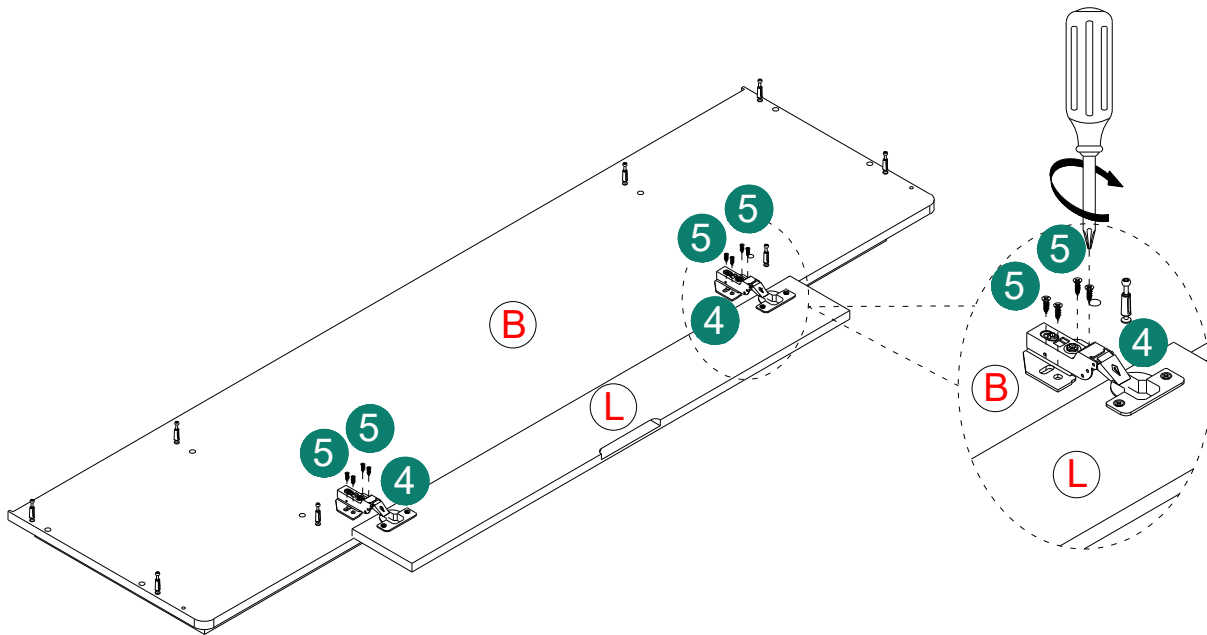

X2

ASSEMBLY INSTRUCTIONS

3

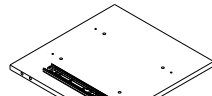

D 1PC

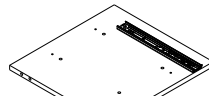

E 1PC



2 12PCS

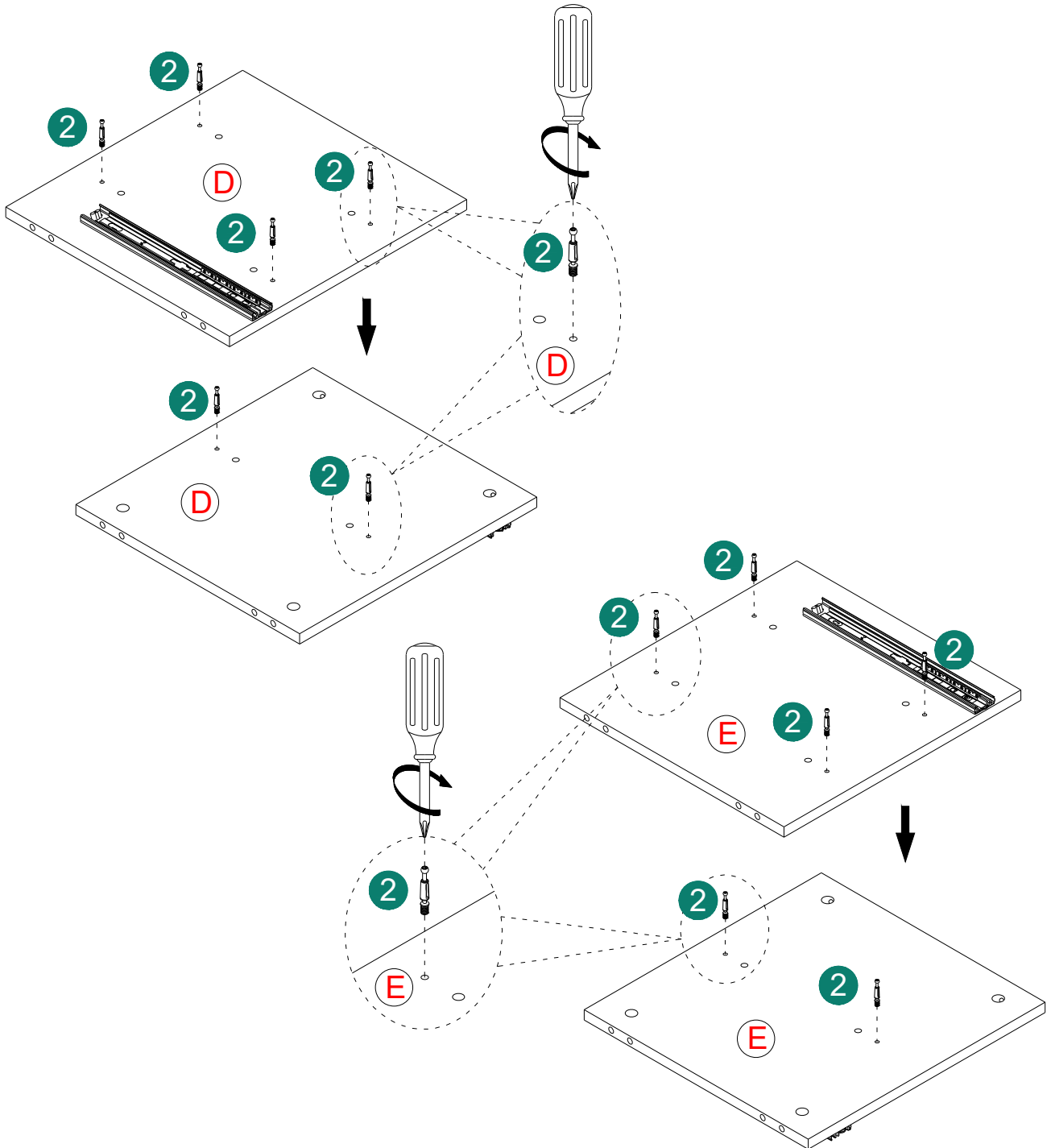

ASSEMBLY INSTRUCTIONS

5

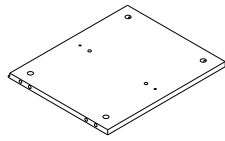

Ⓒ 2PC

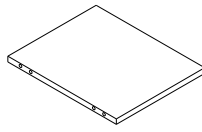

Ⓕ 2PC



Ⓓ 8PCS

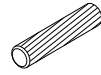

Ⓖ 8PCS

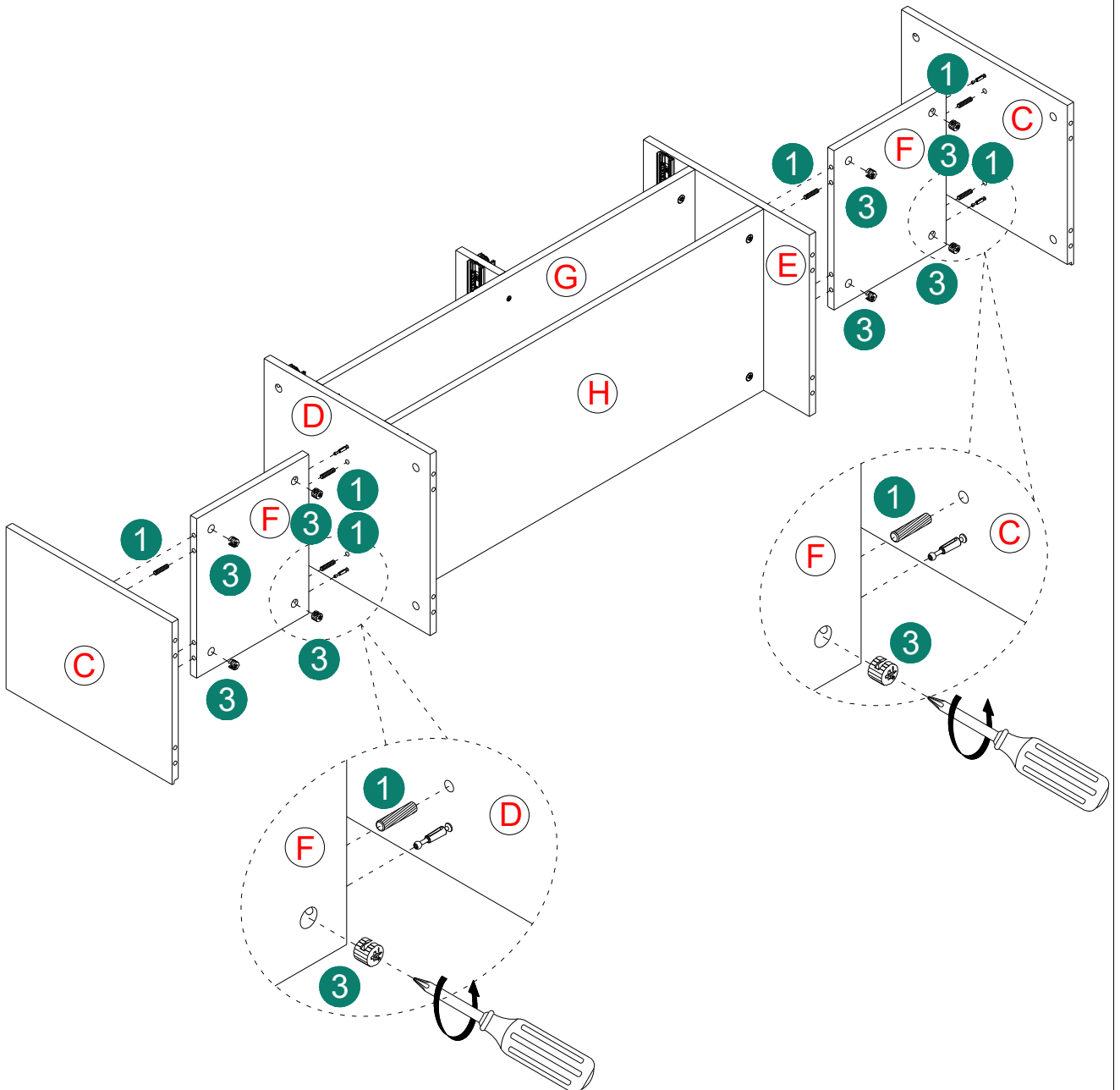

ASSEMBLY INSTRUCTIONS

6

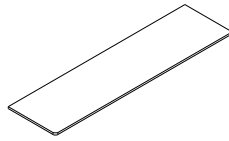

③ 10PCS

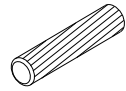

① 10PCS

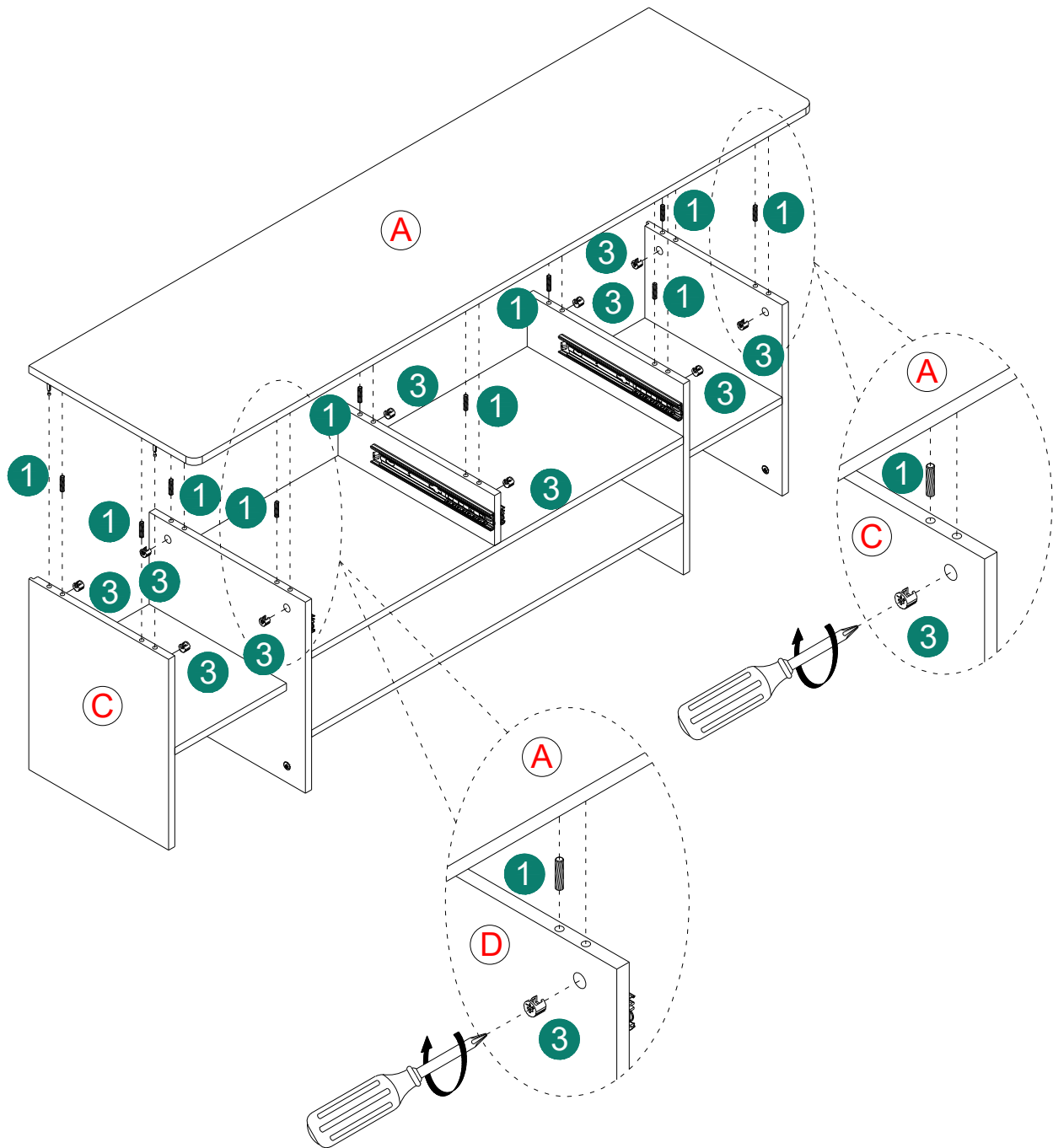

ASSEMBLY INSTRUCTIONS

8

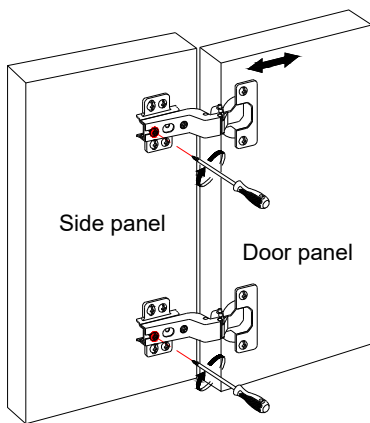

1

Front-to-Back Direction Adjustment:

Rotate the screws on the door hinges shown in the image. The door panel can be moved front-back.

Adjustment range: 4mm

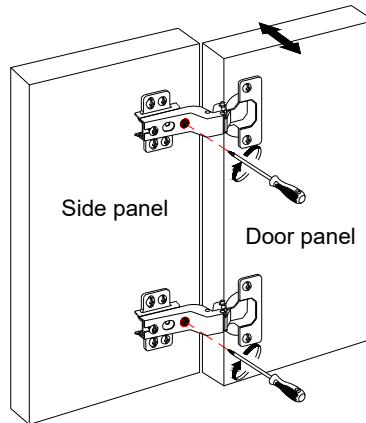

2

Left-Right Direction Adjustment:

Rotate the screws on the door hinges shown in the image. The door panel can be moved left-right.

Adjustment range: 3mm

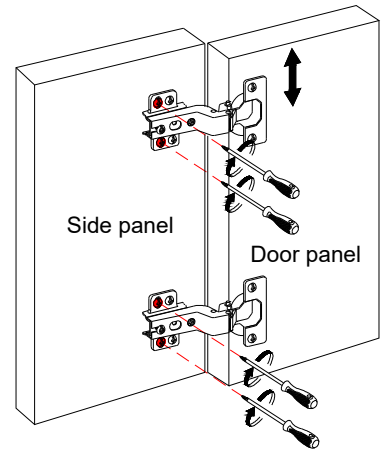

3

Up-Down Direction Adjustment:

Rotate the screws on the door hinges shown in the image. The door panel can be moved up-down.

Adjustment range: 4mm

ASSEMBLY INSTRUCTIONS

9

Common Door Panel Issues:

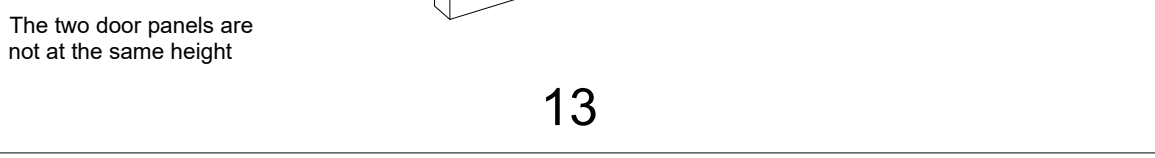
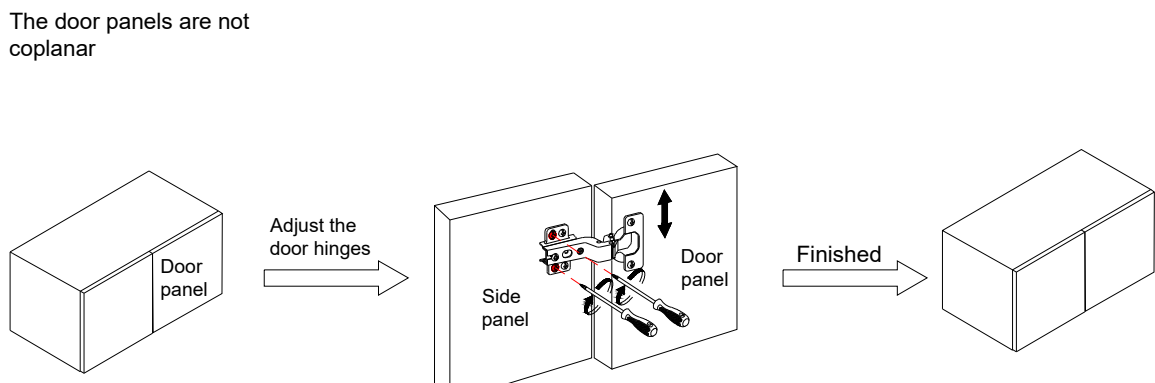
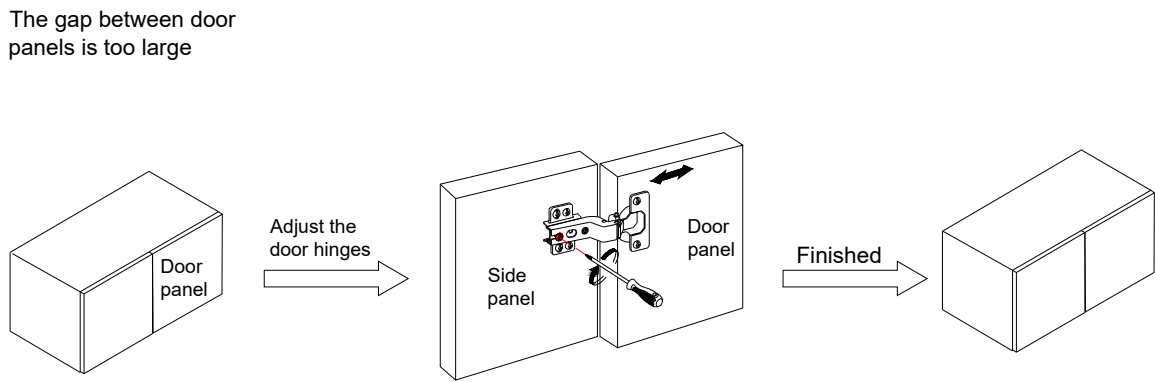
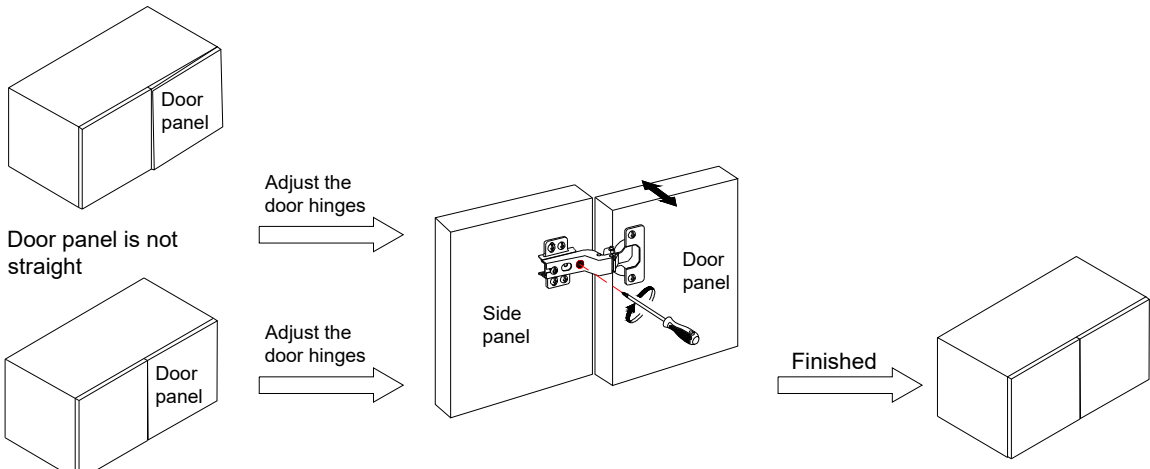

ASSEMBLY INSTRUCTIONS

10

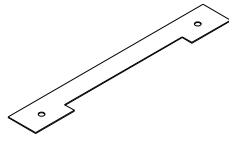

Ⓢ 1PC

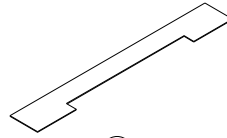

Ⓣ 1PC



Ø3*15mm

ⓐ 30PCS

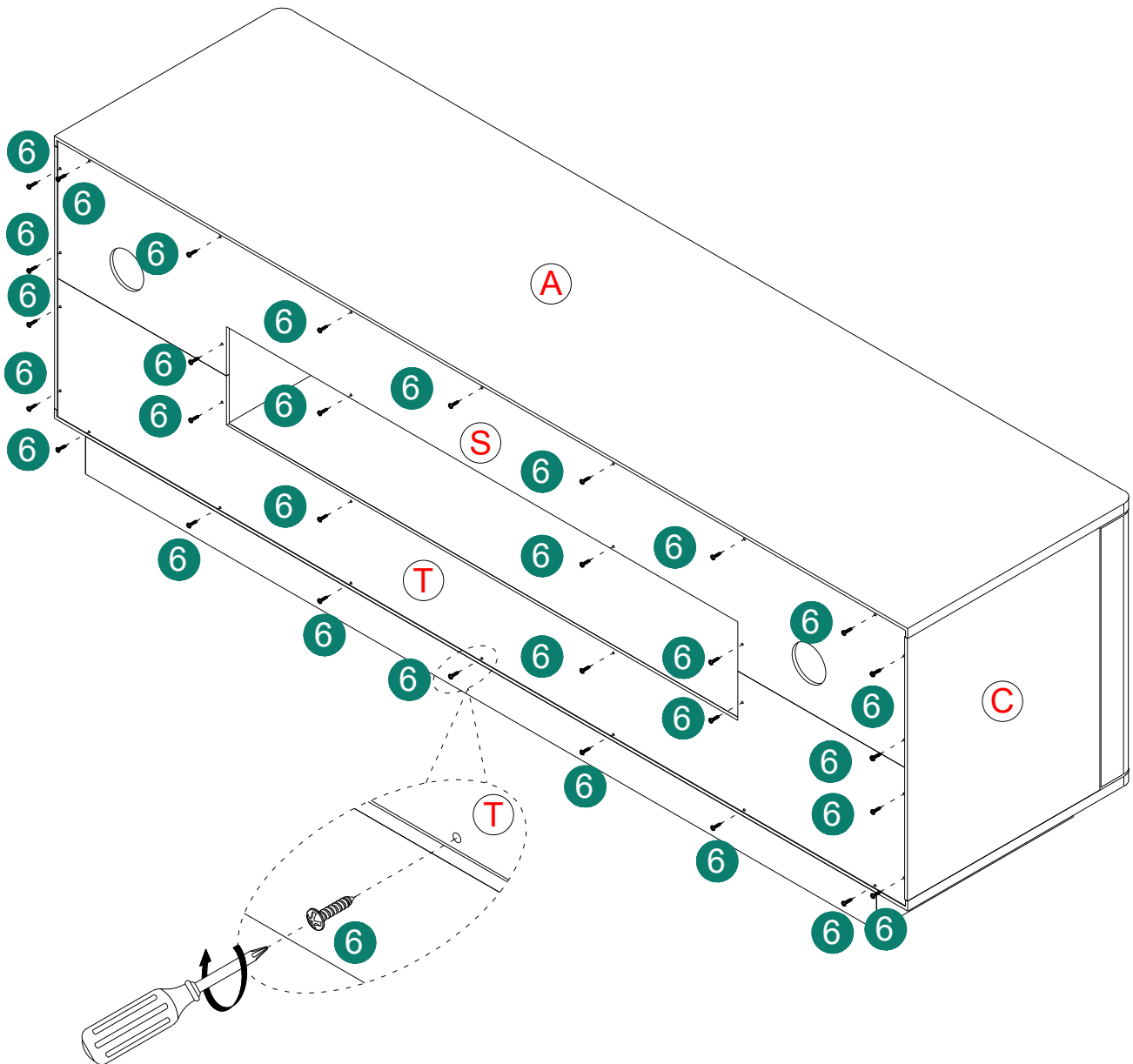

ASSEMBLY INSTRUCTIONS

11

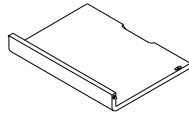

ⓐ 1PC

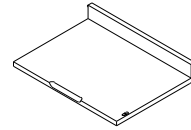

ⓑ 1PC

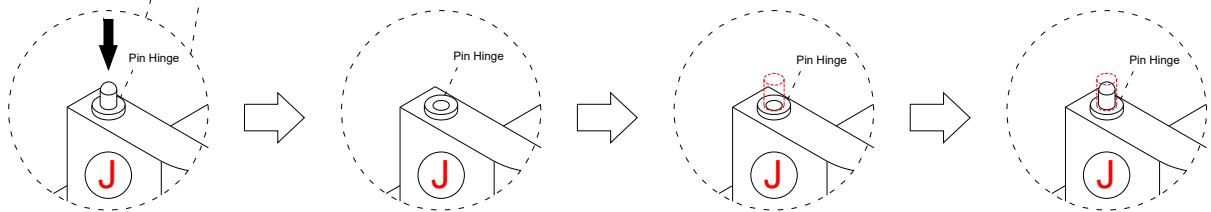
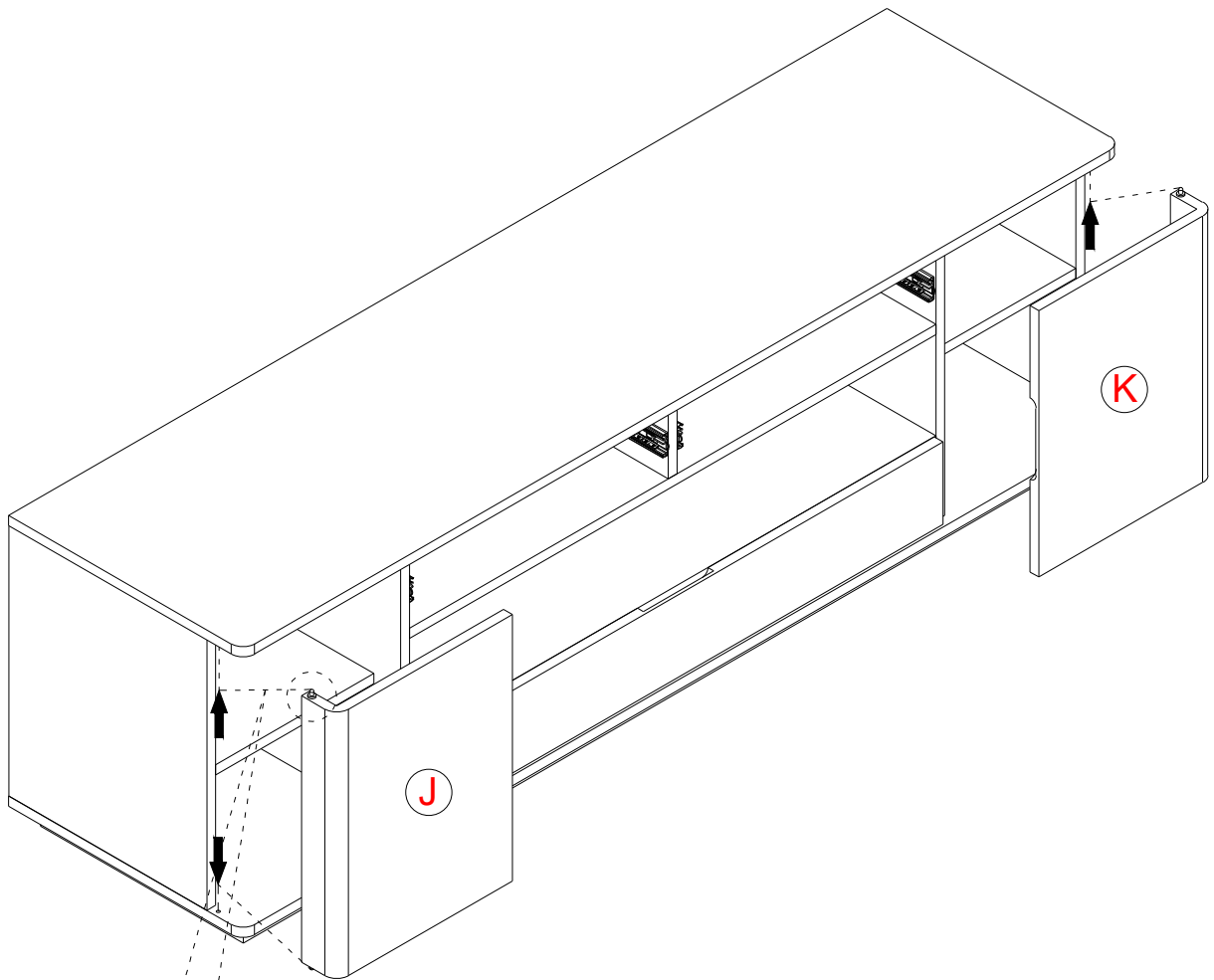

ASSEMBLY INSTRUCTIONS

12

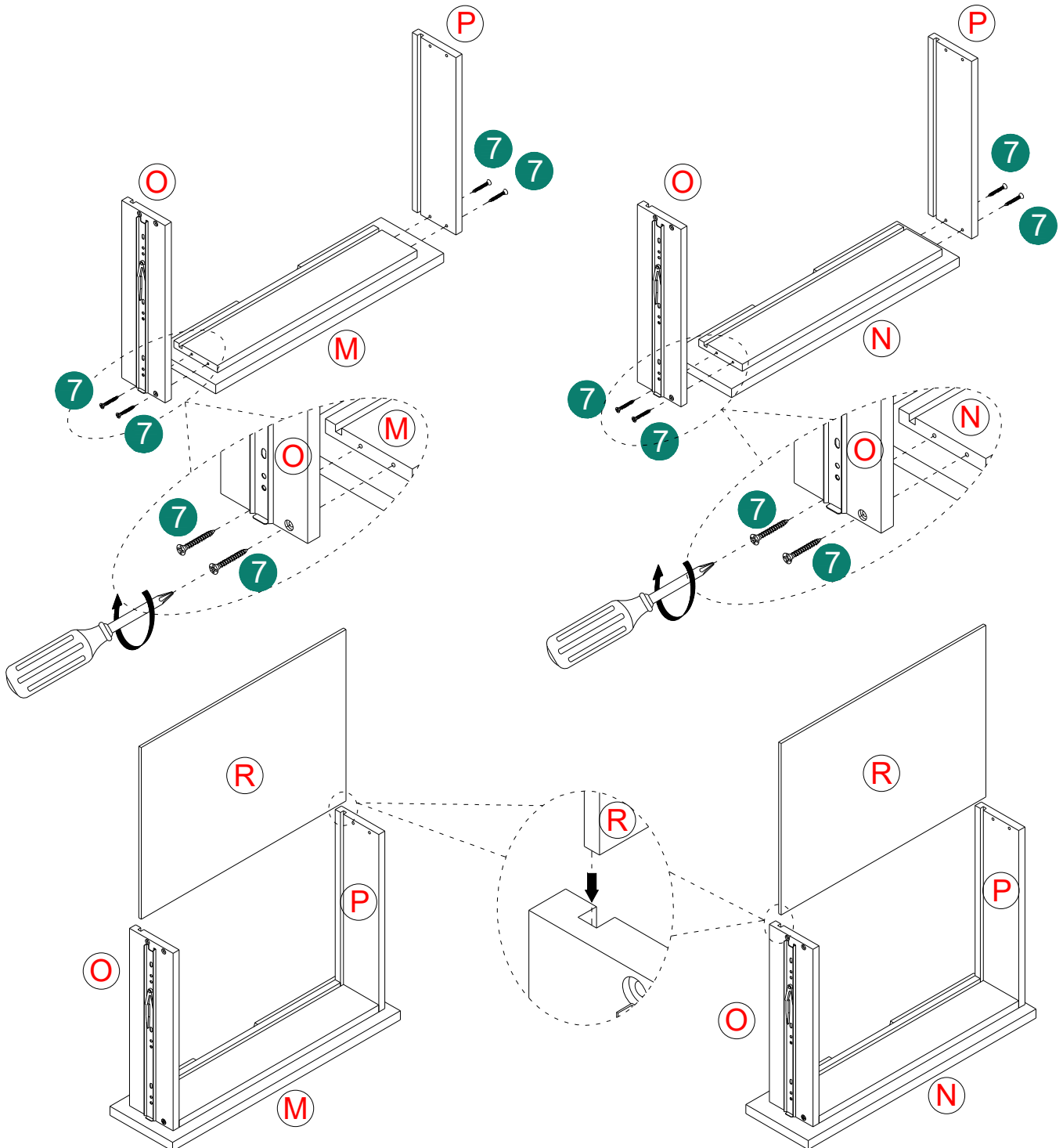
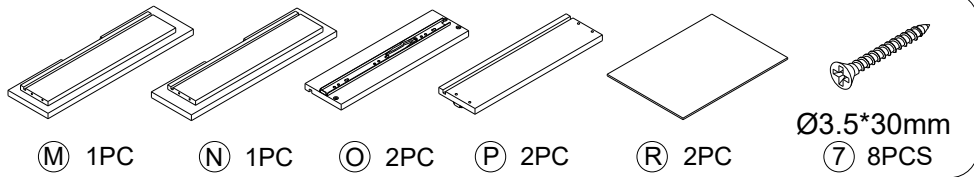

ASSEMBLY INSTRUCTIONS

13

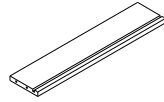

Q 2PCS

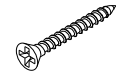

Ø3.5*30mm

7 8PCS

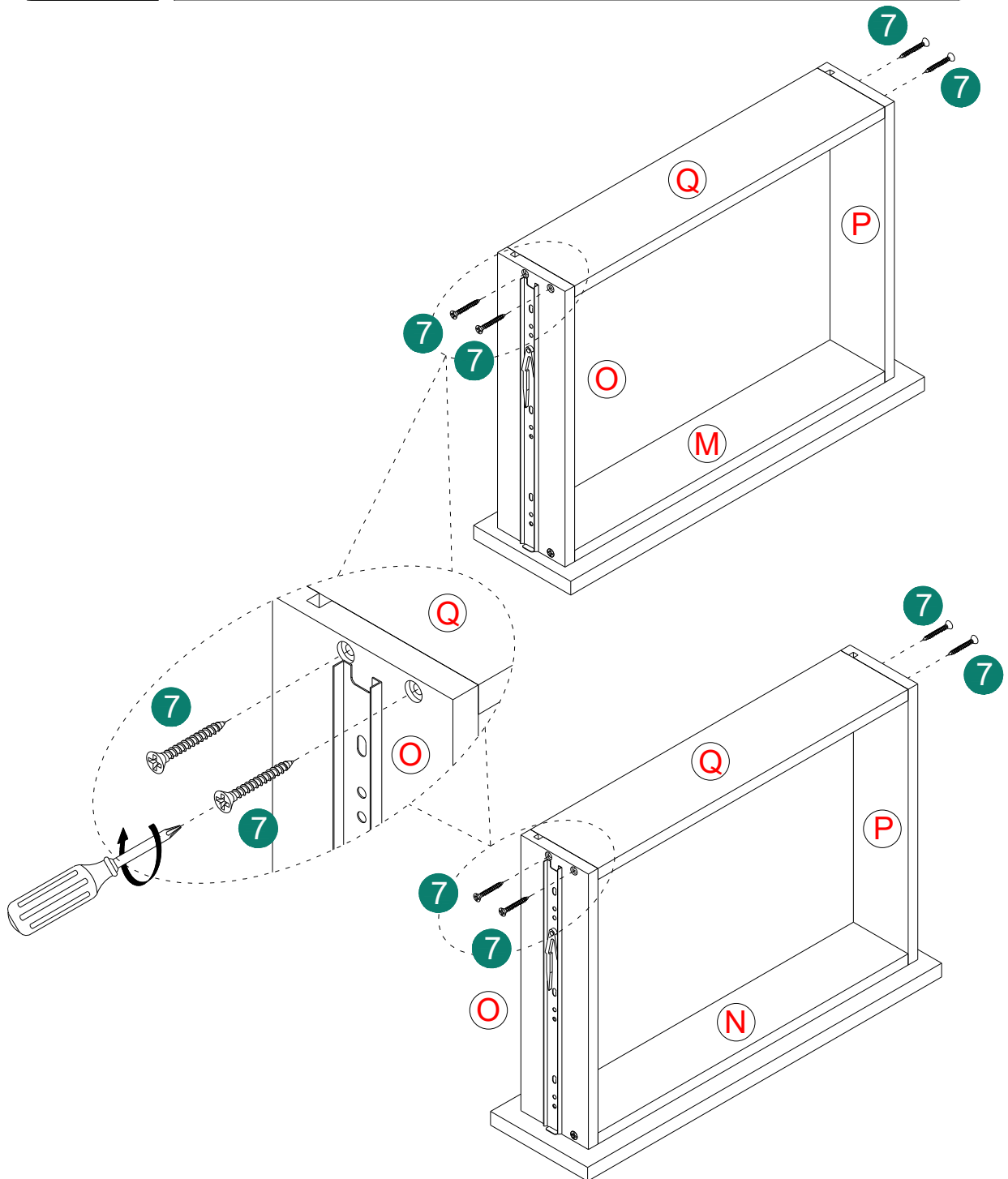

ASSEMBLY INSTRUCTIONS

14

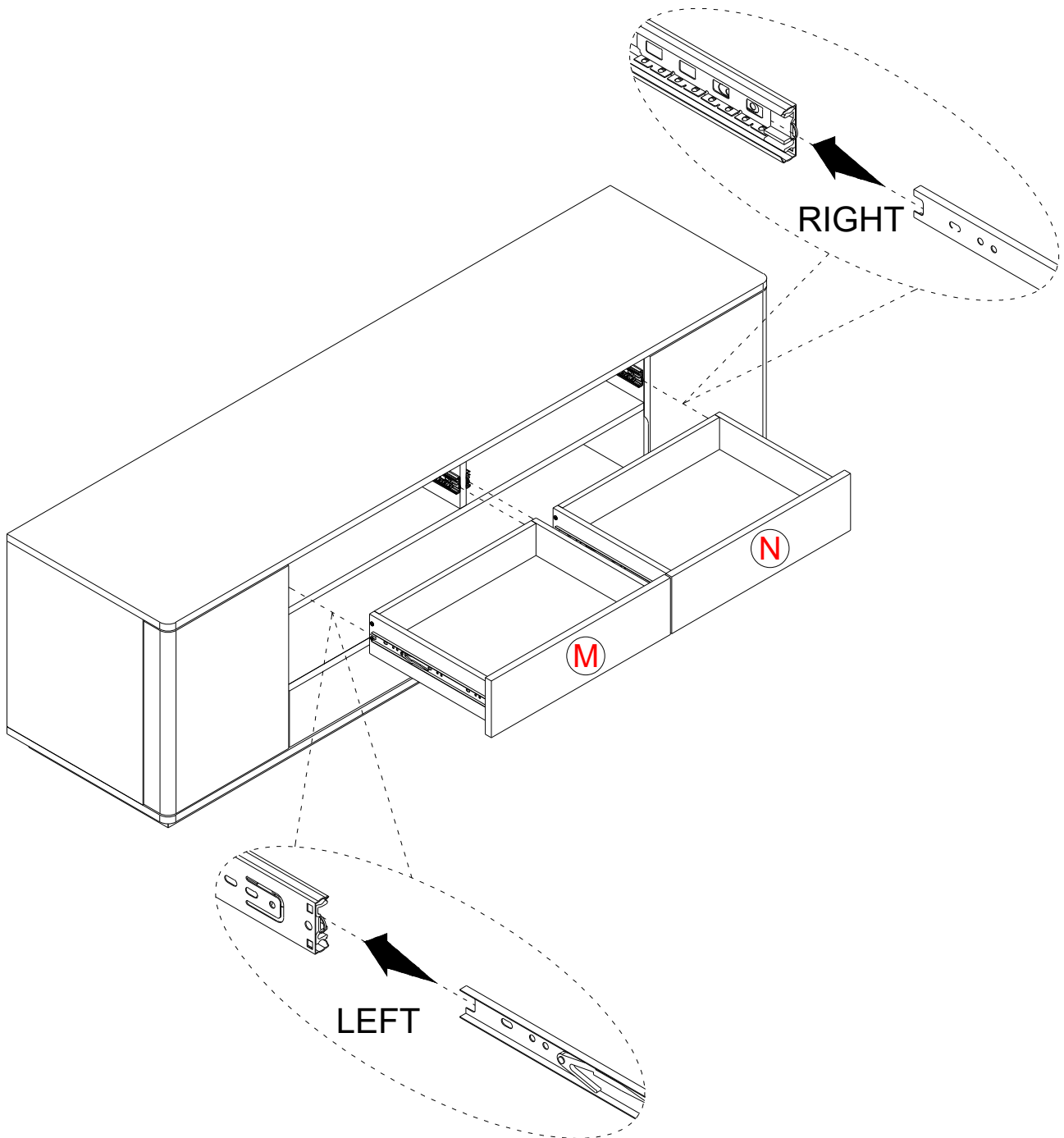

18