

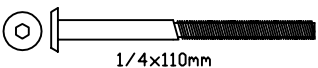

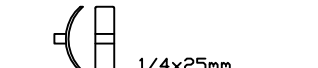

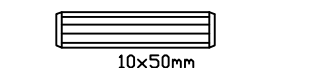

4'6" DOUBLE BED

HARDWARE LIST		
A	 1/4x110mm	08
B	 1/4x25mm	08
C	 10x50mm	04
D	 3,5x16 mm	10
E	 3,5x35mm	24
F	 ALLEN KEY	01
G	 SPACER	02
H		02
I	 7x80mm	02

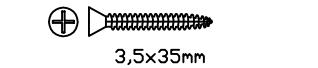
USE OF POWER TOOL TO ASSEMBLE THE PRODUCT WILL INVALIDATE ANY CLAIM AND COULD MAKE THIS PRODUCT UNSAFE.

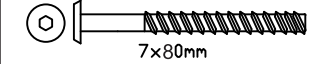
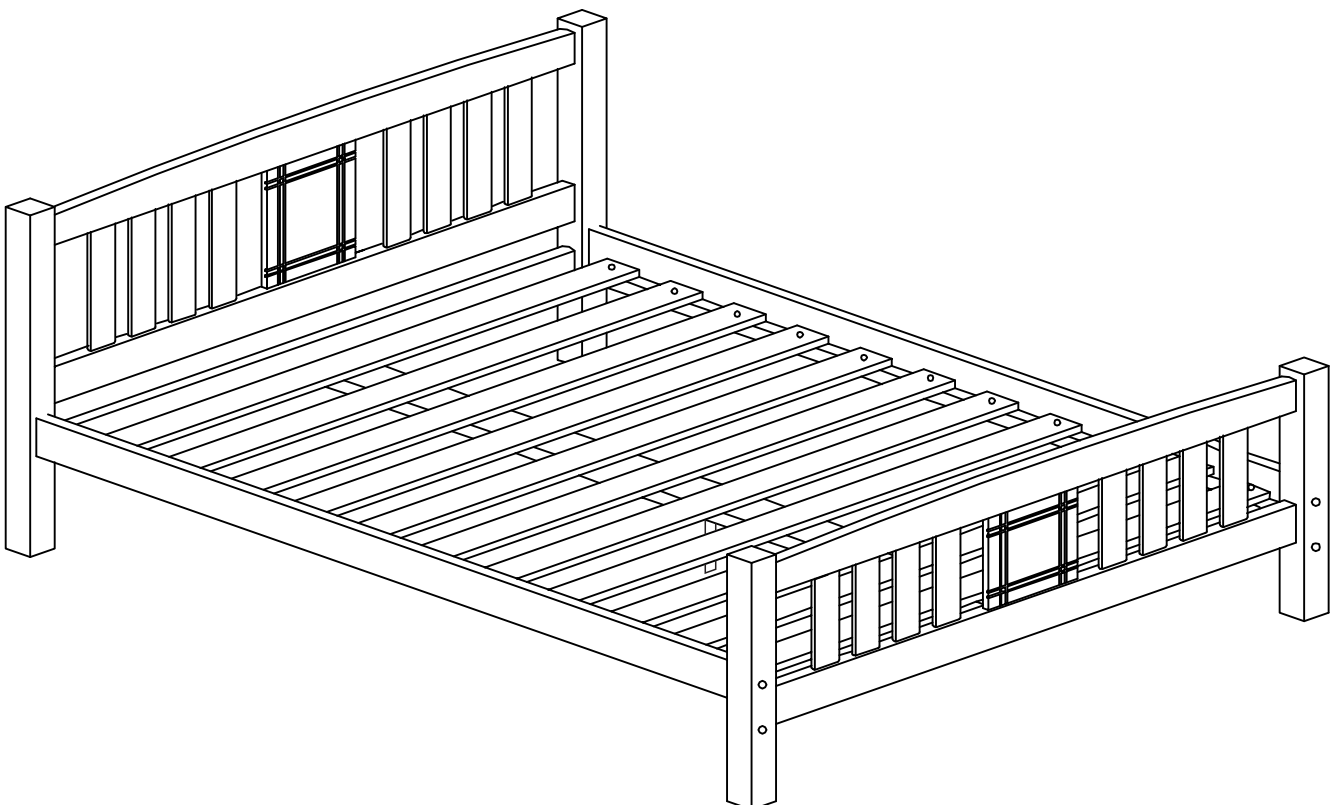

N°	QTY
01	01
02	01
03	02
04	12
05	01
06	02

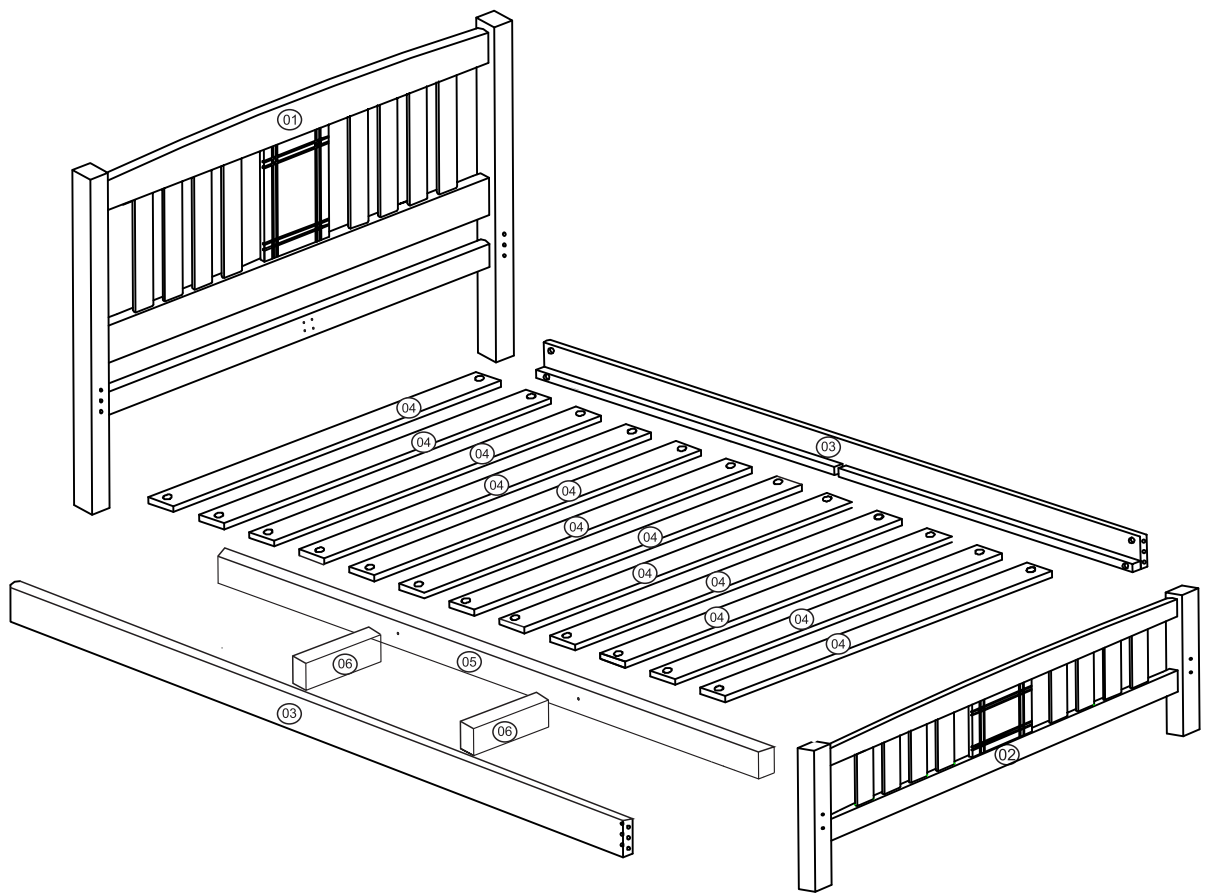

BEDS WITH CENTRE LEGS

PLEASE NOTE THE RECOMMENDED PROCESS FOR ADJUSTING CENTRE LEGS WHEN ASSEMBLING YOUR BED.

BEFORE PLACING THE MATTRESS ON THE BASE, PLEASE ENSURE THAT THE SUPPORT LEGS ARE NOT QUITE TOUCHING THE FLOOR. WHEN THE BED IS THEN IN USE THE SUPPORT LEGS WILL SIT FIRMLY ON THE SOLID SURFACE.

PLEASE ENSURE THAT THE LEGS ARE VERTICAL

DUE TO THE NATURE OF LAMINATE FLOORING WE RECOMMEND THAT YOU PLACE A SMALL PIECE OF NON SLIP MATERIAL UNDER THE LEGS WHICH WILL GIVE YOU THE FLEXIBILITY THAT THE ADJUSTERS NEED.

WHEN MOVING THE BED IT IS ESSENTIAL THAT IT IS LIFTED INTO THE NEW POSITION. **NEVER DRAG** THE BED AS THIS WILL MOVE THE LEGS FROM THE VERTICAL POSITION THUS WEAKENING THE SUPPORT OF THE CENTRE RAIL.

ADHERING TO THE RECOMMENDED PROCESS SHOULD ENSURE THAT YOUR BED GIVES YOU YEARS OF TROUBLEFREE SERVICE.

THANK YOU

CARING FOR YOUR NEW PRODUCT

- **PLEASE NOTE:** GOODS THAT NEED TO BE RETURNED SHOULD BE SENT BACK IN ITS ORIGINAL PACKAGING.
- When assembling your bed, please ensure that you have checked the contents for all relevant parts.
- When tightening bolts, do make sure that they are fully tightened but not forced.
- When moving your fully assembled bed, you must first remove the mattress and lift the frame into position; taking care when lifting and always have two people handling the bed. PLEASE DO NOT DRAG THE BED as this will cause damage to the central support legs and rail. Central legs MUST be in a vertical position at all times.
- Due to the nature of laminate flooring, we recommend that you place non-slip material under the central support legs. This will stop the legs from sliding on laminate/wooden floors and will prevent the bed from collapsing.
- It is advisable to use approved cleaning products when cleaning the furniture and bed frame as certain chemical-based cleaners could have an adverse effect on the bed's finish.
- All beds are produced to the highest standards and are packed to avoid damage in transit. Should you find that your new bed does not meet your satisfaction, please contact our Customer Service Department.

01

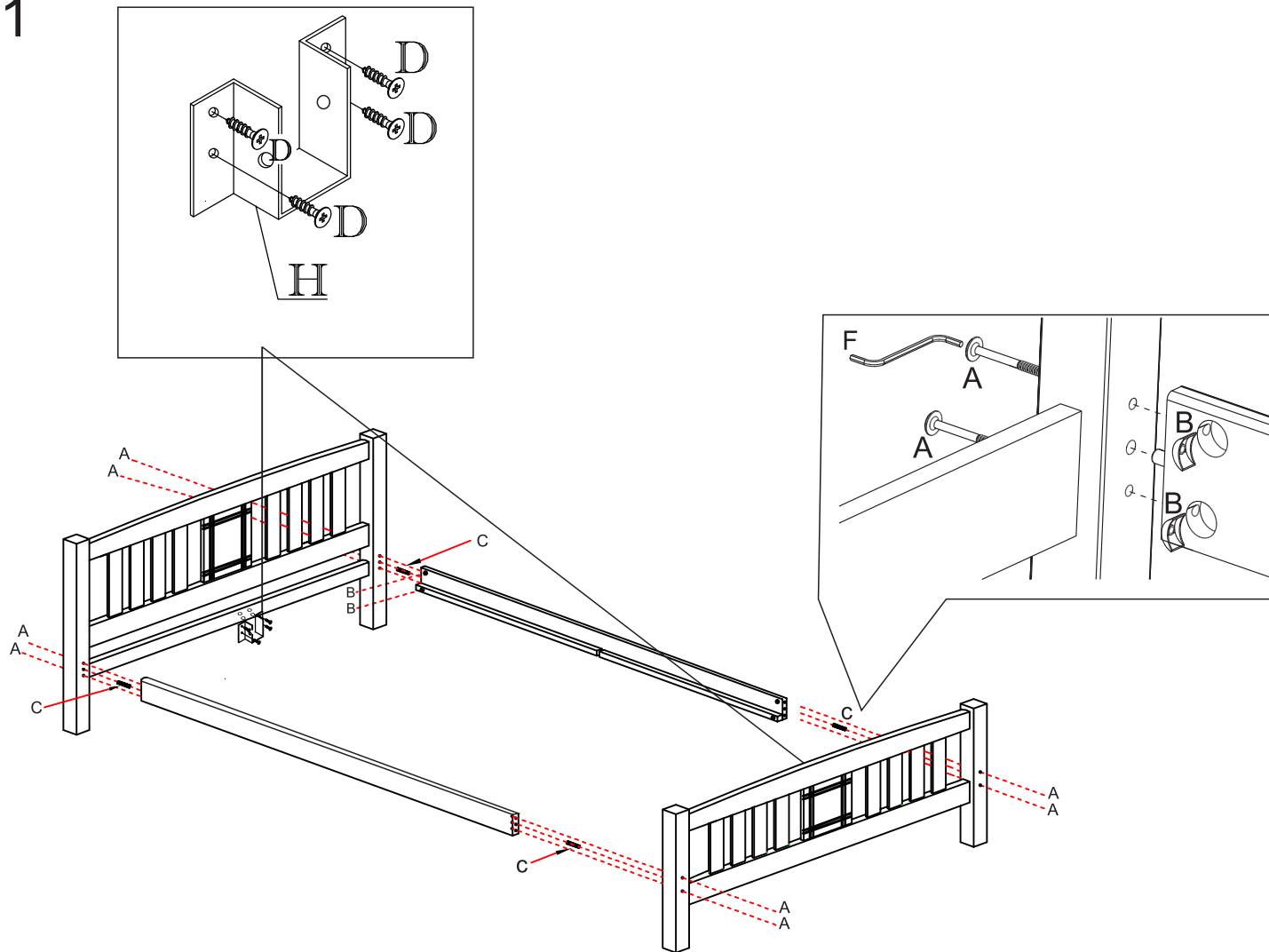

02

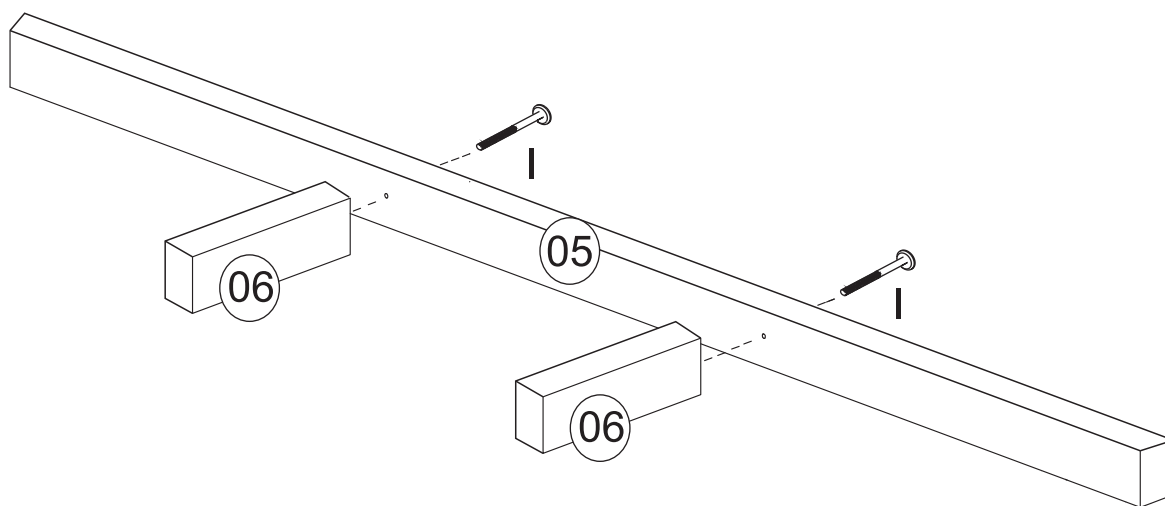

03

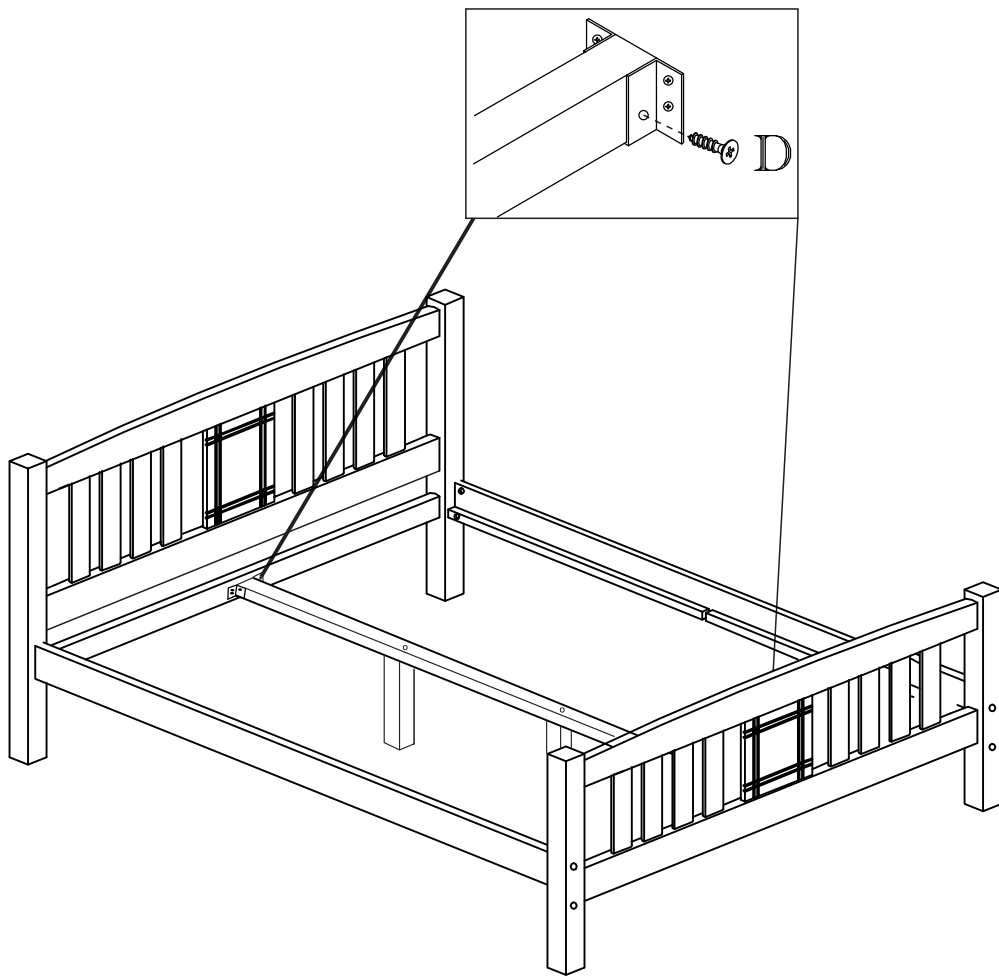

04

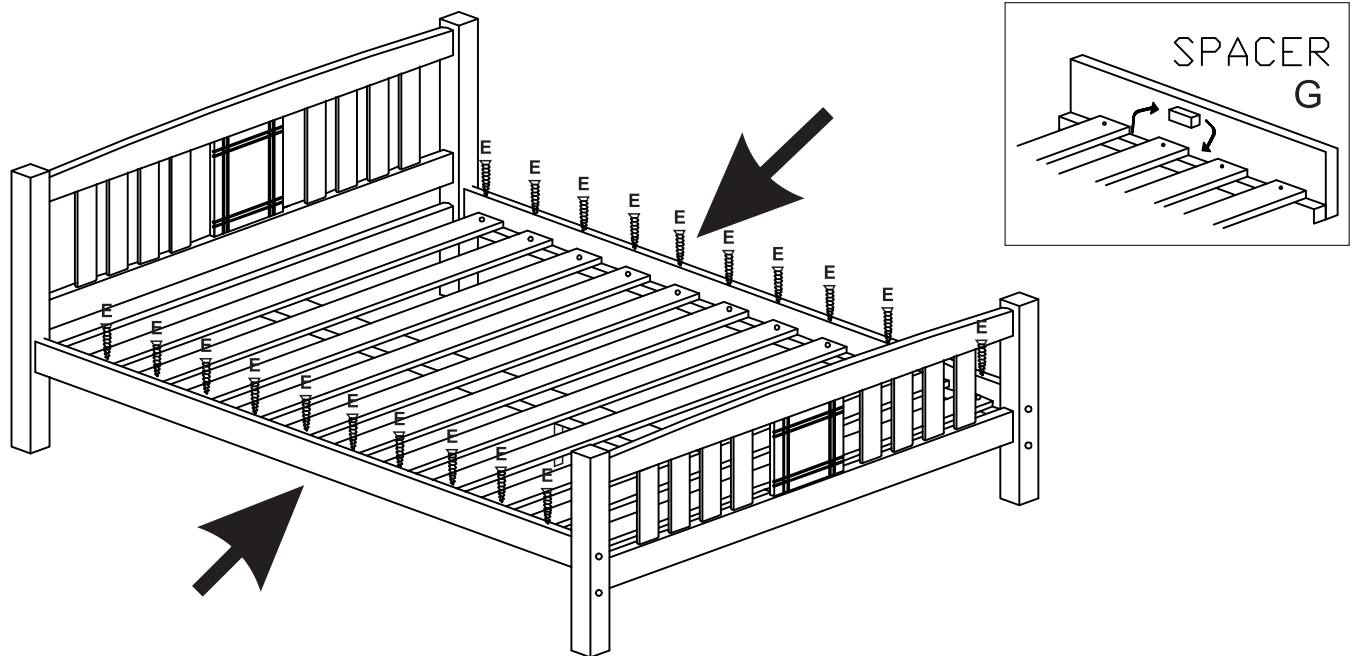

*** PLEASE NOTE ***

**YOU MAY NEED TO PUSH THE SIDERAILS
IN ON BOTH SIDES SO THAT THE SLATS
FIT THE SIDE RAIL SHELF**