

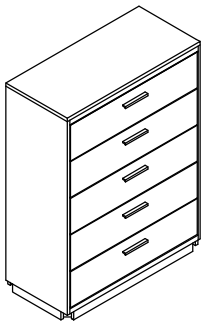

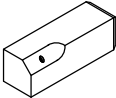

ASSEMBLY INSTRUCTION

NO	PARTS LIST		QTY
A	Chest		1
B	Feet		4
NO	HARDWARE LIST		QTY
C	Bolt		4
D	Spring Washer		4
E	Washer $\text{O}\frac{1}{4}$ " x 20mm		4
F	Allen Key M4		1

STEP 1

Take out Assembly Instruction sheet, Hardware Pack and Feet Packaging from bottom of unit which marked with the rope.

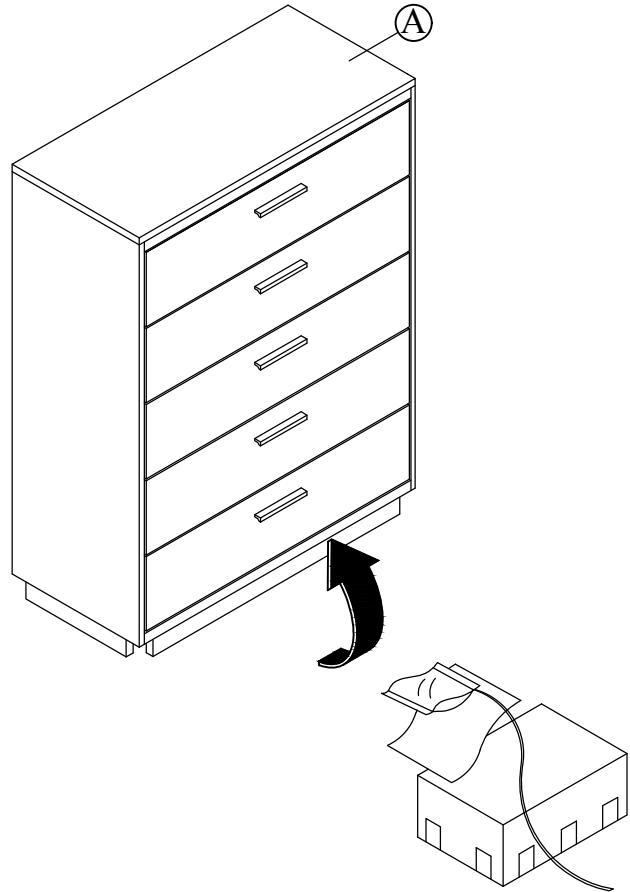

STEP 2

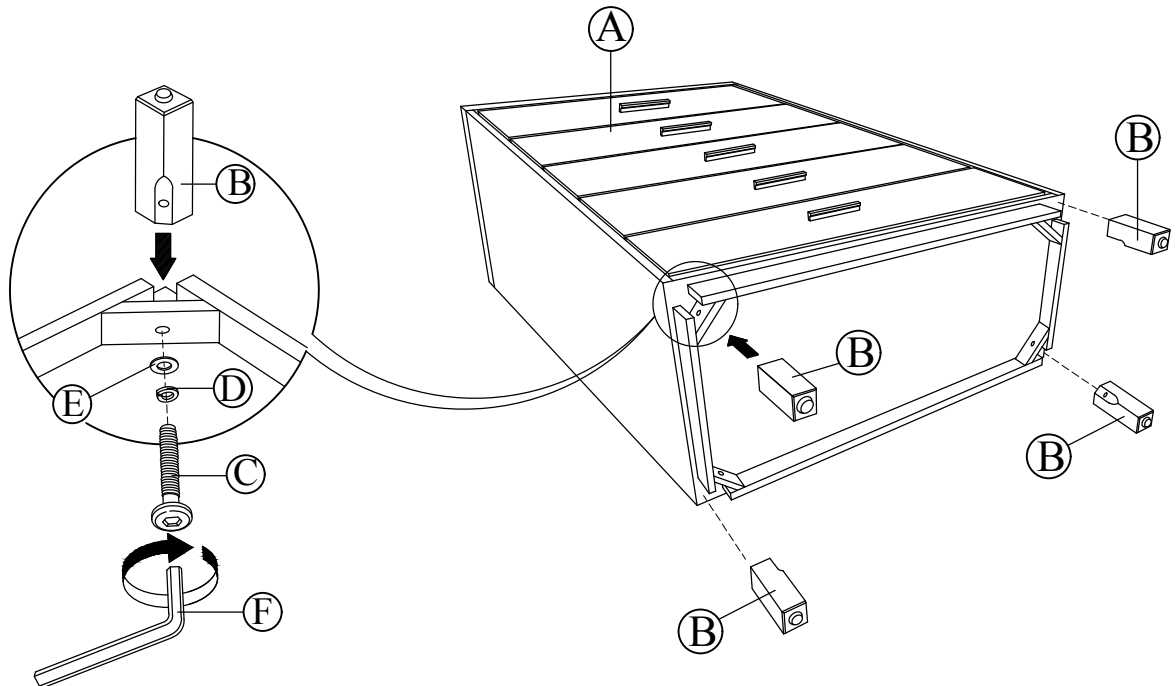

Insert Leg (B) at position as shown and tighten with JCBC Screw (C), Spring Washer (D) & Flat Washer (E) by using Allen key (F)