

USER MANUAL

CAUTION

1. BE SURE THE ELECTRICITY TO THE WIRES YOU ARE WORKING ON IS SHUT OFF; EITHER THE FUSE IS REMOVED OR THE CIRCUIT BREAKER IS TURNED OFF. TURNING THE POWER OFF USING THE LIGHT SWITCH IS NOT SUFFICIENT TO PREVENT ELECTRICAL SHOCK.
2. DO NOT INSTALL OR USE THE LIGHT FIXTURE IF ANY PART IS MISSING OR DAMAGED. CONTACT YOUR DEALER FOR REPLACEMENT OR MISSING PARTS.
3. SOME METAL PARTS IN THE LIGHT FIXTURE MAY HAVE SHARP EDGES. TO PREVENT CUTS OR SCRAPES. WEAR GLOVES BEFORE INSTALLATION.
4. TO PROTECT THE FINISH, WEAR GLOVES BEFORE INSTALLATION, DO NOT USE CLEANSERS OR ABRASIVES DURING MAINTENANCE.
5. TO AVOID POSSIBLE FIRE OR ELECTRICAL SHOCK, MAKE SURE NO BARE WIRE STRANDS ARE EXPOSED OUTSIDE WIRE CONNECTORS.



6. IF IN DOUBT ABOUT ELECTRICAL INSTALLATION, CONSULT A LICENSED ELECTRICIAN.

INSTALLATION DIAGRAM

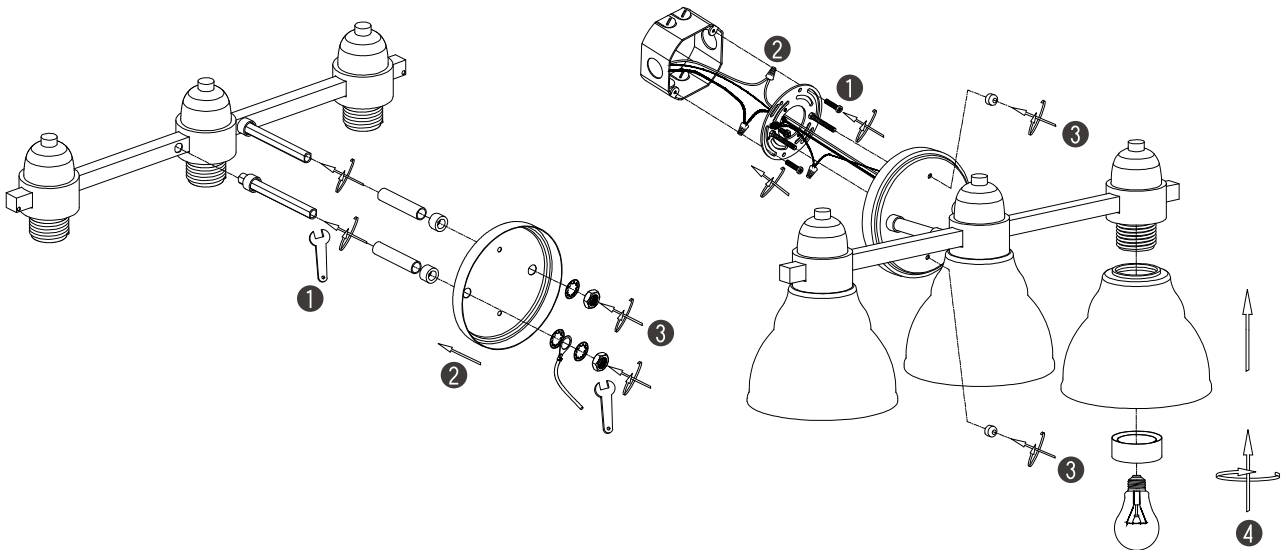

CAUTION

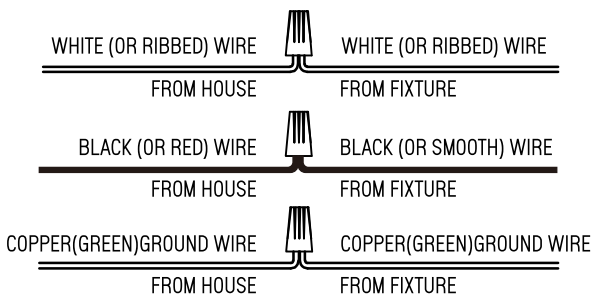

PARTS BAG

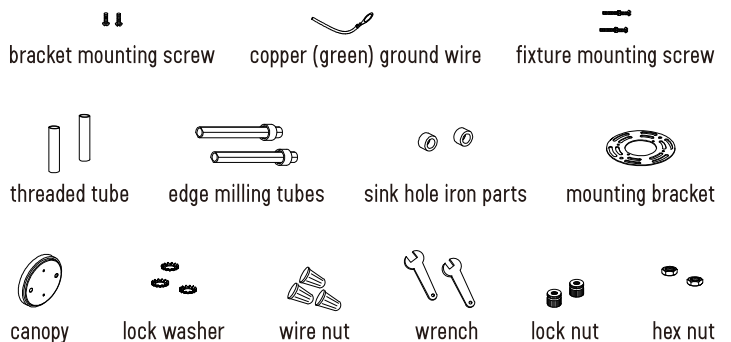

DIMENSION

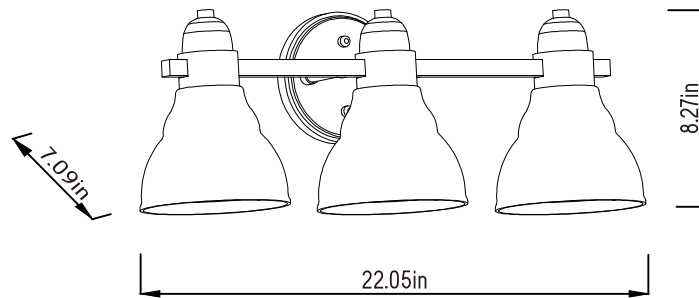

NTJH001 - 3

SPECIFICATIONS

Model	Bulb Base	Voltage	Wattage	Size(in)
NTJH001 - 3	E26	120V/60Hz	MAX 60W x 3	L22.05" x W7.09" x H8.27"

LIMITED WARRANTY

The manufacturer warrants all of its lighting fixtures against defects in materials and workmanship for one year from the date of purchase. If within this period the product is found to be defective in material or workmanship, the product must be returned, with a copy of the original sales receipt as proof of purchase. The manufacturer will, at its option, replace or refund the original purchase price to the consumer. This warranty does not cover fixtures becoming defective due to misuse, accidental damage, improper handling and/or installation and specifically excludes liability for direct, incidental or consequential damages. As some states do not allow exclusions or limitations on an implied warranty, the above exclusions and limitations may not apply to you. This warranty gives you specific legal rights, and you may have other rights that vary from state to state.



General Coverage

Brand name
Model No.: NTJH001
CONFORMS TO UL STD.1598
CERTIFIED TO CSA STD.C22.2 No.250.0
Zhongshan Haili Lighting Electrical
Appliance Co.,Ltd.