

Note:

First, you must wear gloves to avoid scratching your hands.

Second, two people are required to install it.

Third, it takes forty minutes for two people.

Fourth, a cross screwdriver is required, and the best tool is an electric screwdriver, which can save half of the time.

Disassembly diagram of the frame part

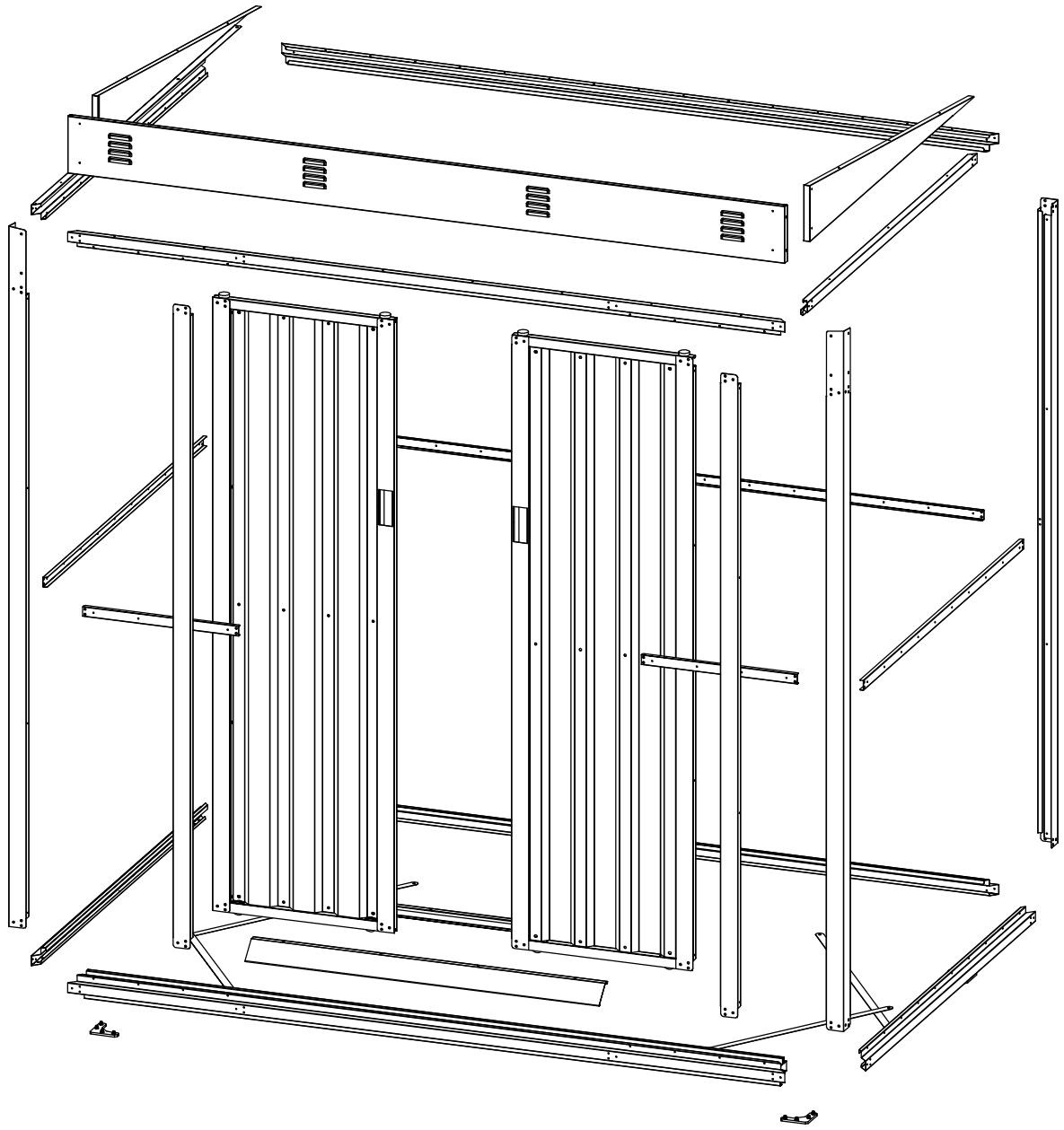

Disassembly diagram of corrugated board part

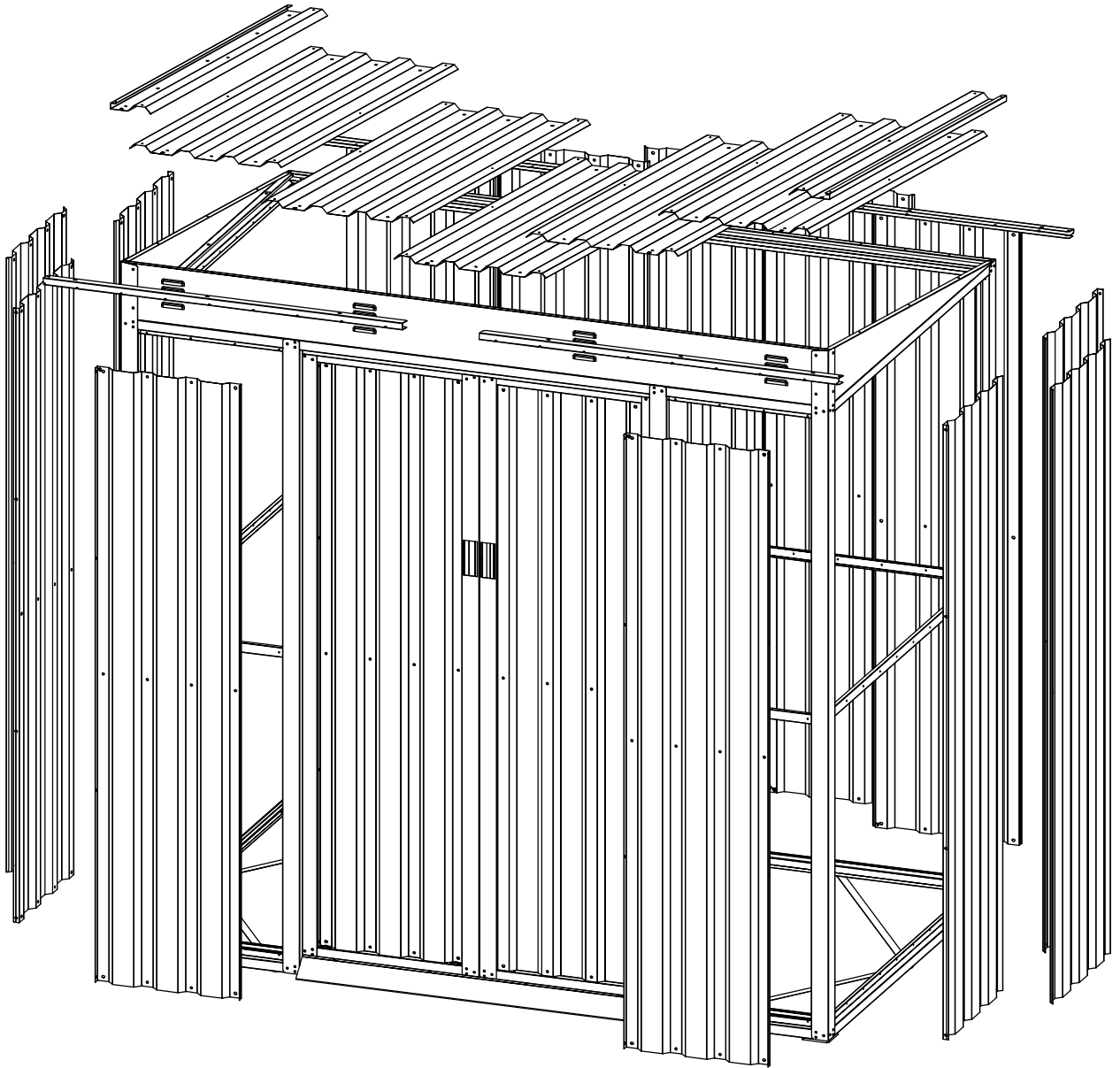

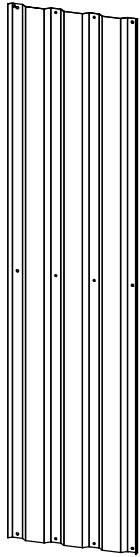

A 6PCS

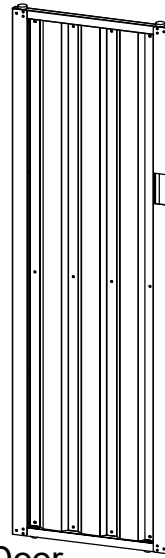

Left Door

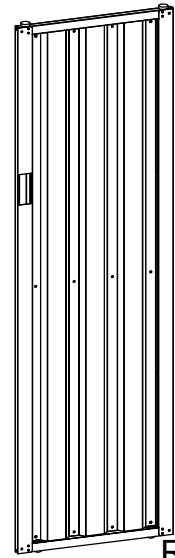

Right Door

D 2PCS

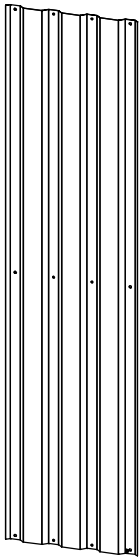
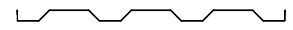

B 5PCS

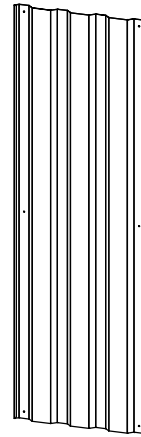
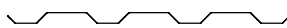

E 5PCS

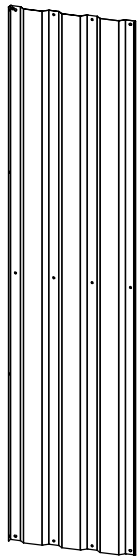
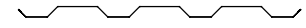









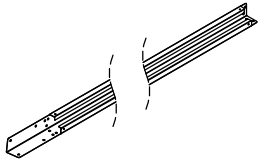

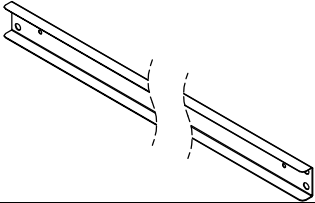

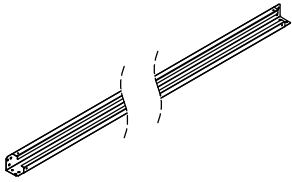

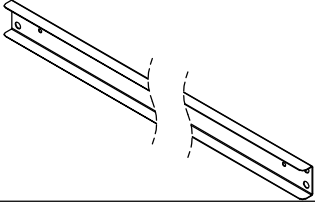

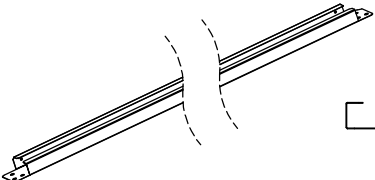

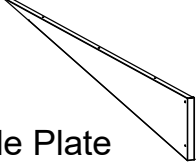
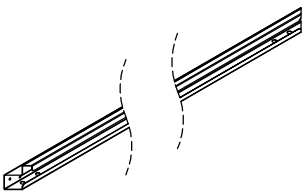

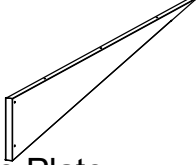
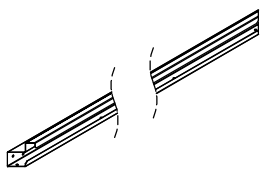

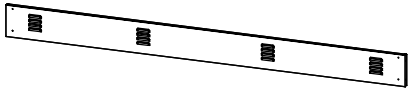
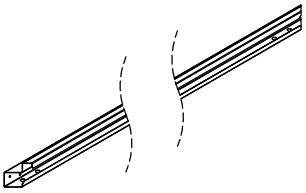

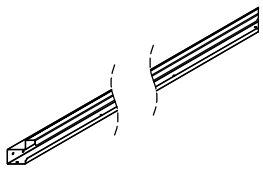
C 2PCS

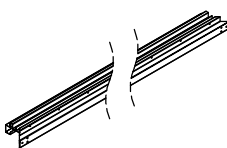
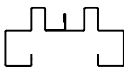
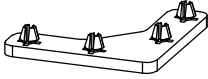
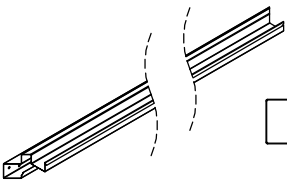
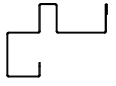

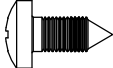
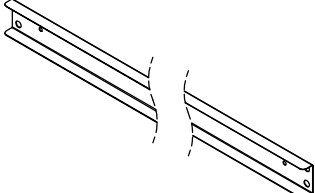
F 2PCS

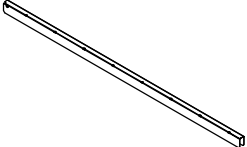

G			2PCS	Q			2PCS
H			2PCS	R			2PCS
I			2PCS	S		Left Side Plate	1PC
J			2PCS	T		Right Side Plate	1PC
K			2PCS	U			1PC
L			2PCS	V			2PCS
M			2PCS	W			4PCS
N			1PC	X			4PCS
O			1PC	Y			350PCS
P			1PC	Z			4PCS



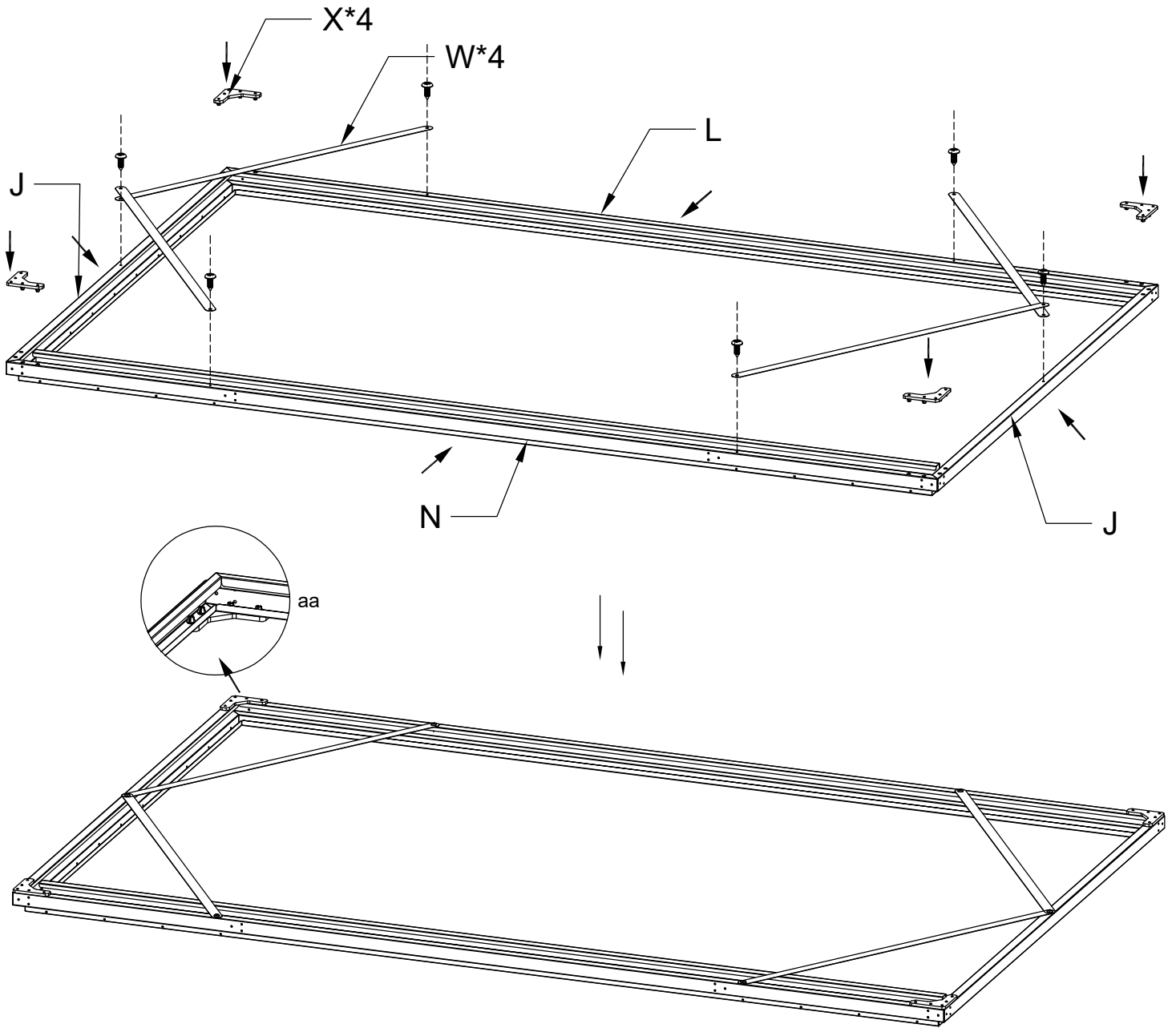



Step 1: Install the bottom frame to ensure that four triangles (X) clip into the four corners of the bottom frame, as shown in picture aa. In this step, the bottom frame faces downward for easy installation.

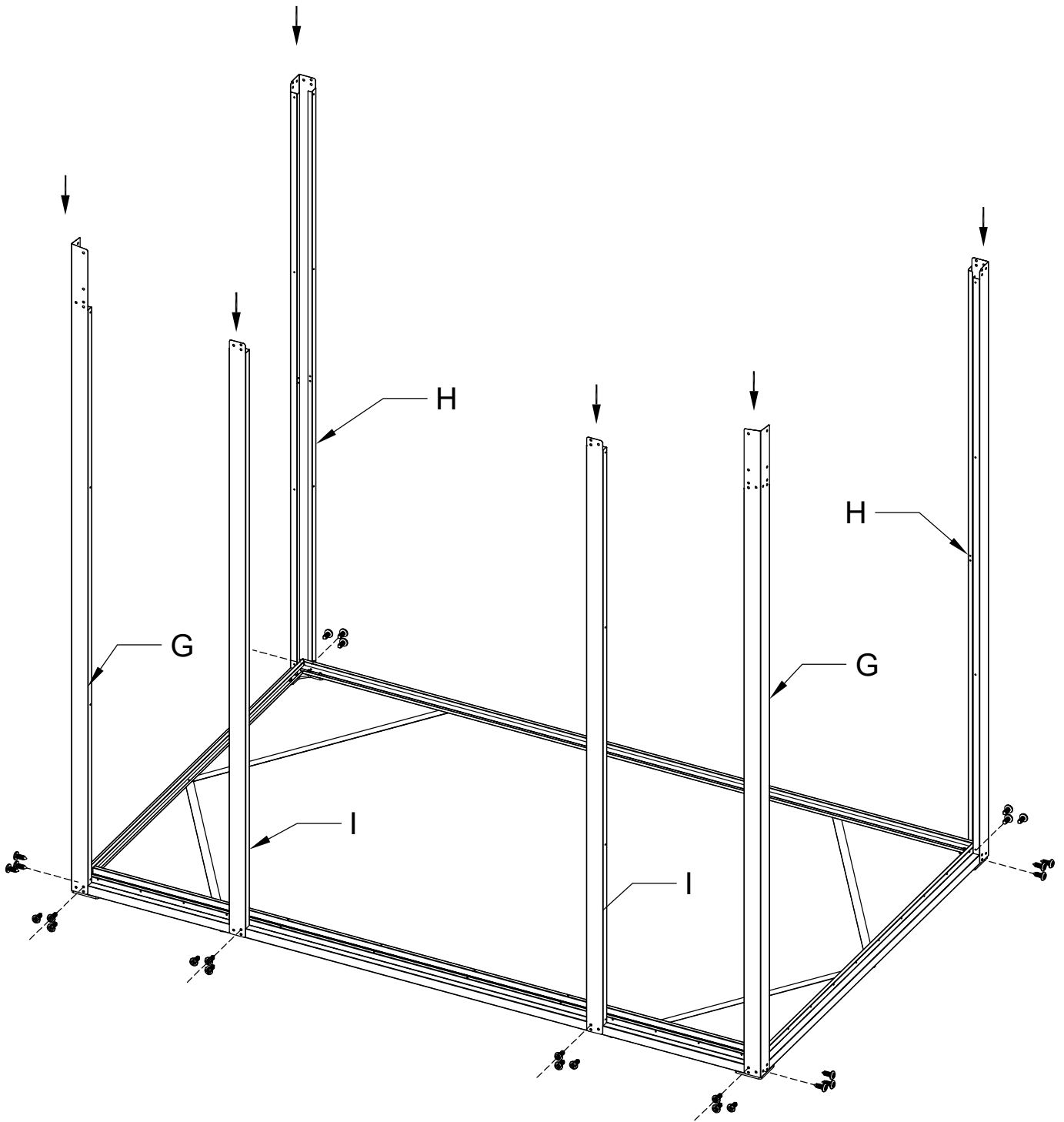

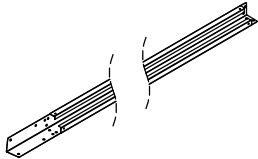
J		2PCS	W		4PCS
L		1PC	X		4PCS
N		1PC	Y		6PCS

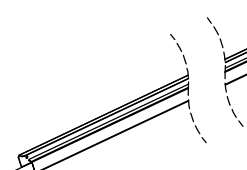

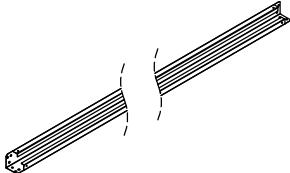

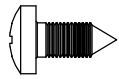



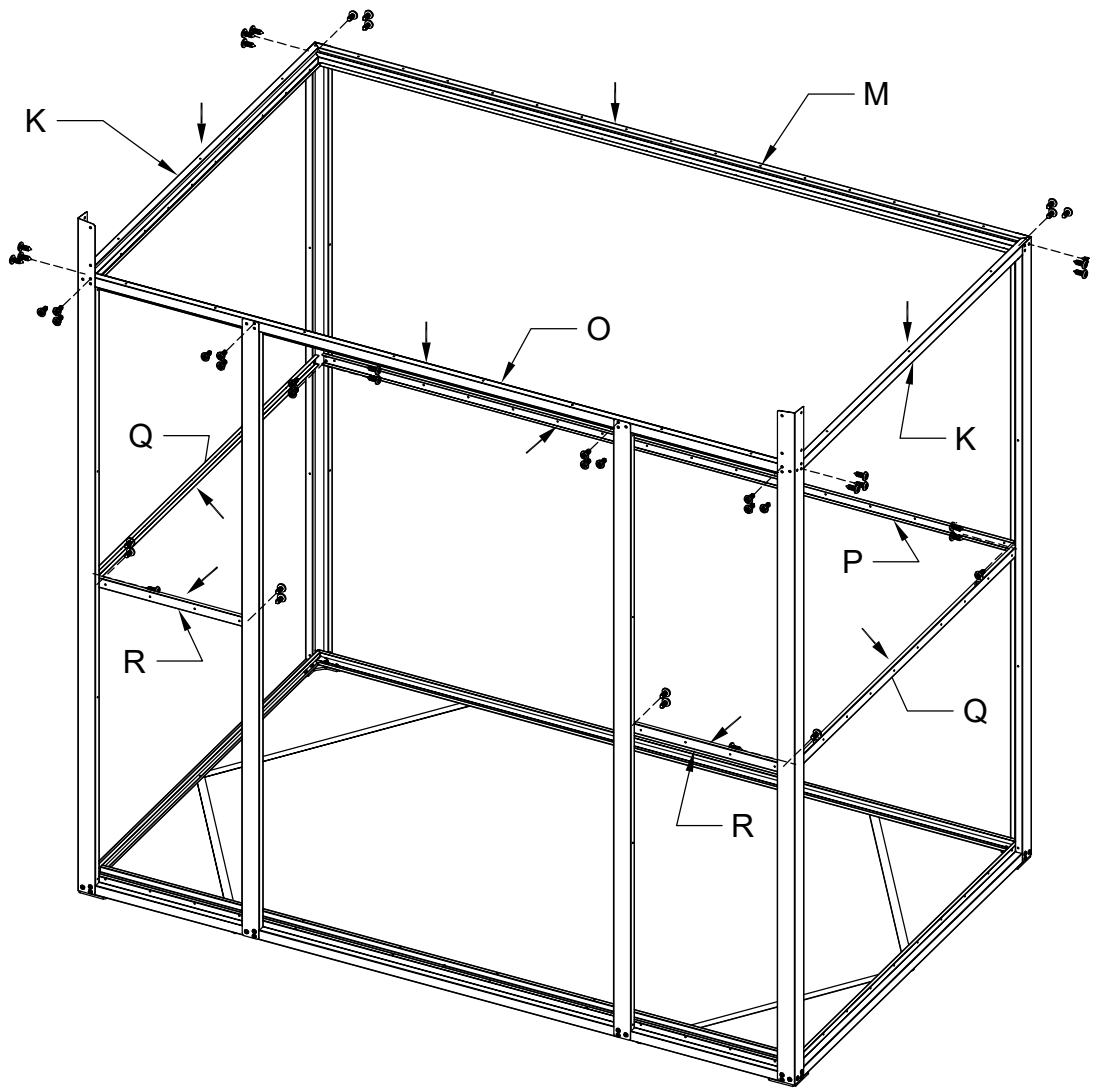

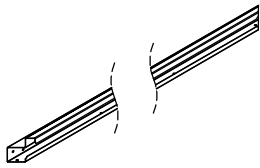
Step 2: Install the rear corner column (H)*2, the front corner column (G)*2, and the front vertical support (I)*2.
 In this step, notice that the bottom frame is facing up.

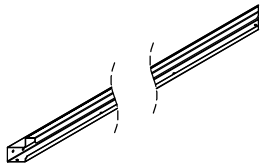

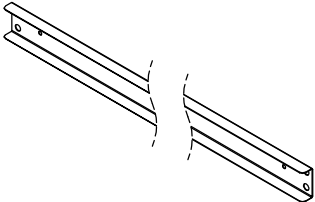
G	 	2PCS	I	 	2PCS
H	 	2PCS	Y	 	30PCS

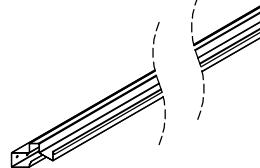
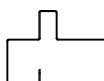
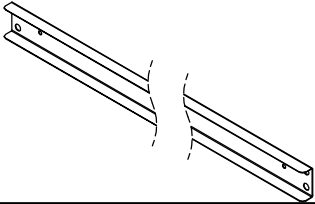
Step 3: Install the waist frame and the top frame.

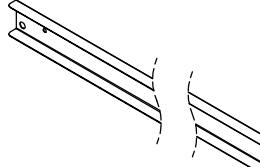

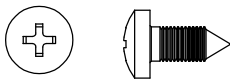
<p>K</p>	 	<p>2PCS</p>	
<p>M</p>	 	<p>1PC</p>	<p>Q</p>   <p>2PCS</p>
<p>O</p>	 	<p>1PC</p>	<p>R</p>   <p>2PCS</p>
<p>P</p>	 	<p>1PC</p>	<p>Y</p>  <p>50PCS</p>

Step 4: Install the left , right side panels and the front panel.

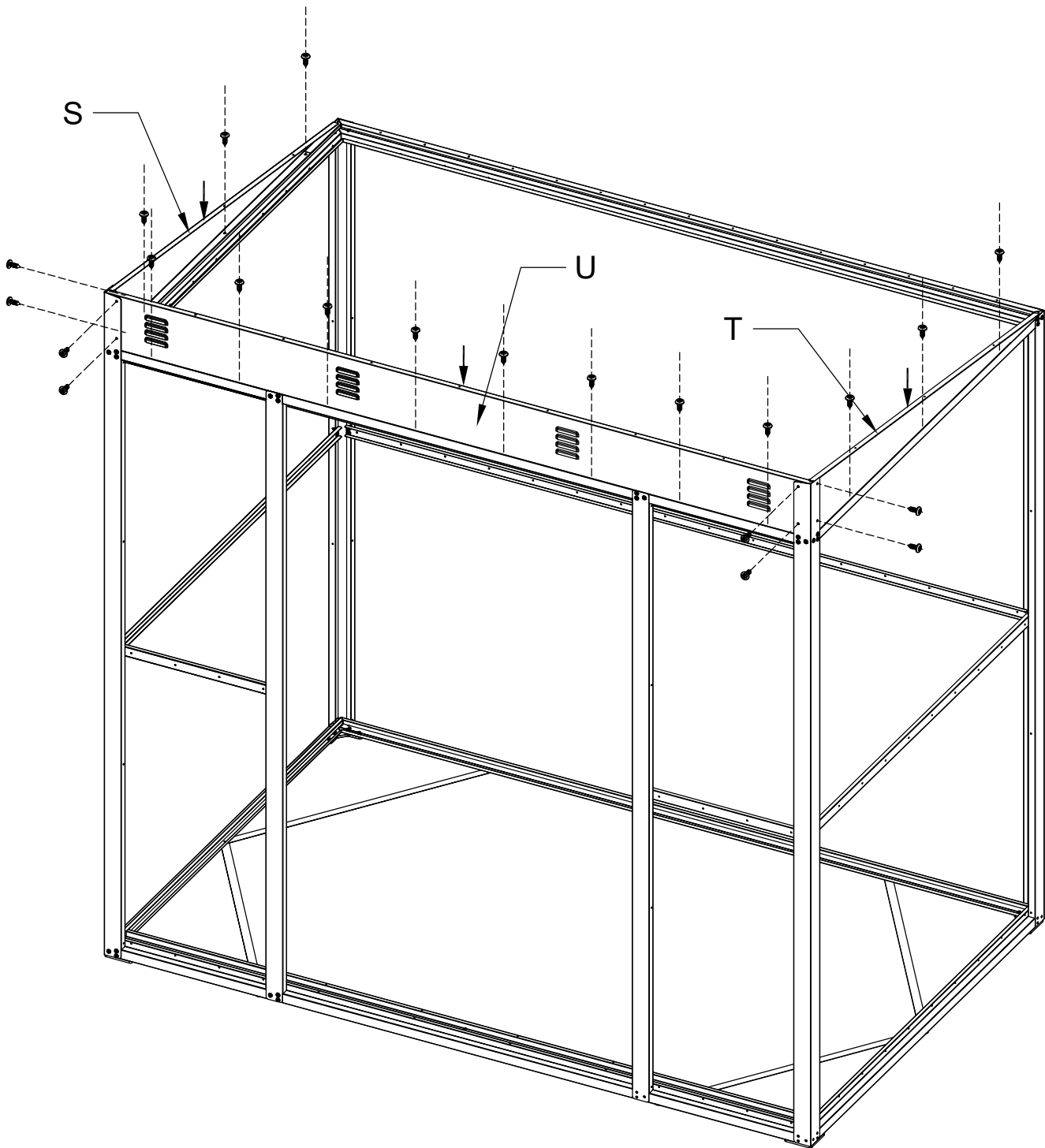

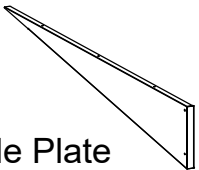
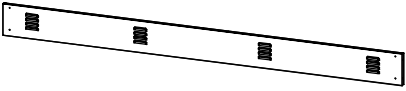
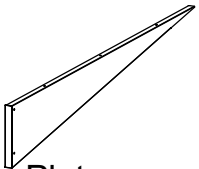
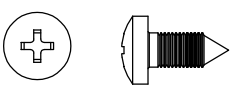
<p>S</p>	 <p>Left Side Plate</p>	<p>1PC</p>	<p>U</p>		<p>1PC</p>
<p>T</p>	 <p>Right Side Plate</p>	<p>1PC</p>	<p>Y</p>		<p>22PCS</p>

Step 5: Install the left and right door panels. Align the pulley on the door with the mounting hole of the upper chute and lift up, as shown in picture bb, and then push the lower pulley forward into the slide, ensure that the lower wheels are riding on the slide, as shown in picture cc.

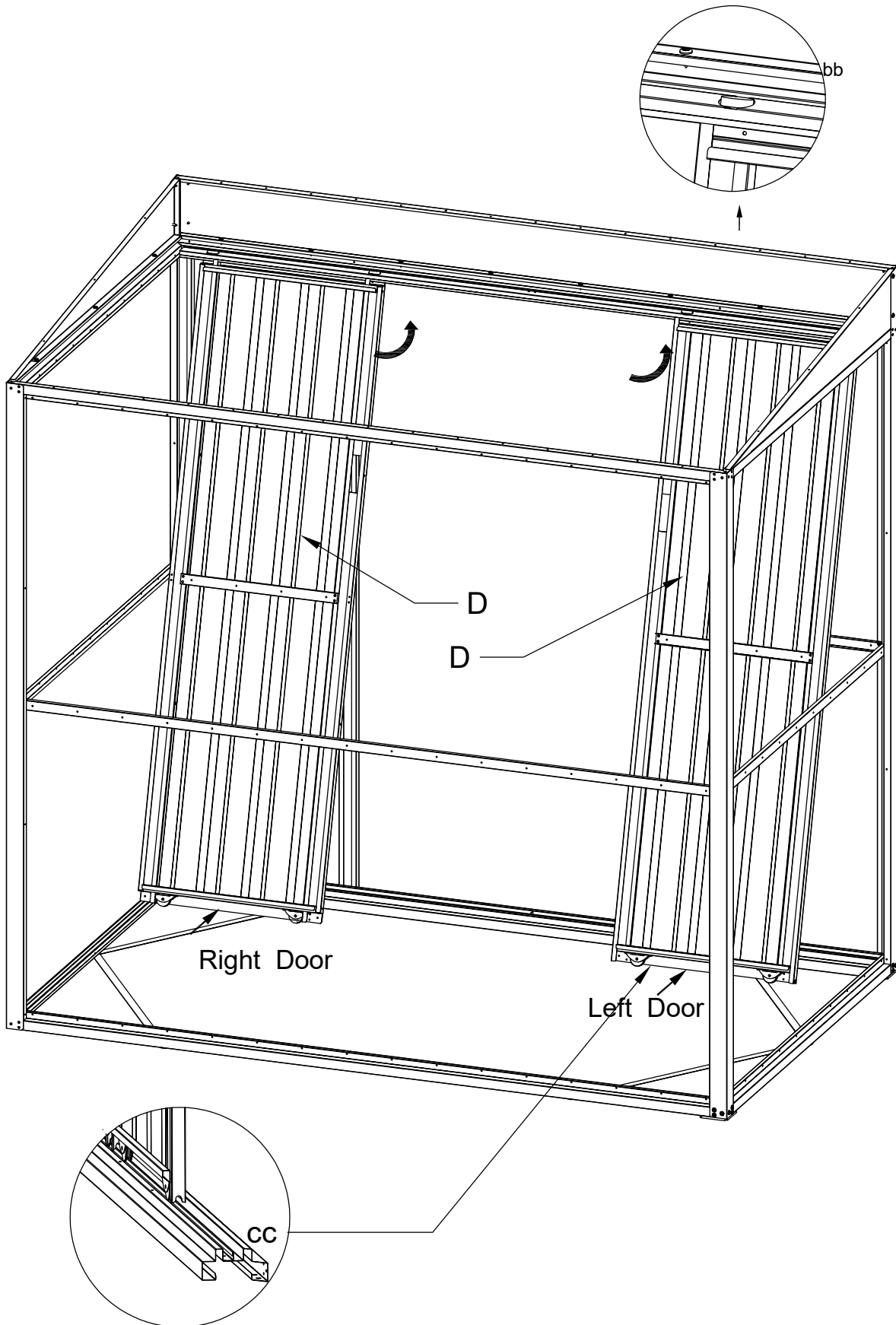

D

2PCS

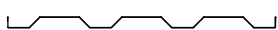

Step 6: Install the door ramp (V)*2.

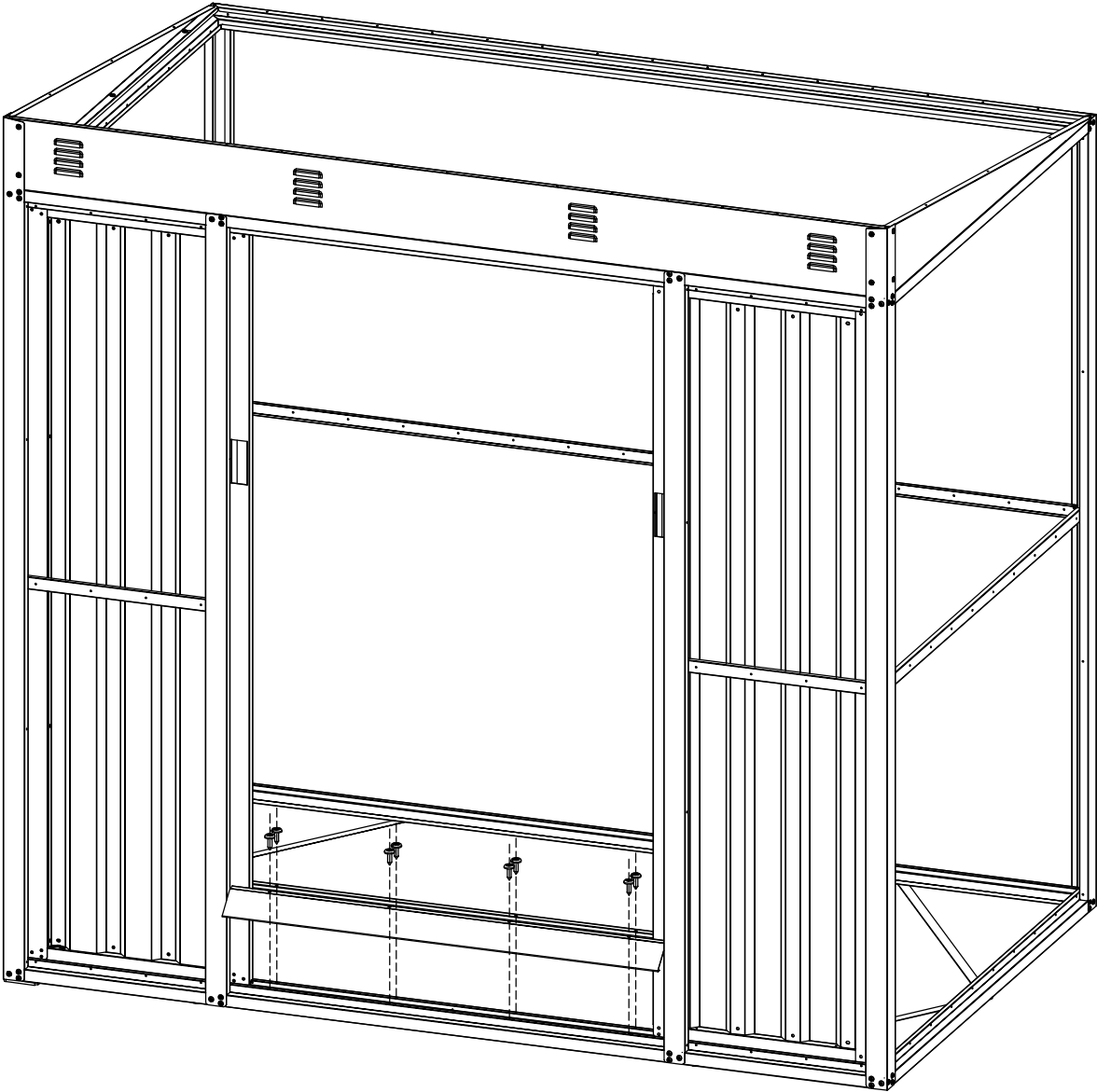

V

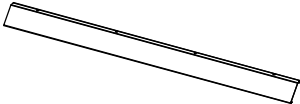

2PCS

Y

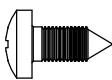

8PCS

Step 7: Install the top middle board (E) and the side board (F), as shown in the picture, you must install (E) first and then install (F), layer by layer to avoid water leakage.

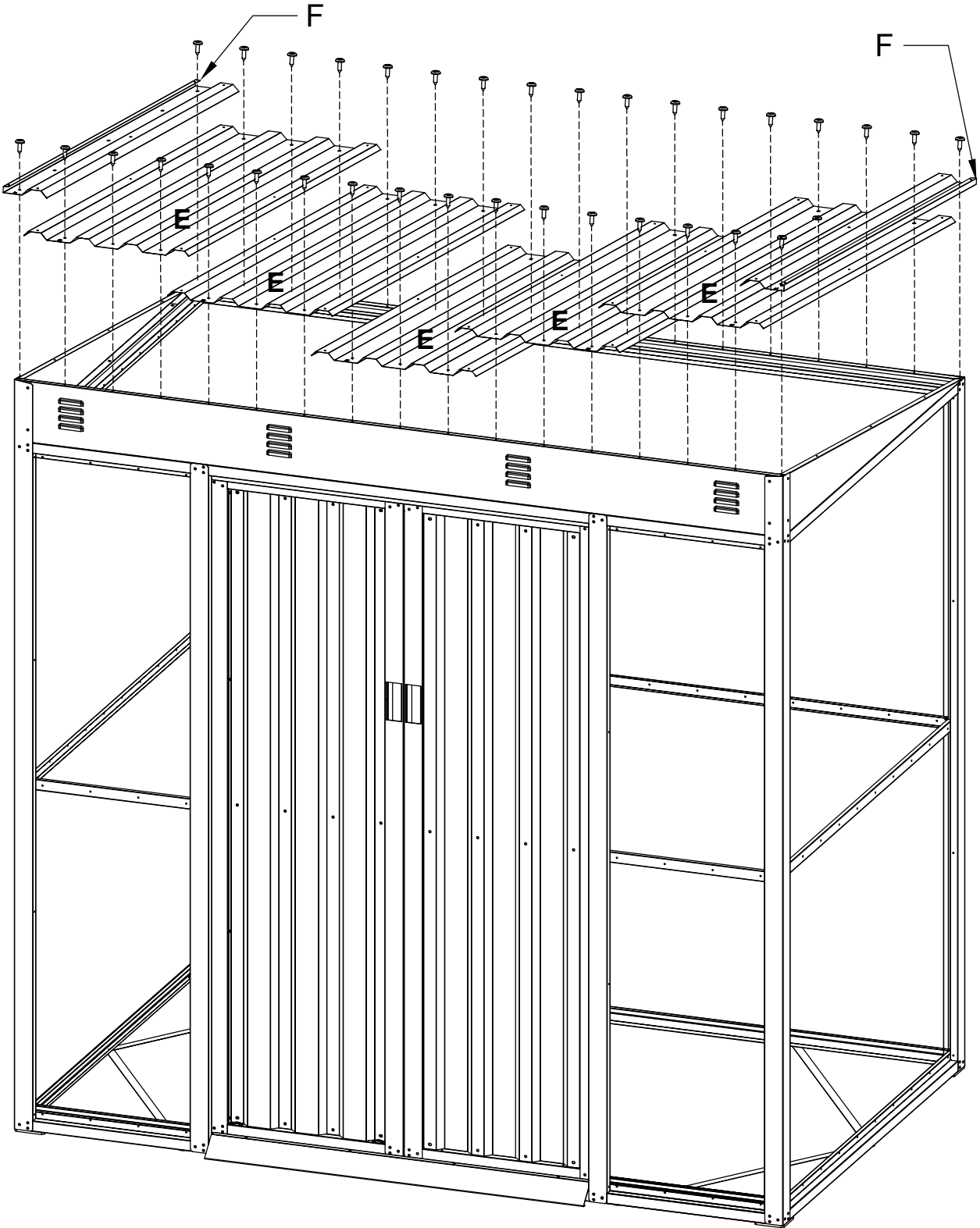

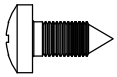
Y	 	34PCS
----------	---	--------------

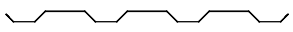
E	5PCS	
----------	-------------	---

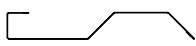
F	2PCS	
----------	-------------	---

Step 8: Install the front and rear of the top and seal the edges.

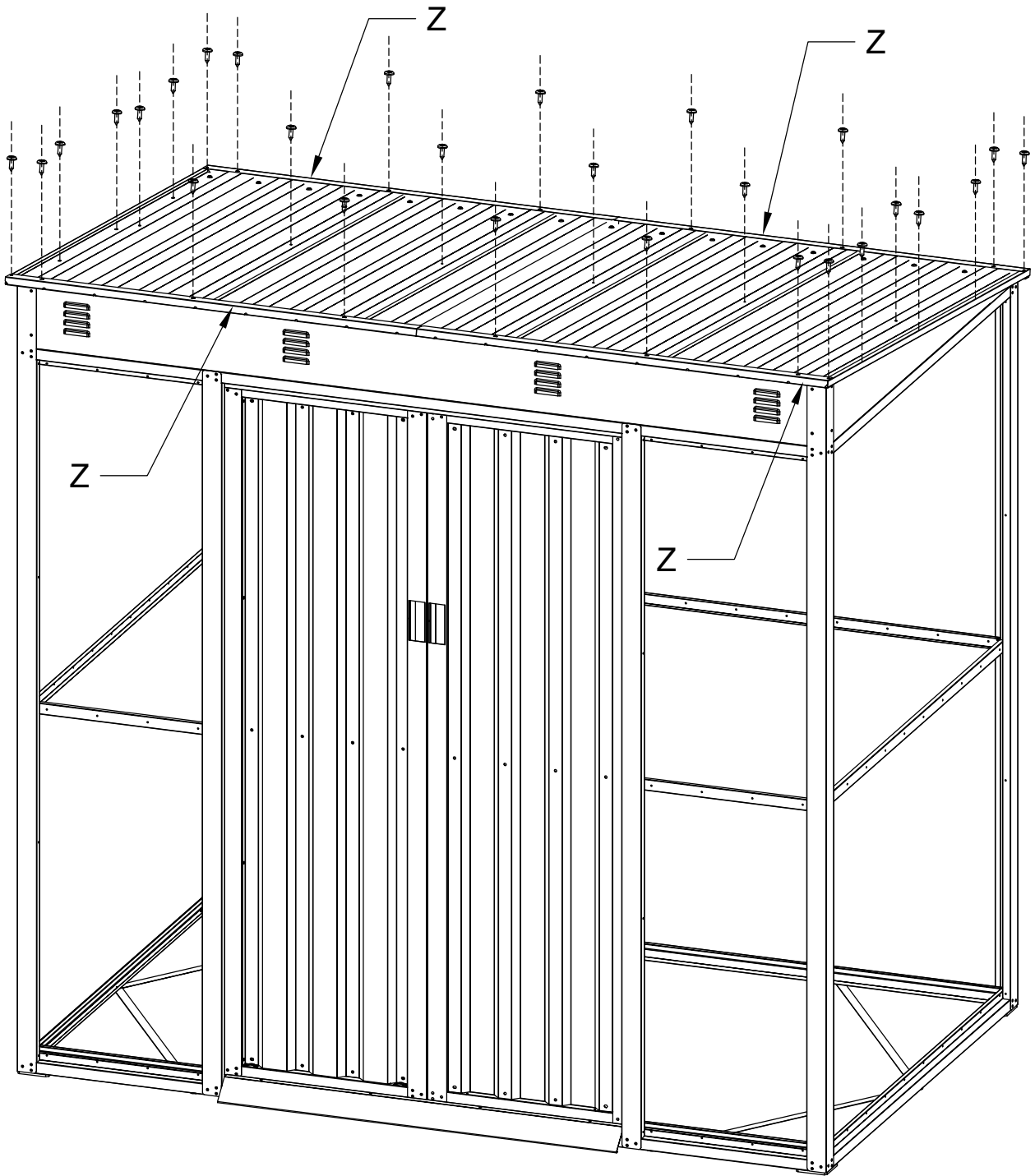

Y

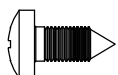

28PCS



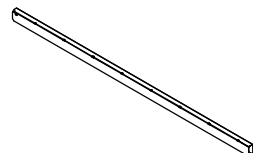

Z

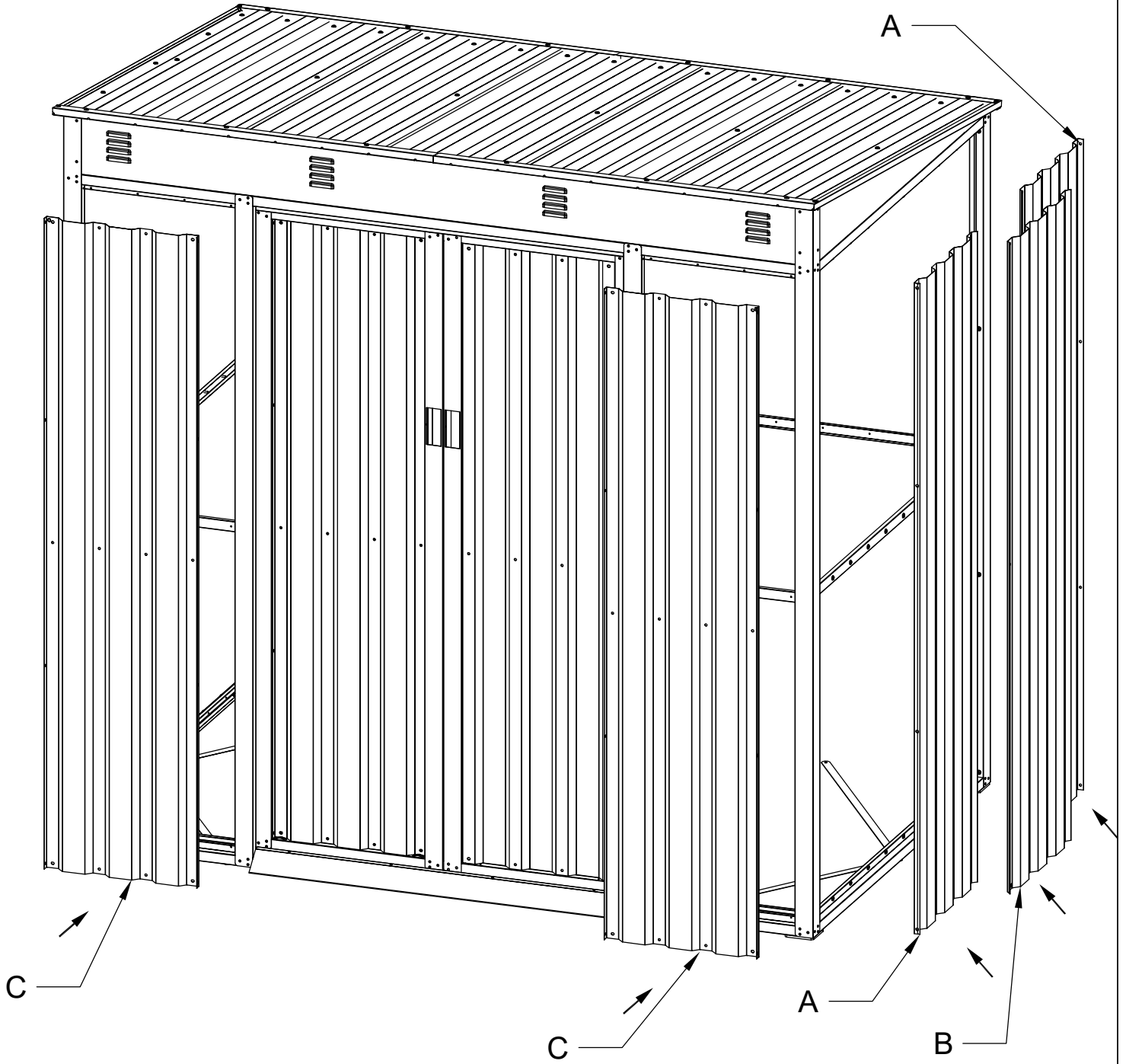

4PCS

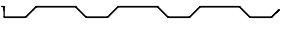

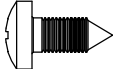
Step 9: Install corrugated board (A), (B) and (C), as shown in the picture.

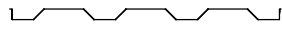

A	2PCS		Y			78PCS
B	1PCS					
C	2PCS					

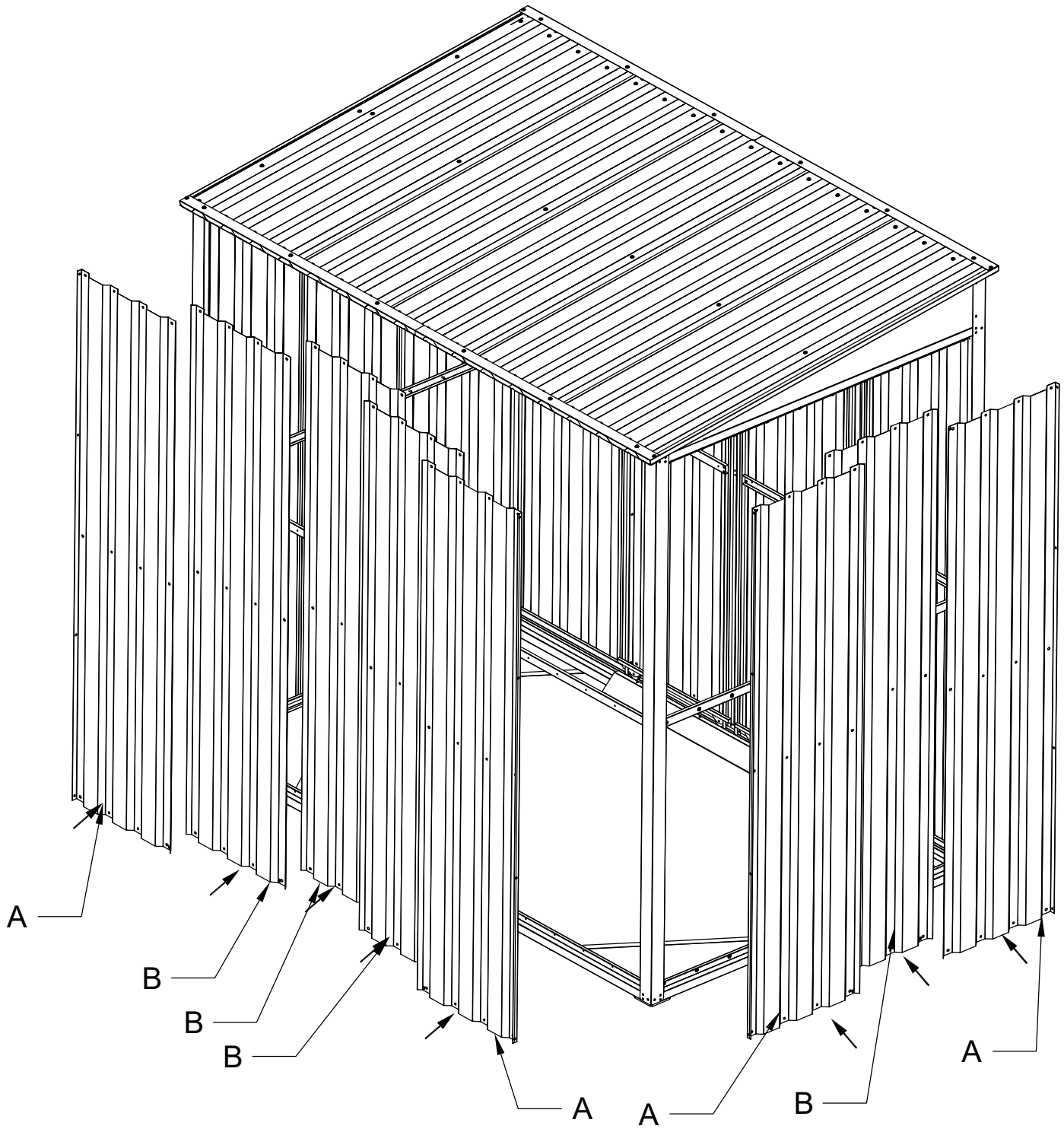
Step 10: Install corrugated board (A) and (B) , as shown in the picture.

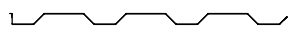

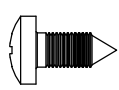
A	4PCS		Y			94PCS
B	4PCS	