

ASSEMBLY INSTRUCTIONS

ITEM DESCRIPTION

ITEM NUMBER: LAMR01-4555

NAME: **Retangular Mirror**

FINISH:

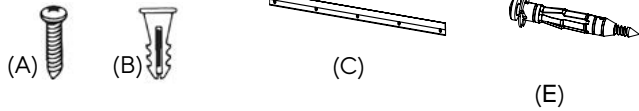

PARTS INCLUDED

- | | |
|--------------------|------------------------|
| (A) Round Screw | Qty: 10 |
| (B) Plastic Anchor | Qty: 10 |
| (C) Z-Bar | Qty: 4(2 Preinstalled) |
| (D) Mirror | Qty: 1 |
| (E) Molly Bolt | Qty: 10 |

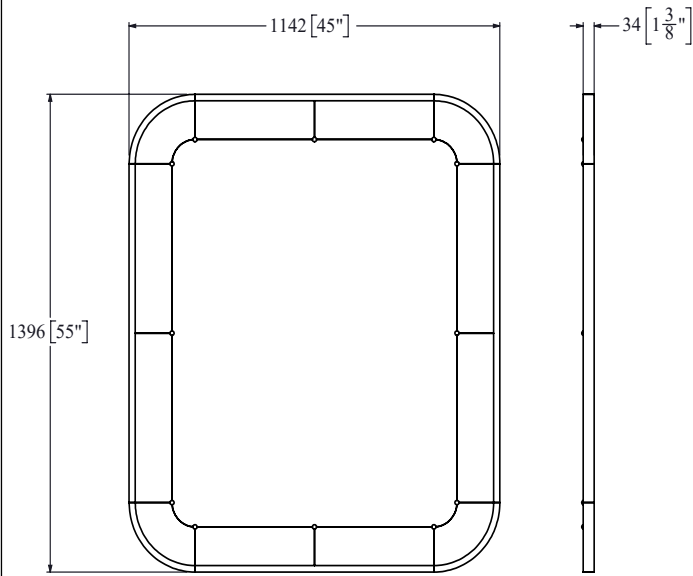

(D)

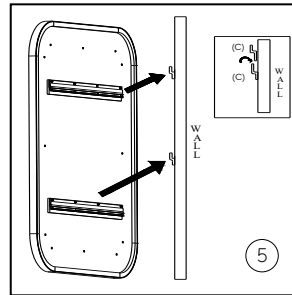
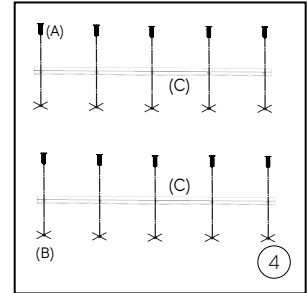
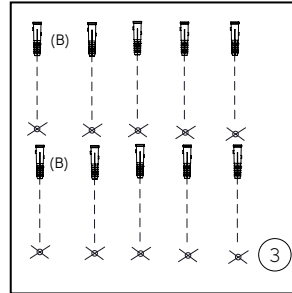
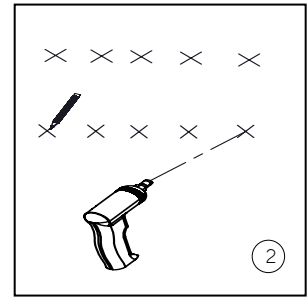
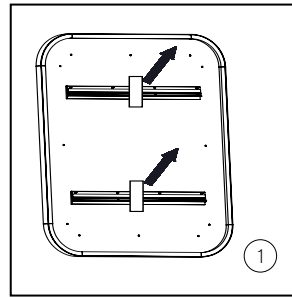

Refrain from disposing of packaging materials until the assembly is complete.

TO HANG

1. Remove the taped Z-Bar (C) from the back of the mirror. The Z-Bar hardware will be in the security bag if it is not taped to the back.
2. Mark the wall where the Z-Bar (C) will hang according to your desired orientation, and then drill two holes at the marked locations.
3. Firmly insert the anchors (B) into the drilled holes.
4. Position the Z-Bar (C) over the anchors (B) and secure it to the wall using the round screws (A).
5. Hang the mirror on the wall by interlocking the Z-Bars (C).

CARE INSTRUCTIONS

To maintain the beauty and integrity of your mirror, gently wipe it with a soft, dry cloth and avoid using harsh chemicals or household cleaners to protect the finish.

**WENDOVER
ART GROUP**

For customer service,
contact 888-743-9232 or
info@wendoverart.com.