

EN:

CAUTION:

- * Before using the chair, check to ensure that all screws are fully tightened.
- * Retighten all screws every 6 months or as needed.

To remove odor, air the chair outdoors in shade for 1-2 days.

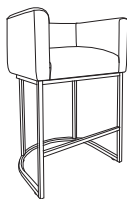

Periodically retighten all screws. Do not use an electric screwdriver.



ES:

PRECAUCIÓN:

- * Antes de usar la silla, Antes de usar la silla, compruebe que todos los tornillos estén completamente apretados.
- * Reapriete todos los tornillos cada 6 meses o cuando sea necesario.

Para eliminar el olor, airee la silla al aire libre, a la sombra, durante 1-2 días.

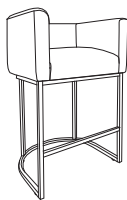

Reapriete periódicamente todos los tornillos. No utilice un atornillador eléctrico.



FR:

ATTENTION :

- * Avant d'utiliser la chaise, assurez-vous que tous les vis sont complètement serrés.
- * Resserrez toutes les vis tous les 6 mois ou selon les besoins.

Pour éliminer les odeurs, aérez la chaise à l'extérieur à l'ombre pendant 1 à 2 jours.

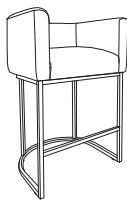

Resserrez périodiquement toutes les vis. N'utilisez pas de tournevis électrique.



Safety Information / Información de seguridad / Informations Relatives à la Sécurité



**INSTRUCTION MANUAL
MANUAL DE INSTRUCCIONES
MANUEL D'INSTRUCTIONS
FK-BYV16TX-27**

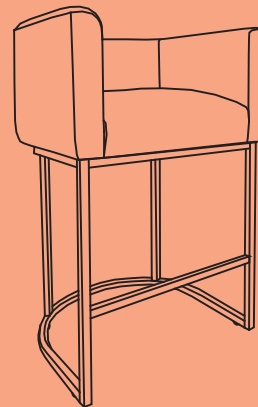

✉ HJ-Customer-Service@outlook.com

☎ 6269443420 | 6267435564

EST 9:00AM-17:00PM

✉ HJ-Customer-Service@outlook.com

☎ 6269443420 | 6267435564

9:00-17:00 h (EST)

✉ HJ-Customer-Service@outlook.com

☎ 6269443420 | 6267435564

9h00-17h00 HNE

A x1

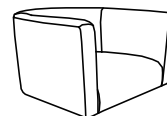

B x1



C x1



D x2



E x1

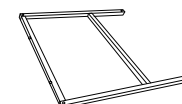

1 x8



M8x35mm

2 x3



M6x20mm

3 x2



M6x40mm

4 x1





EN:  : Partially tighten the screws.

 : Fully tighten the screws.

ES:  : Apriete parcialmente los tornillos.

 : Apriete completamente los tornillos.

FR:  : Serrez d'abord les vis partiellement.

 : Serrez les vis complètement.

EN: **Note:** Mounting tabs facing up.
ES: **Nota:** Las pestañas de montaje deben quedar orientadas hacia arriba.
FR: **Remarque:** Les pattes de fixation doivent être orientées vers le haut.

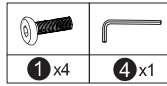

1

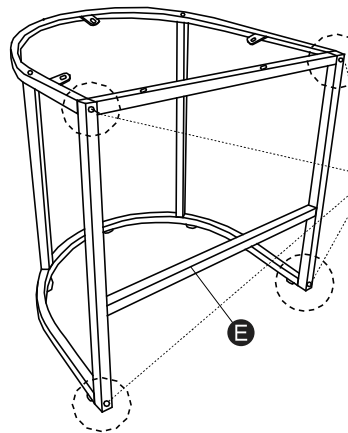

2

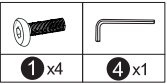

4

EN: Fully tighten all screws.
ES: Asegúrese de apretarlos firmemente.
FR: Serrez toutes les vis complètement.

3

