





# ASSEMBLY INSTRUCTION

## 3 PCS X BACK KIDS - TABLE

PARTS LIST				HARDWARE LIST			
NO	DESCRIPTION		QTY	NO	DESCRIPTION	QTY	
1	TABLE TOP		1	A	JCBC SCREW (M6 X 60mm)		8
				B	SPRING WASHER (1/4"mm)		8
2	TABLE LEG		4	C	FLAT WASHER (1/4"mm)		8
				D	ALLEN WRENCH (M4)		1

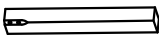
**STEP 1 :** Place the table top(1) upside down on protected surface and attach table leg(2) to the corner of apron by using flat washer(C), spring washer(B) and JCBC screw(A). Tighten with Allen wrench(D) as shown.

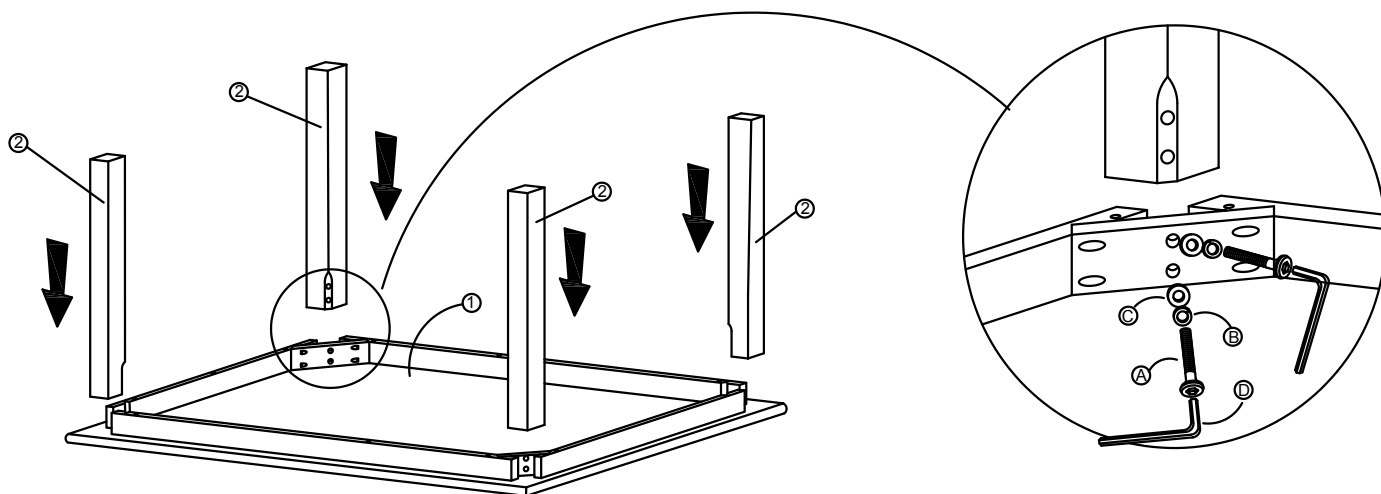

**STEP 2 :** The table is ready for using.

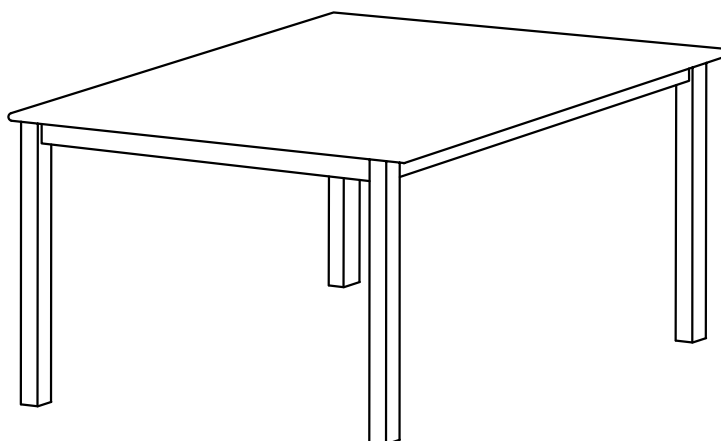

**IMPORTANT NOTE :**

- \*\*\*PLACE ALL WOODEN PARTS ON A CLEAN AND SMOOTH SURFACE SUCH AS A RUG OR CARPET TO AVOID SCRATHING THE PARTS.
- \*\*\*KINDLY FOLLOW THE ASSEMBLY INSTRUCTION STEP BY STEP.
- \*\*\*WE RECOMMEND THAT YOU SAVE THE ALLEN WRENCH (PART A) AND PERIODICALLY TIGHTEN ALL BOLTS/SCREWS. PLEASE MAKE SURE ALL BOLTS/SCREWS ARE PLACED IN THEIR PROPER POSITION AND ARE TIGHTENED SECURELY TO ENSURE YOUR SAFETY.
- \*\*\*DO NOT STAND OR CLIMB ON THE CHAIR.
- \*\*\*WEIGHT RESTRICTION: 100LBS.
- \*\*\*NOT FOR COMMERCIAL USE.