

ASSEMBLY INSTRUCTIONS

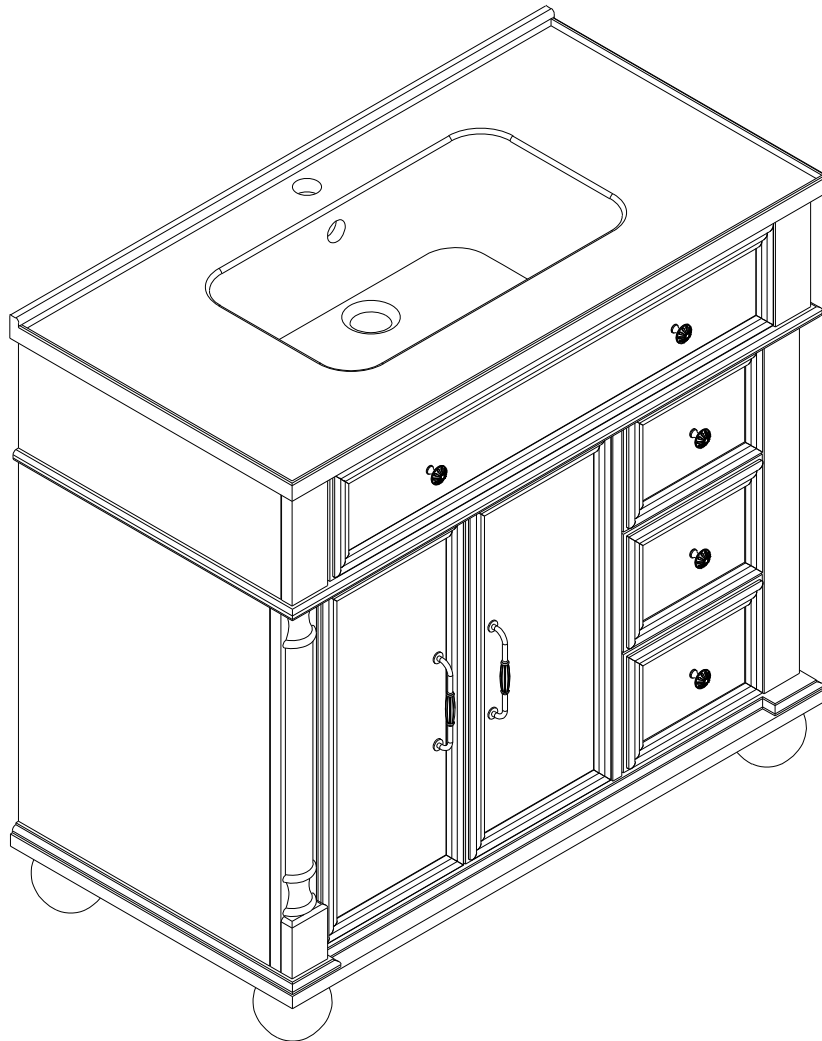

Notice:

1. Follow the installation instructions. Please confirm all accessories are preset before installation.
2. Do not fully tighten the screws during initial assembly. Fully tighten screws only once all pieces which are correctly assembled.
3. If you encounter any problems during installation, please contact our customer service.
4. Please unbox the item from the side with an open-label and put a carpet on the floor to avoid scratching it.

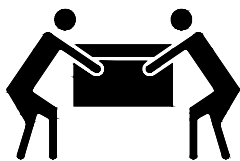

Recommended installers:2

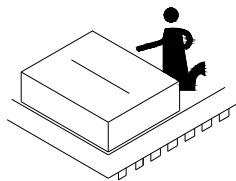

Put a carpet on the floor
before unpacking

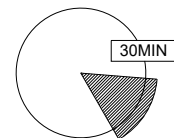

Estimate installation time:
30minutes

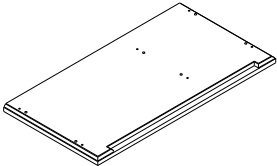
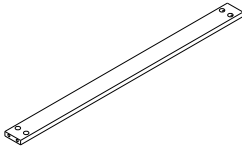
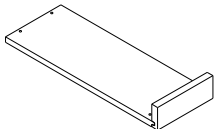
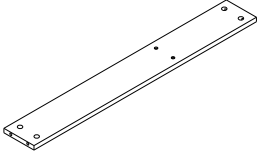
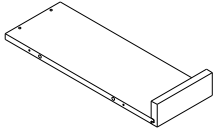
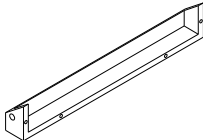
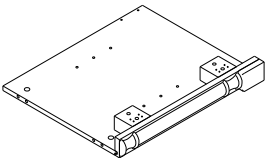
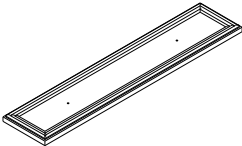
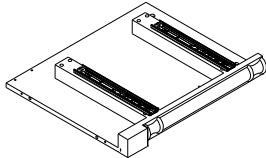
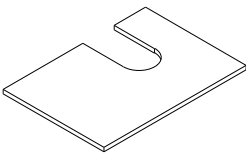
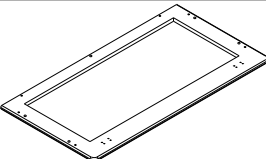
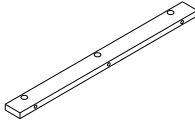
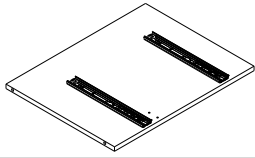
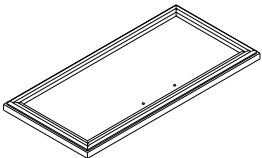
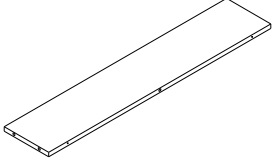
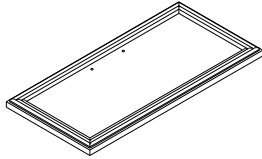

ASSEMBLY INSTRUCTIONS

PART LIST

Item no.	Reference Image	Qty	Item no.	Reference Image	Qty
(A)		X1	(I)		X1
(B)		X1	(J)		X1
(C)		X1	(K)		X1
(D)		X1	(L)		X1
(E)		X1	(M)		X1
(F)		X1	(N)		X1
(G)		X1	(O)		X1
(H)		X1	(P)		X1



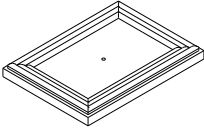
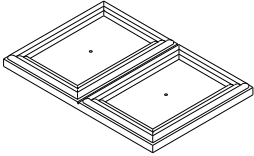
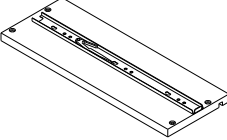
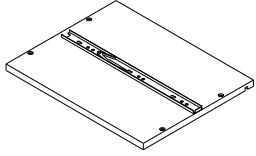
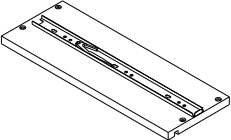
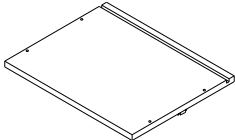
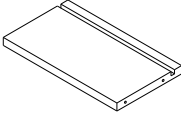
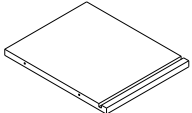
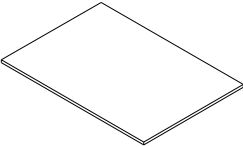
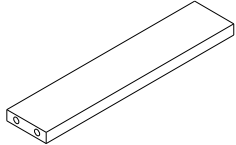







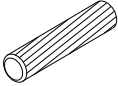
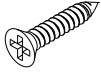

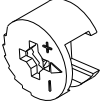
ASSEMBLY INSTRUCTIONS

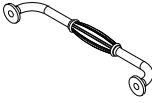
PART LIST

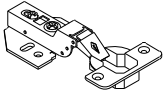
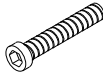
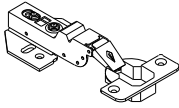
Item no.	Reference Image	Qty	Item no.	Reference Image	Qty
Q		X1	V		X1
R		X1	W		X1
S		X1	X		X1
T		X1	Y		X1
U		X2	Z		X1
			ZZ		X4

ASSEMBLY INSTRUCTIONS

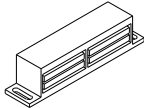
HARDWARE LIST

Item no.	Reference Image	Qty	Item no.	Reference Image	Qty
1	 Ø8*30mm	X15+1	10	 Ø3*16mm	X2
2		X29+2	11		X4
3		X29+2	12		X5
4	 Ø3.5*50mm	X16+1	13		X2
5	 Ø3.5*30mm	X18+1	14	 Ø5*3/4"	X9
6		X4	15	 Ø1/4"*2"	X4
7		X2	16		X4
8	 Ø3*14mm	X36+3	17	 Ø1/4"*1.0T*D12mm	X4
9		X1	18		X1

ASSEMBLY INSTRUCTIONS

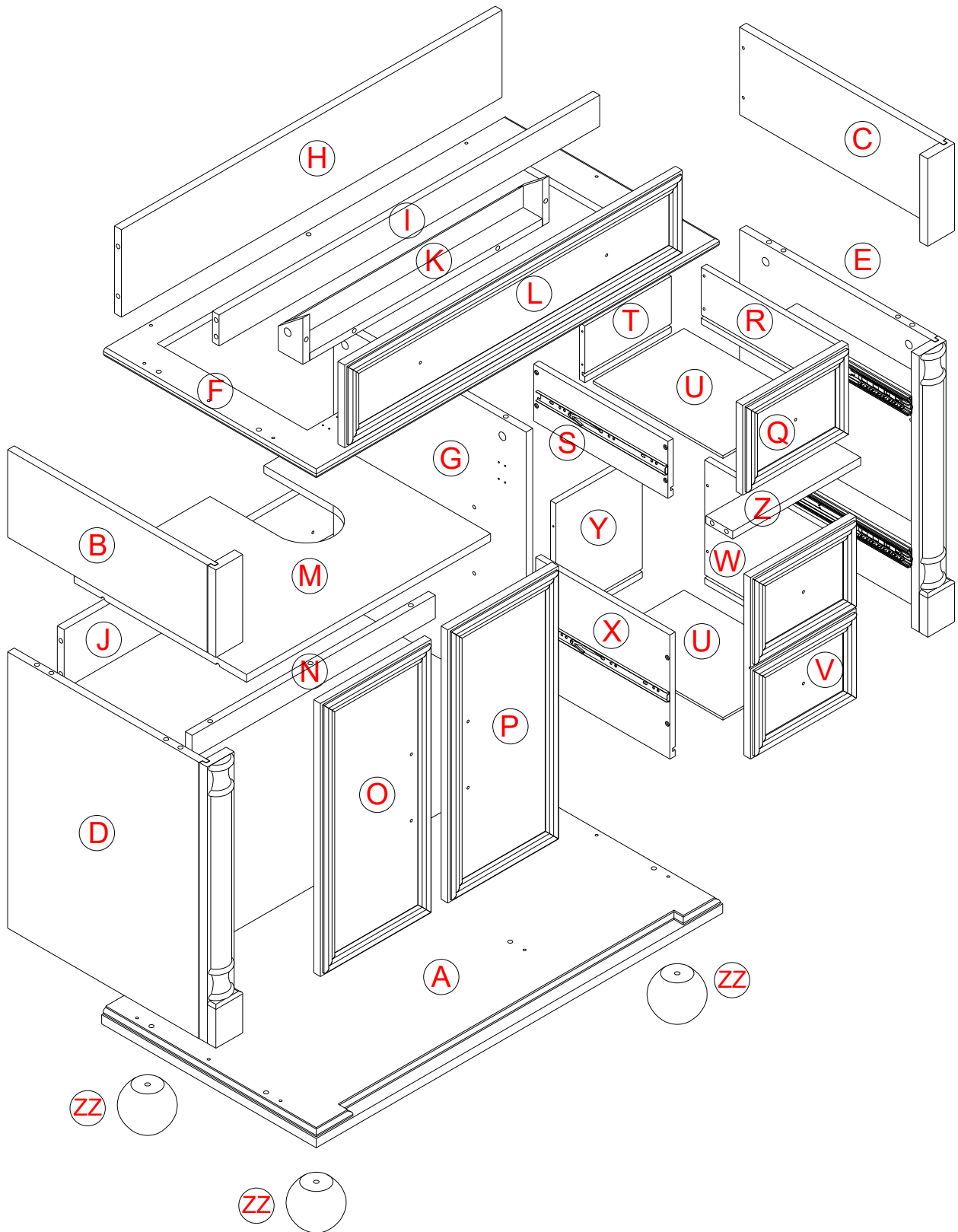

ASSEMBLY INSTRUCTIONS

1

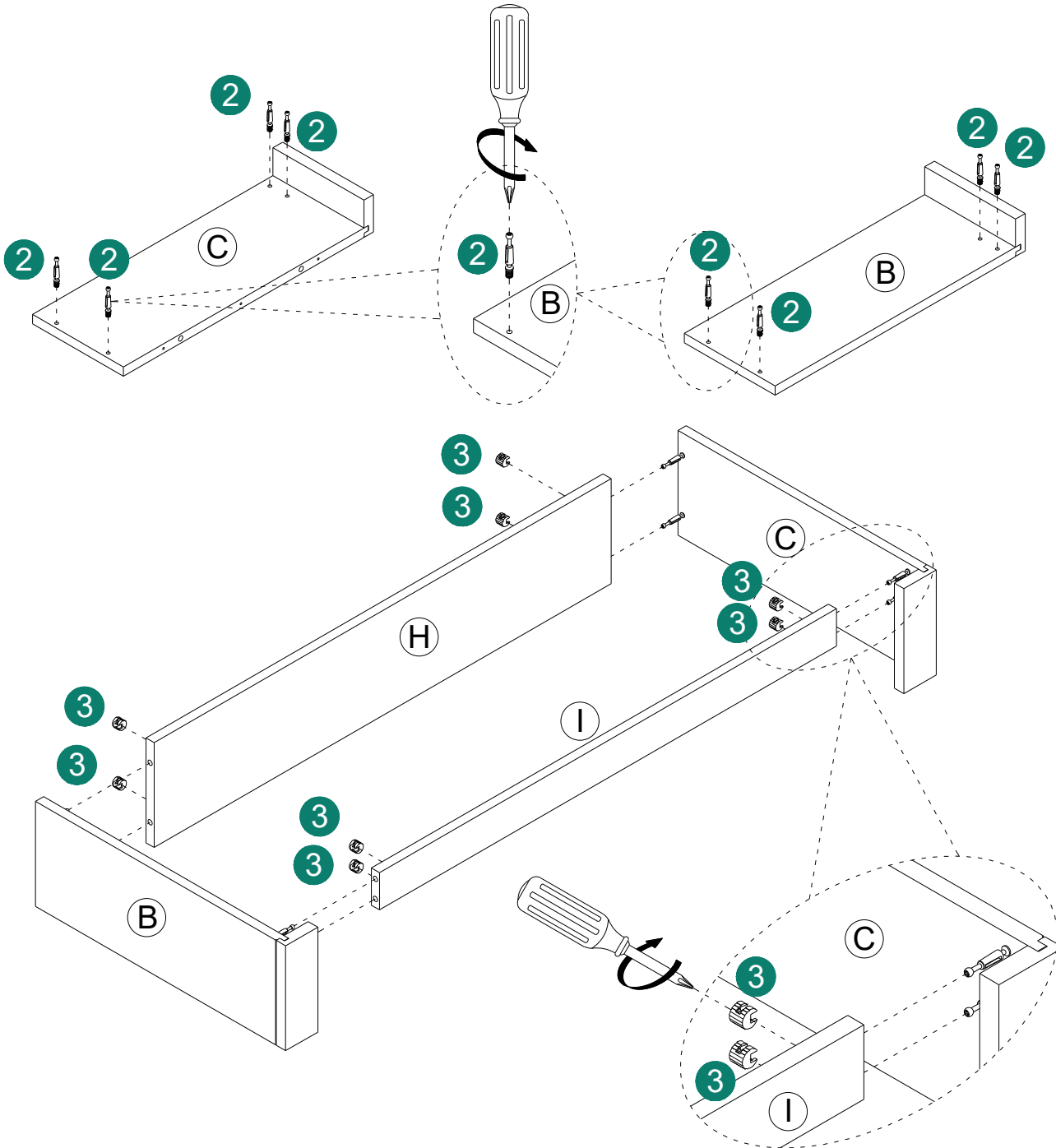
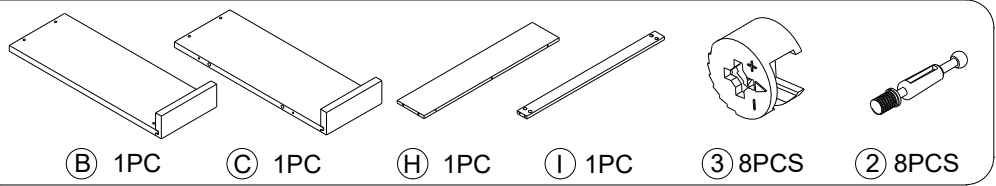

ASSEMBLY INSTRUCTIONS

2

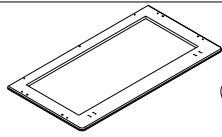

(F) 1PC



Ø3.5*50mm
(4) 8PCS

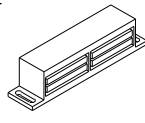

(9) 1PCS



Ø3*16mm
(10) 2PCS

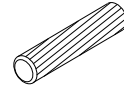

(1) 5PCS



(2) 6PCS

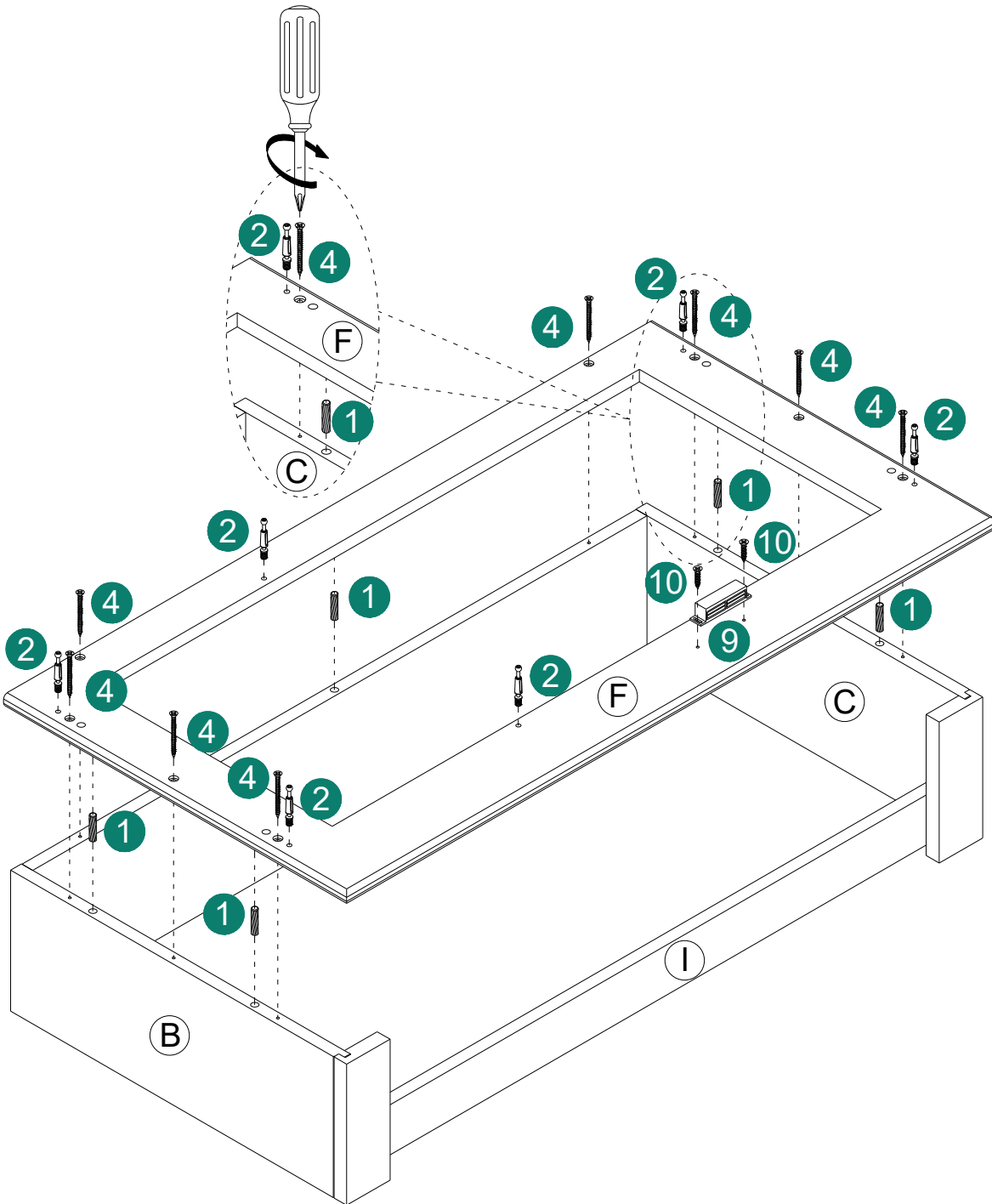

ASSEMBLY INSTRUCTIONS

3

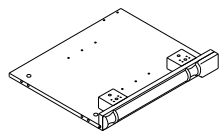

D 1PC

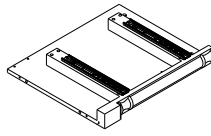

E 1PC

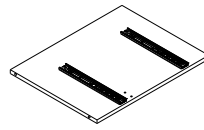

G 1PC



2 8PCS

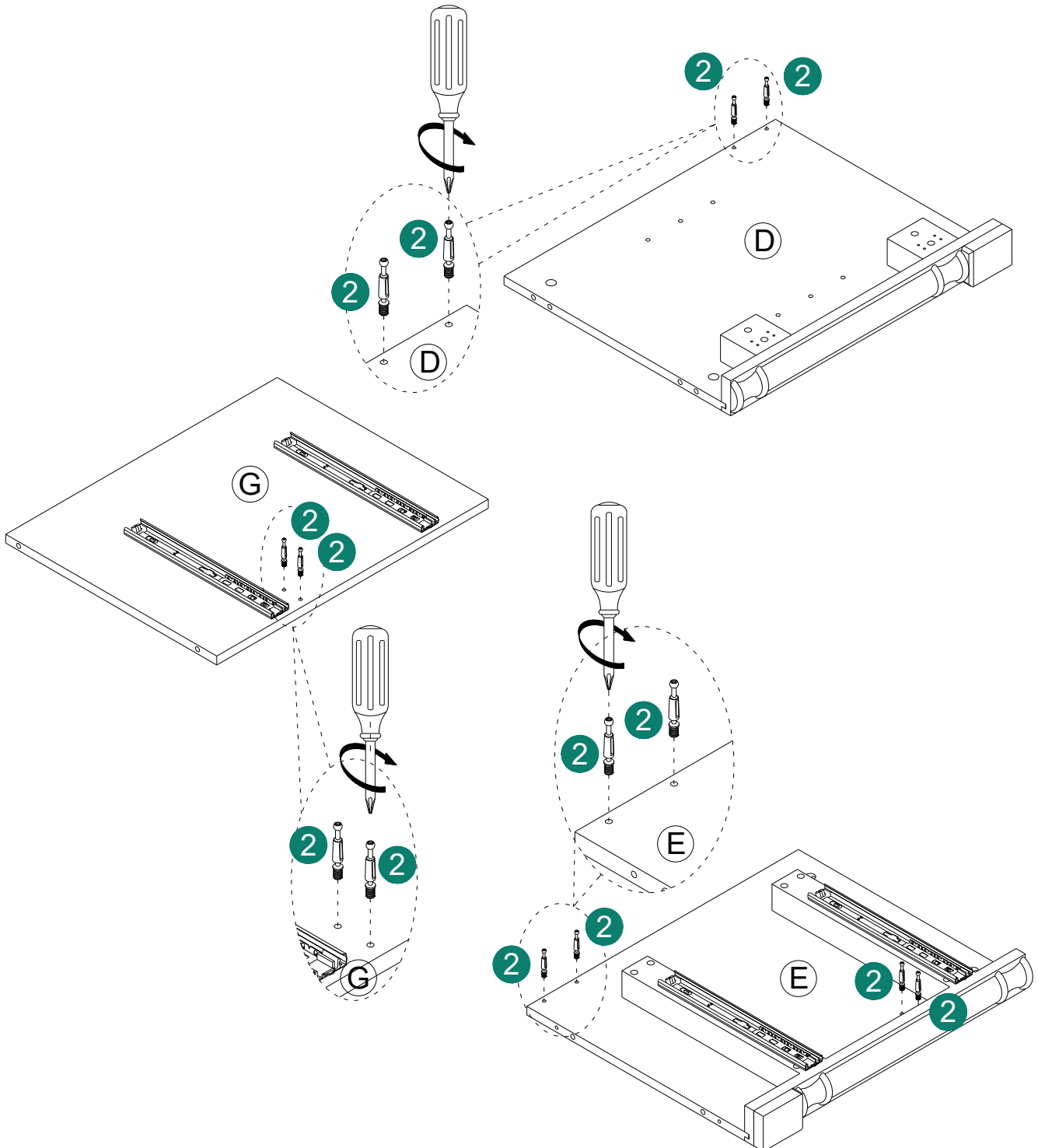

ASSEMBLY INSTRUCTIONS

4

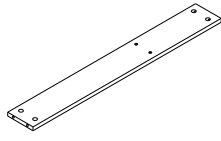

ⓐ 1PC

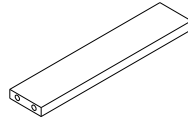

ⓑ 1PC

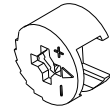

ⓒ 8PCS

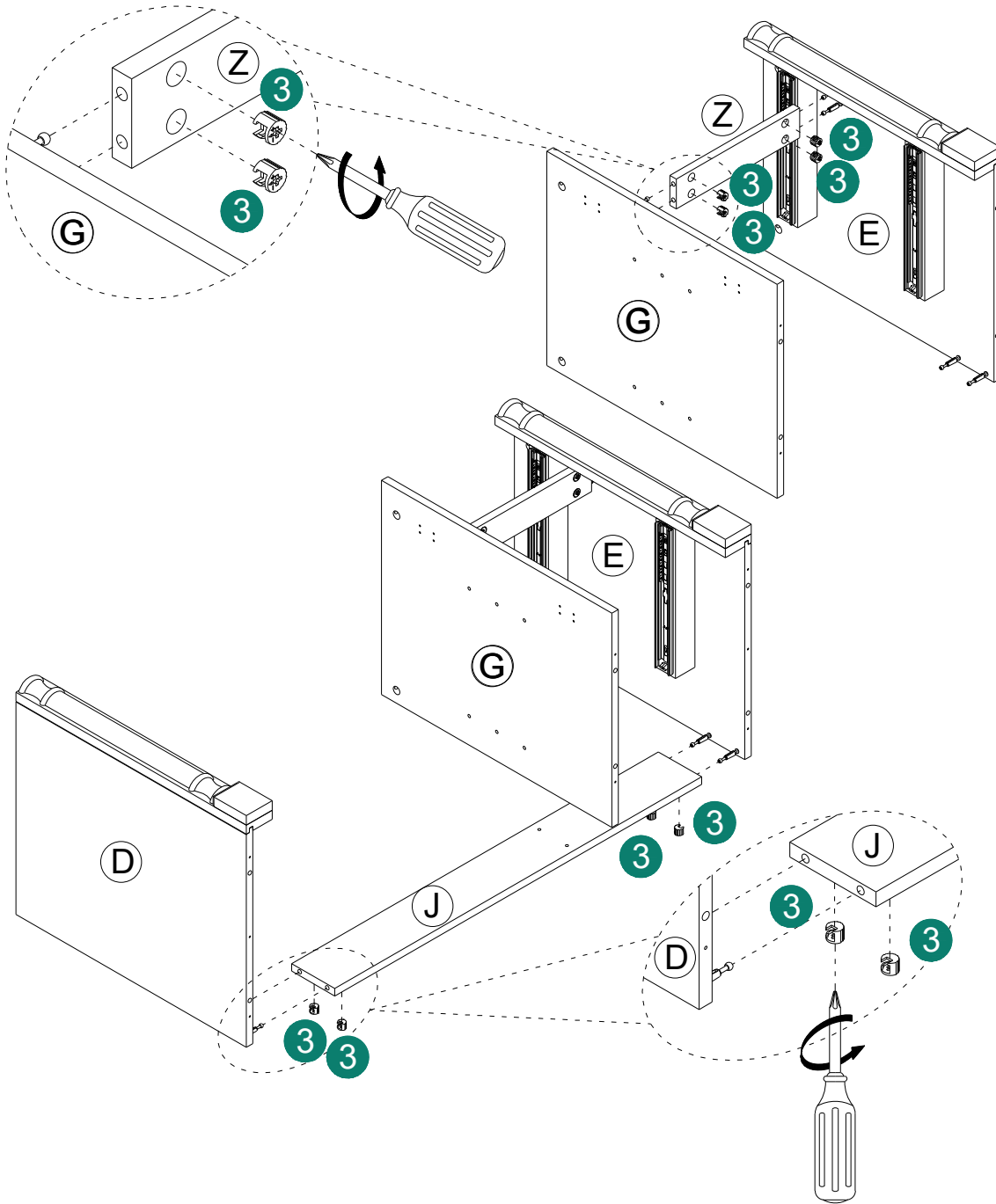

ASSEMBLY INSTRUCTIONS

5

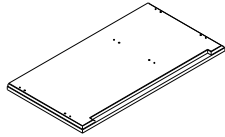

(A) 1PC



Ø3.5*50mm

(4) 8PCS

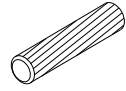

(1) 6PCS

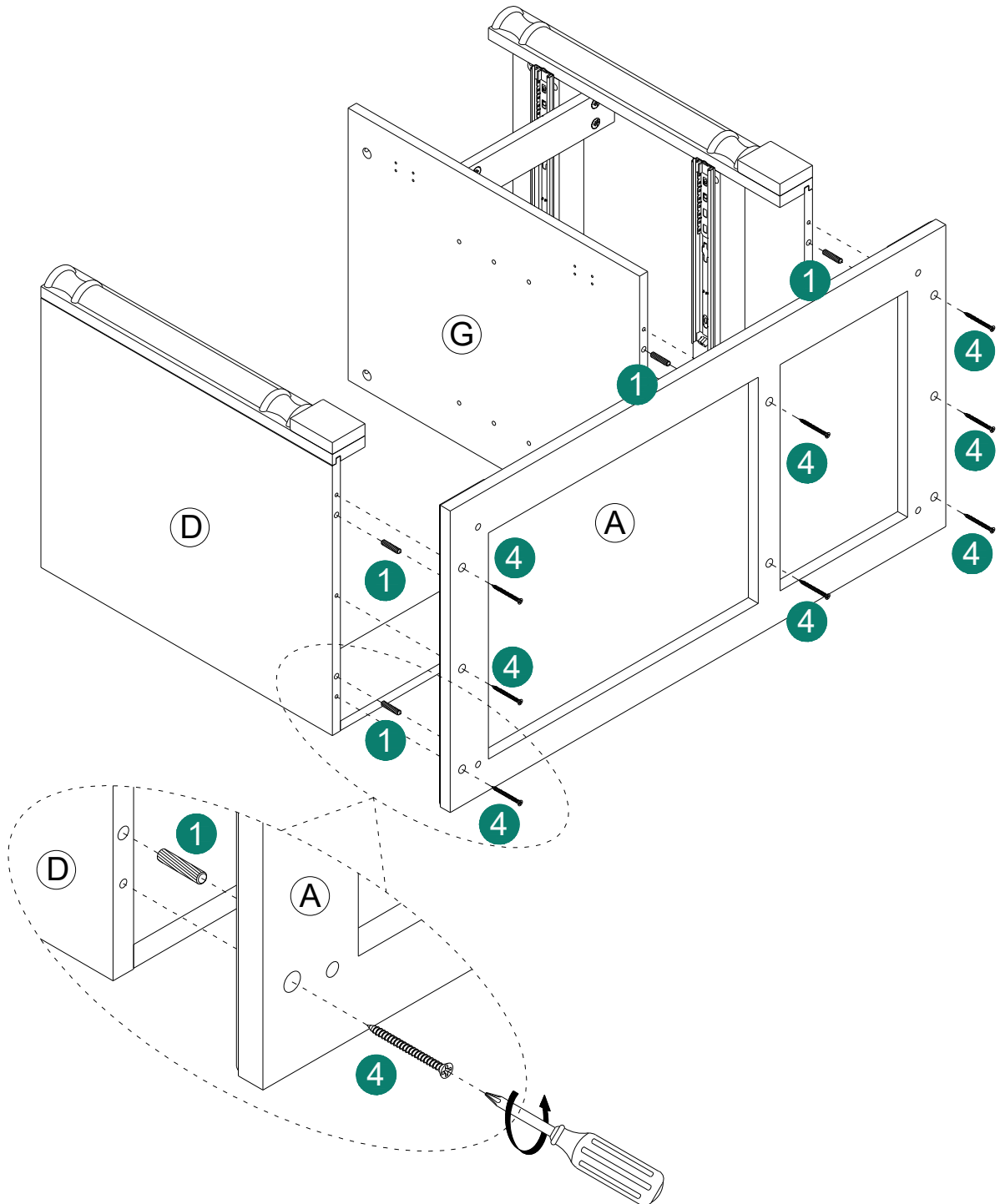

ASSEMBLY INSTRUCTIONS

6



ZZ 4PC

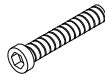

Ø1/4"*2"

15 4PCS



16 4PCS



17 4PCS



18 1PCS

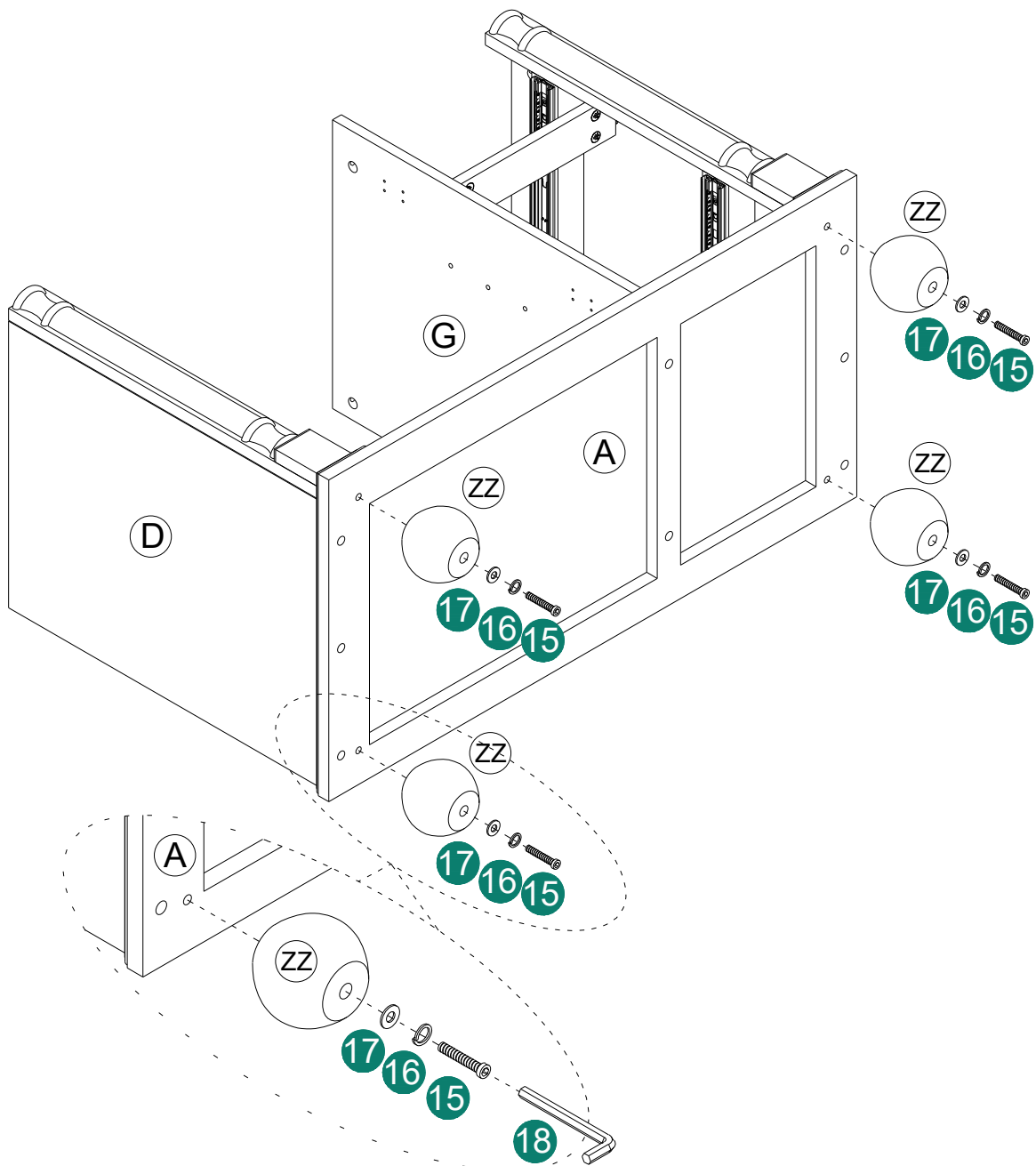

ASSEMBLY INSTRUCTIONS

7

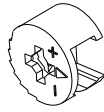

③ 6PCS

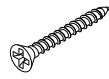

Ø3.5*30mm

⑤ 2PCS

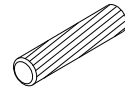

① 4PCS

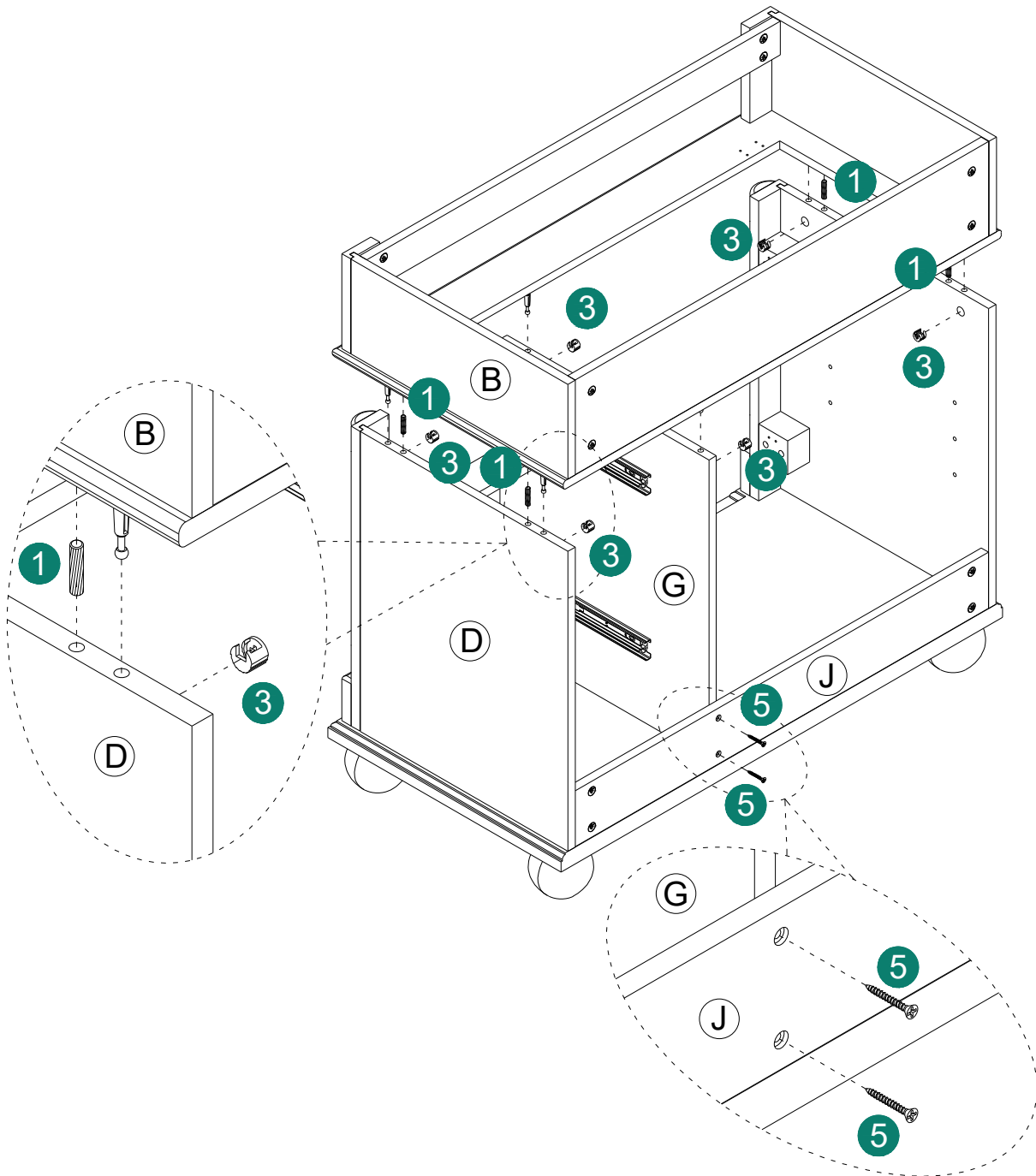

ASSEMBLY INSTRUCTIONS

8

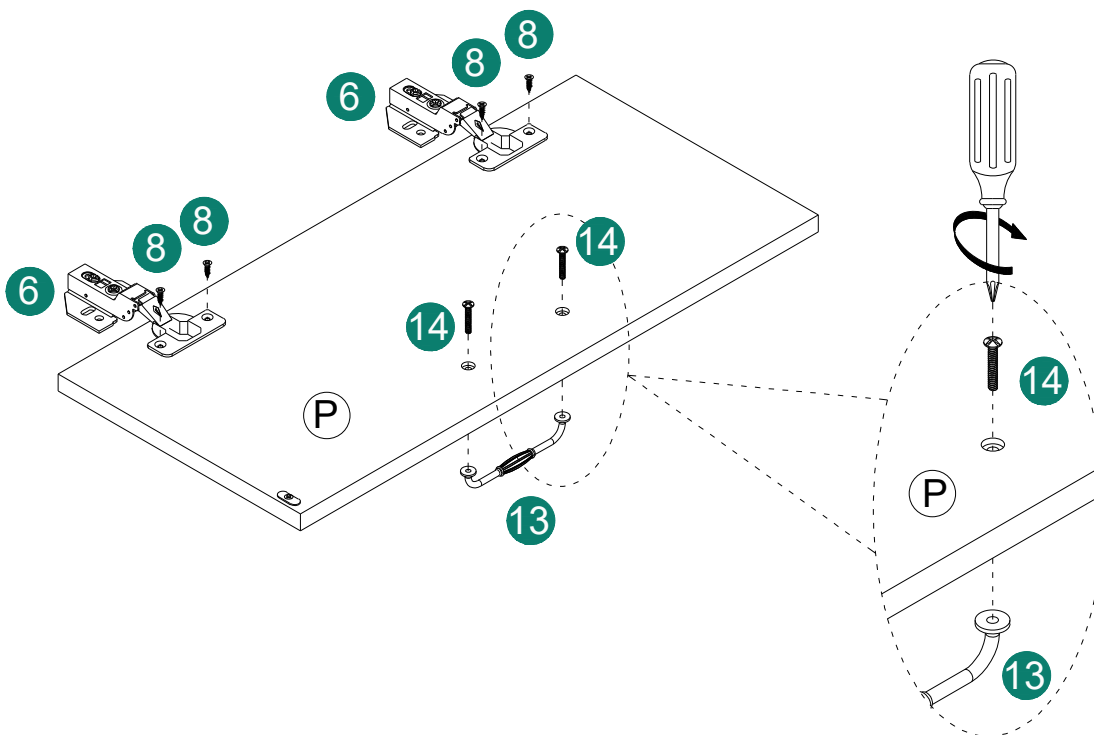
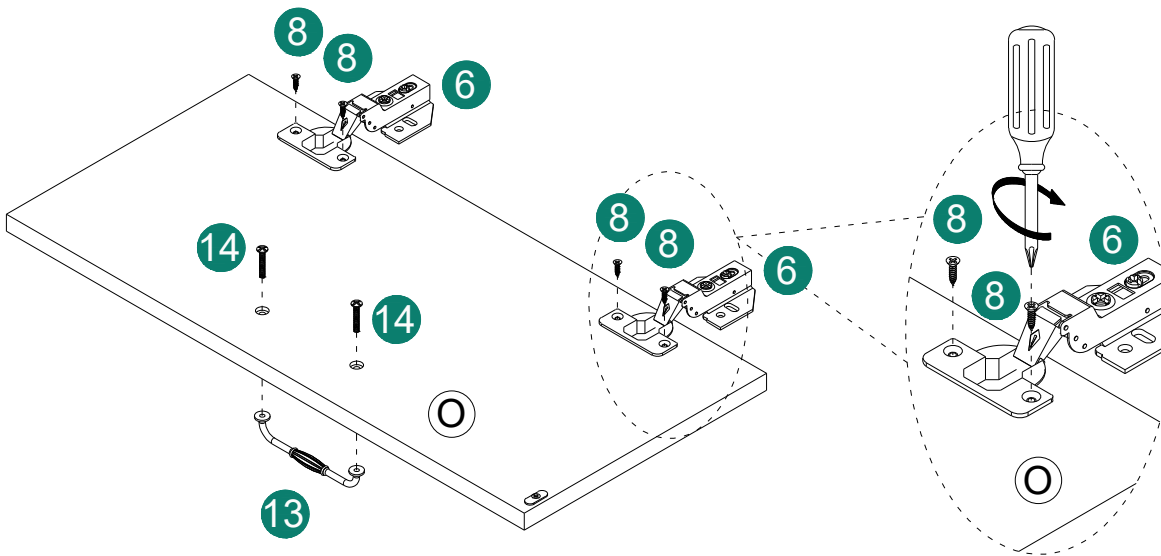
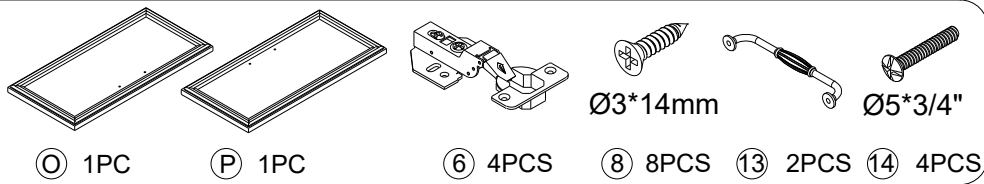

ASSEMBLY INSTRUCTIONS

9

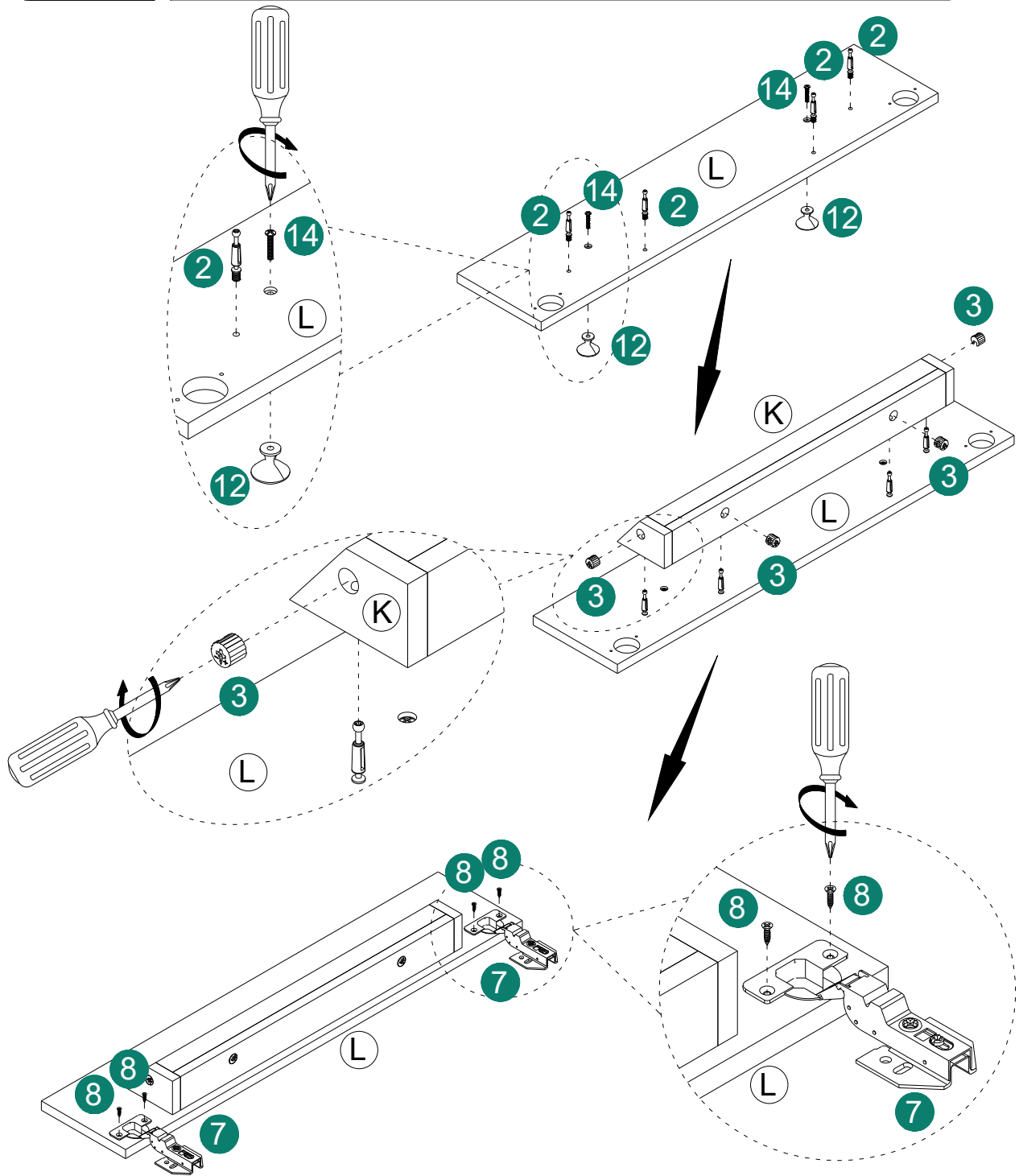
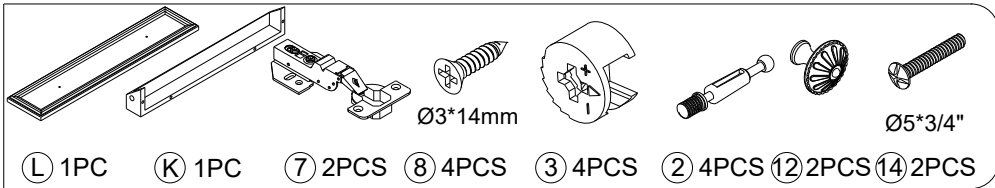

ASSEMBLY INSTRUCTIONS

10



⑧ 24PCS



⑪ 4PCS

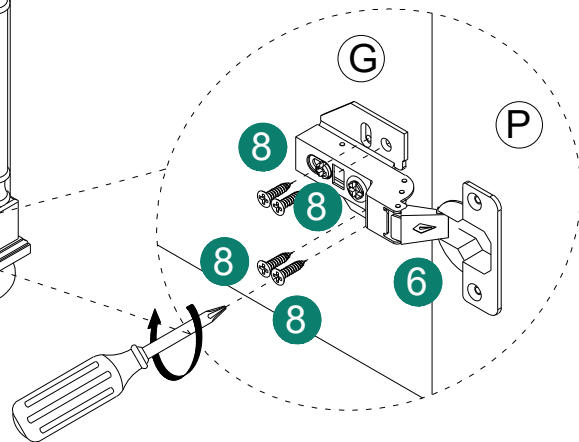
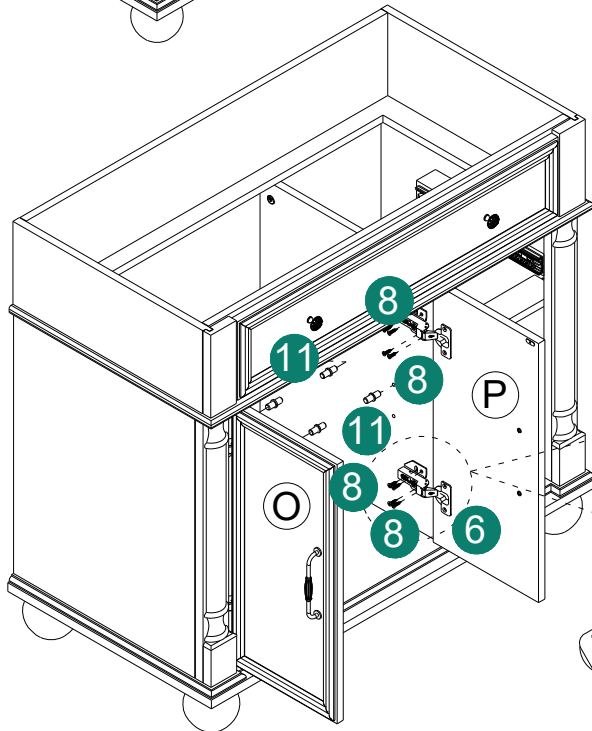
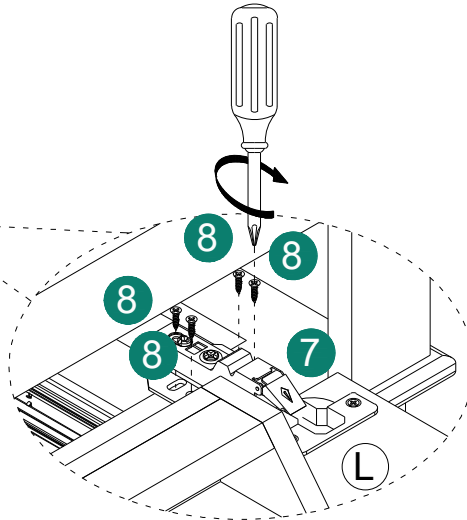
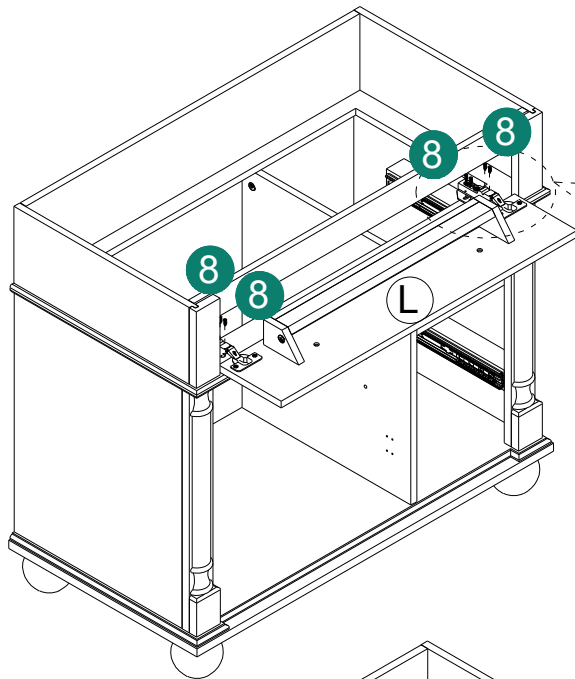

ASSEMBLY INSTRUCTIONS

9

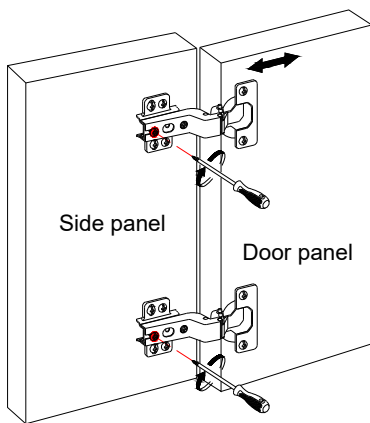

①

Front-to-Back Direction Adjustment:

Rotate the screws on the door hinges shown in the image. The door panel can be moved front-back.

Adjustment range: 4mm

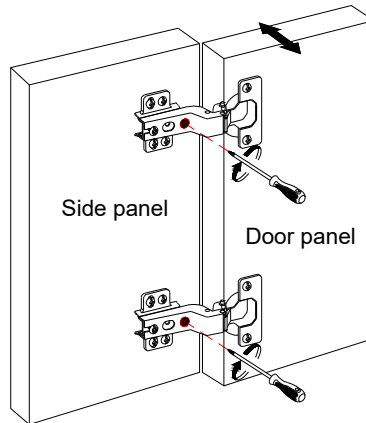

②

Left-Right Direction Adjustment:

Rotate the screws on the door hinges shown in the image. The door panel can be moved left-right.

Adjustment range: 3mm

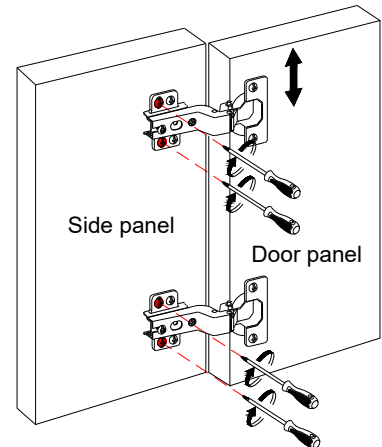

③

Up-Down Direction Adjustment:

Rotate the screws on the door hinges shown in the image. The door panel can be moved up-down.

Adjustment range: 4mm

ASSEMBLY INSTRUCTIONS

10

Common Door Panel Issues:

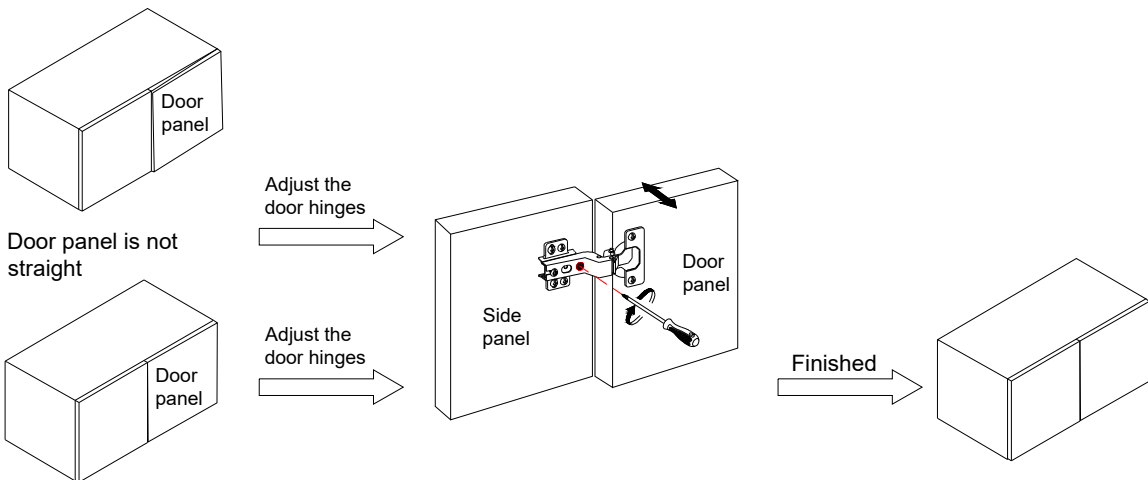

The gap between door panels is too large

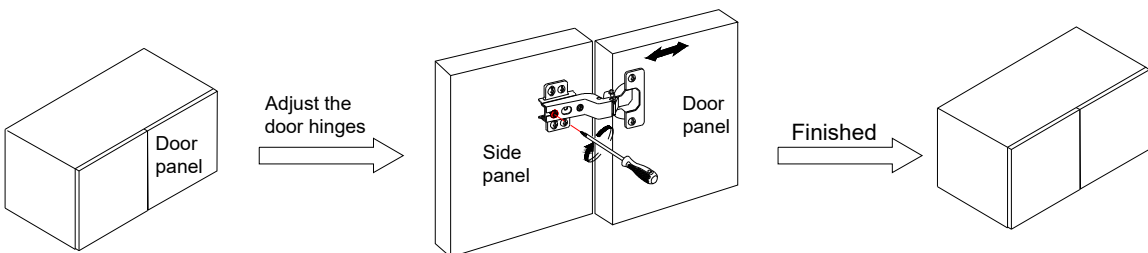

The door panels are not coplanar

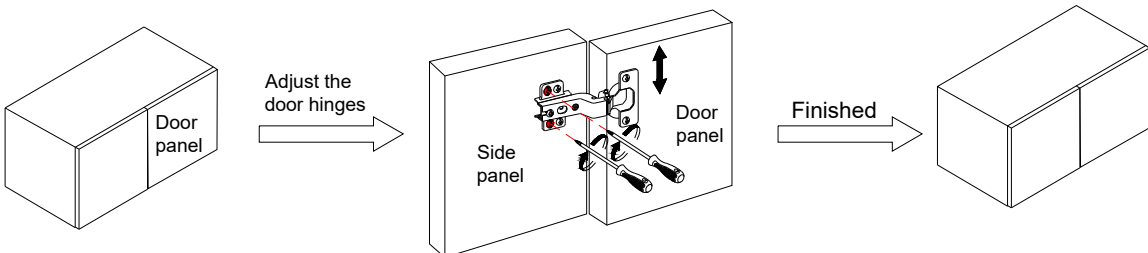

The two door panels are not at the same height

ASSEMBLY INSTRUCTIONS

11

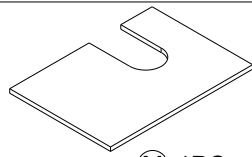

(M) 1PC

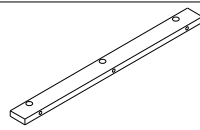

(N) 1PC

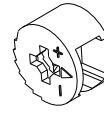

(3) 3PCS



(2) 3PCS

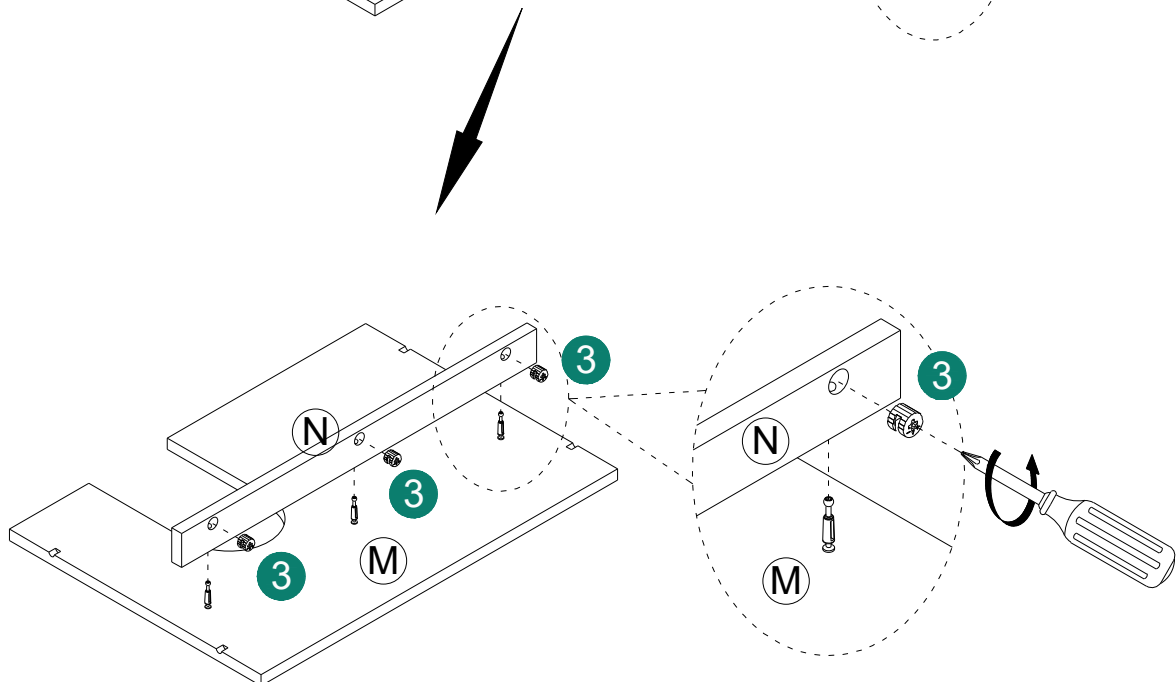
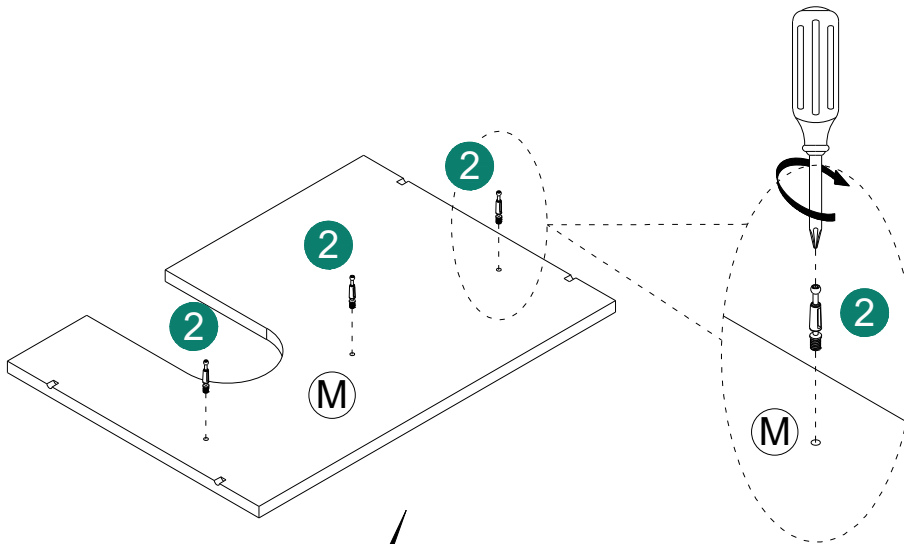

ASSEMBLY INSTRUCTIONS

12

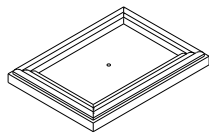

Q 1PC

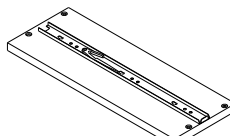

R 1PC

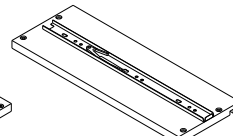

S 1PC

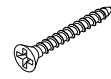

Ø3.5*30mm

5 4PCS

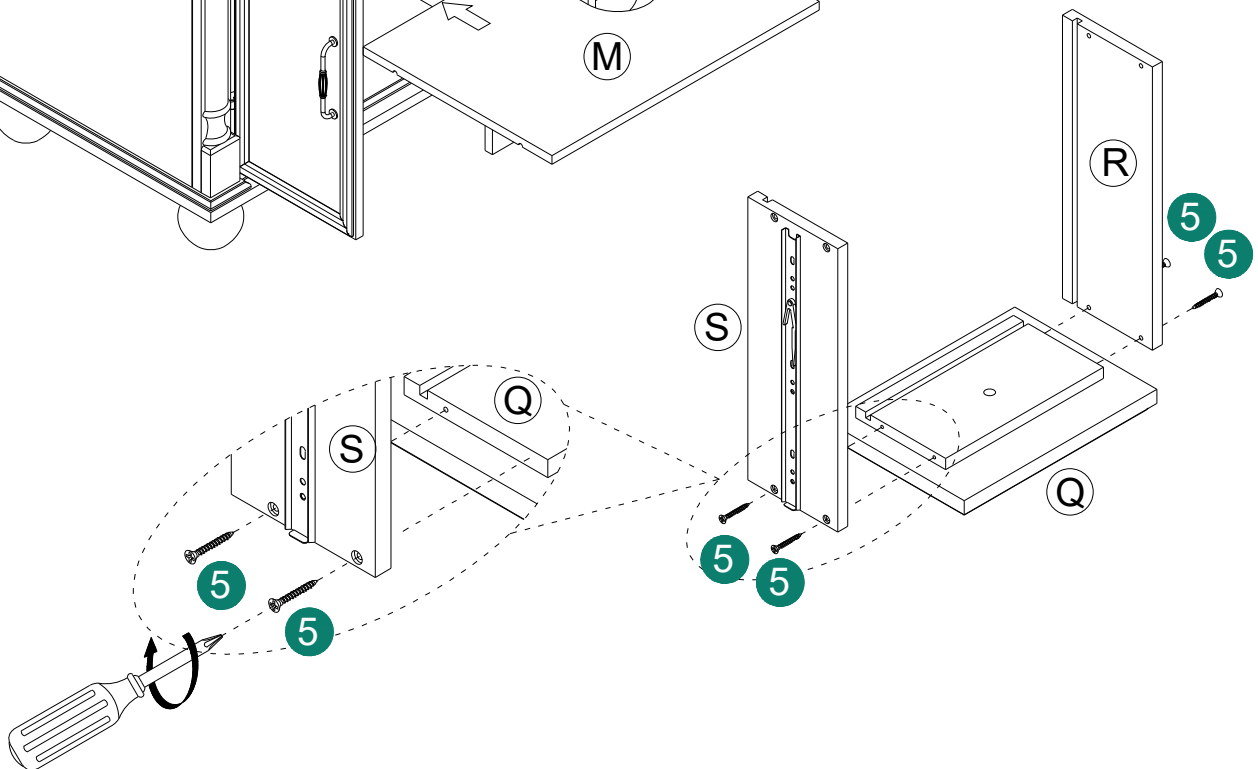
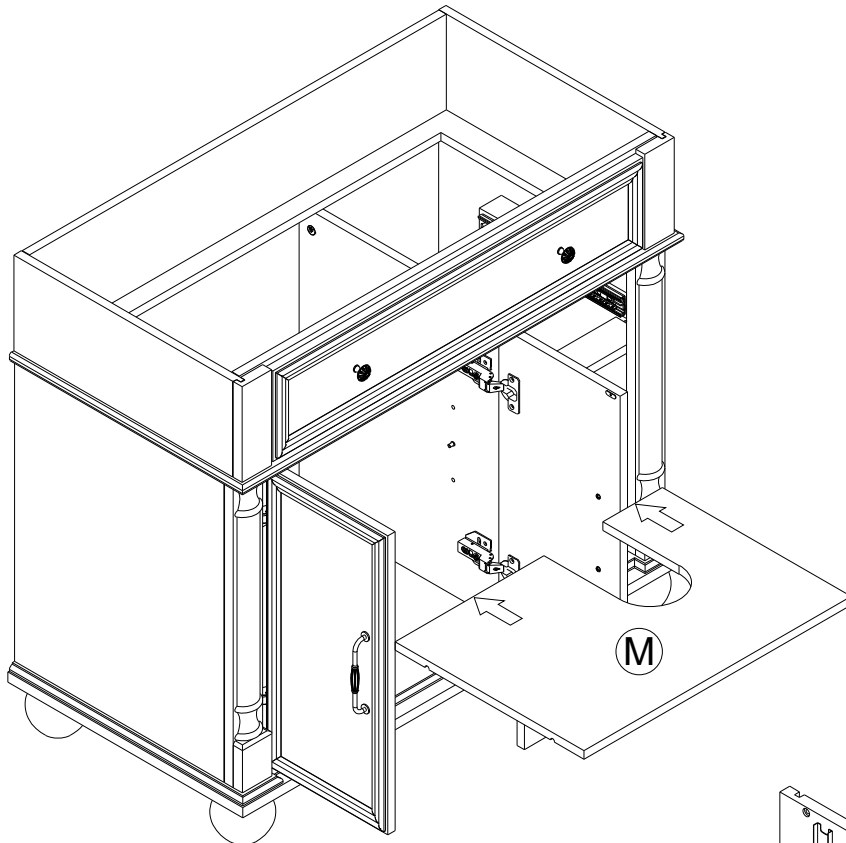

ASSEMBLY INSTRUCTIONS

13

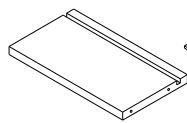

Ⓣ 1PC

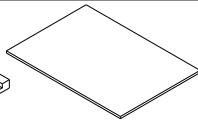

Ⓤ 1PC

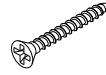

Ø3.5*30mm

⑤ 4PCS



⑫ 1PCS



Ø5*3/4"

⑭ 1PCS

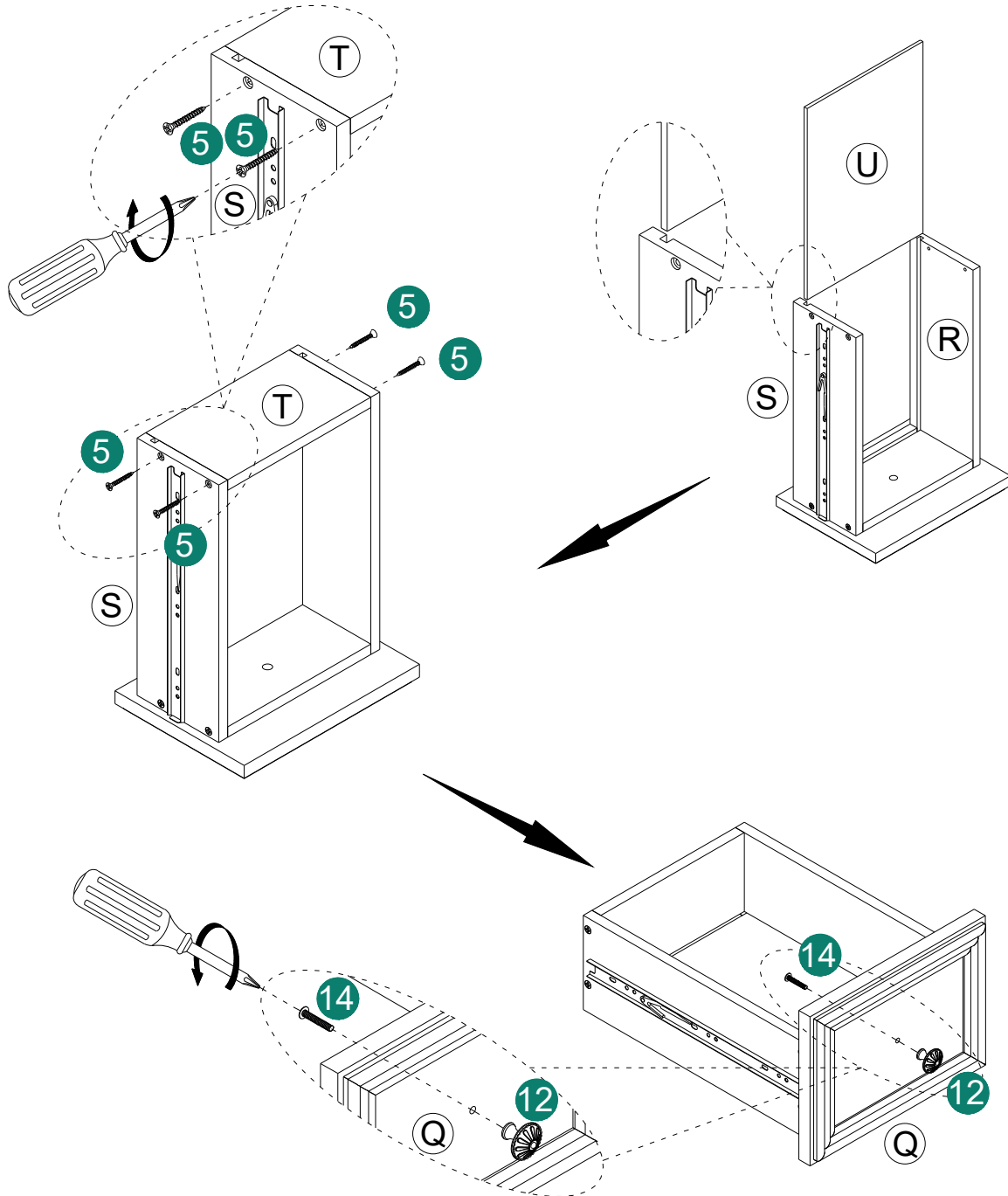

ASSEMBLY INSTRUCTIONS

14

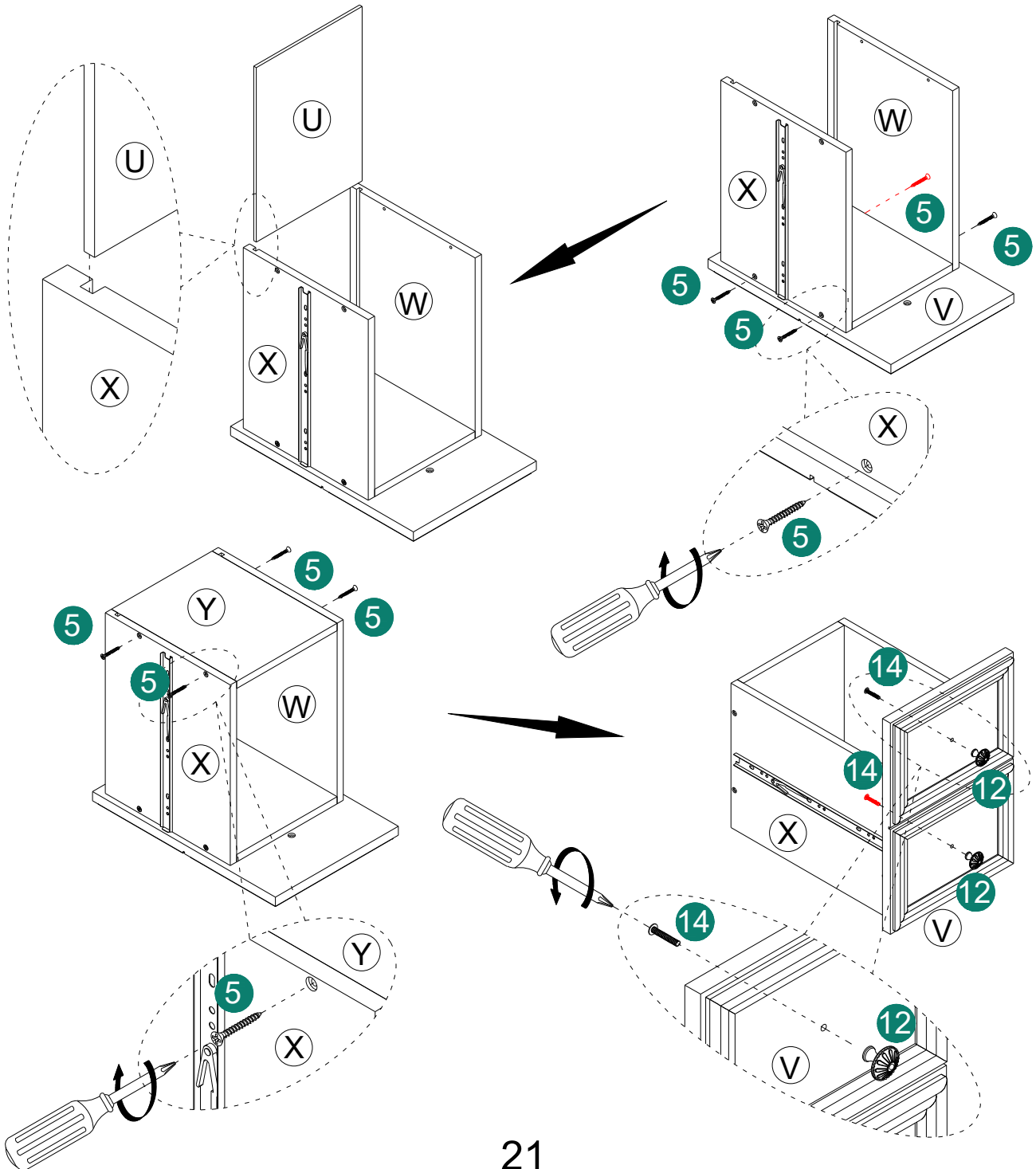
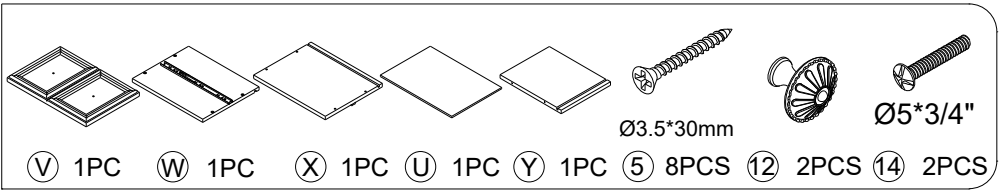

ASSEMBLY INSTRUCTIONS

15

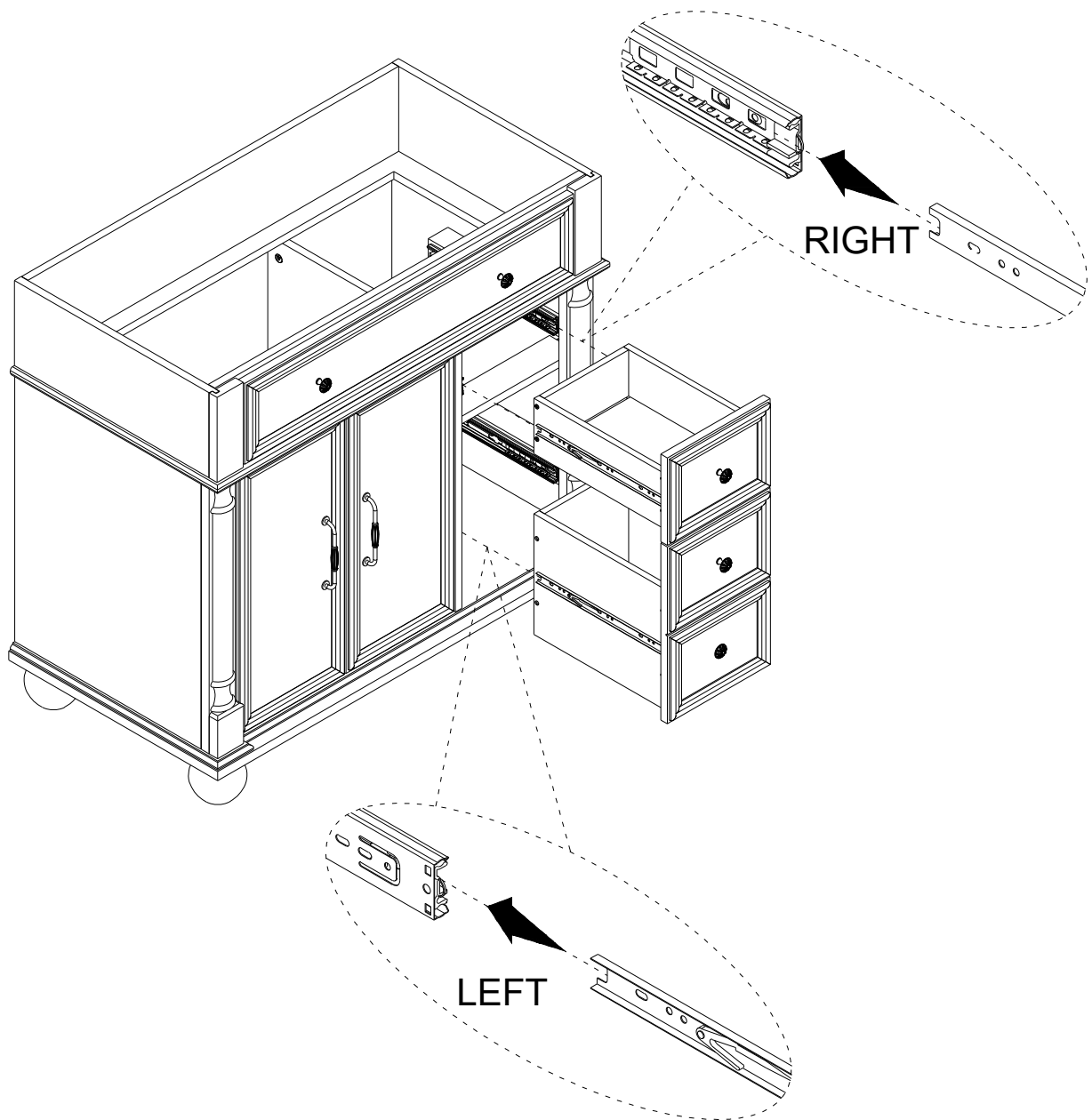

ASSEMBLY INSTRUCTIONS

16

