

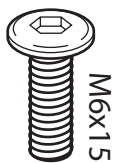

**Park Bench**

# PACKAGE CONTENT

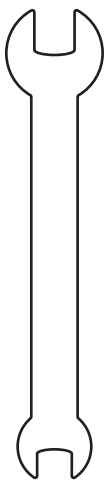
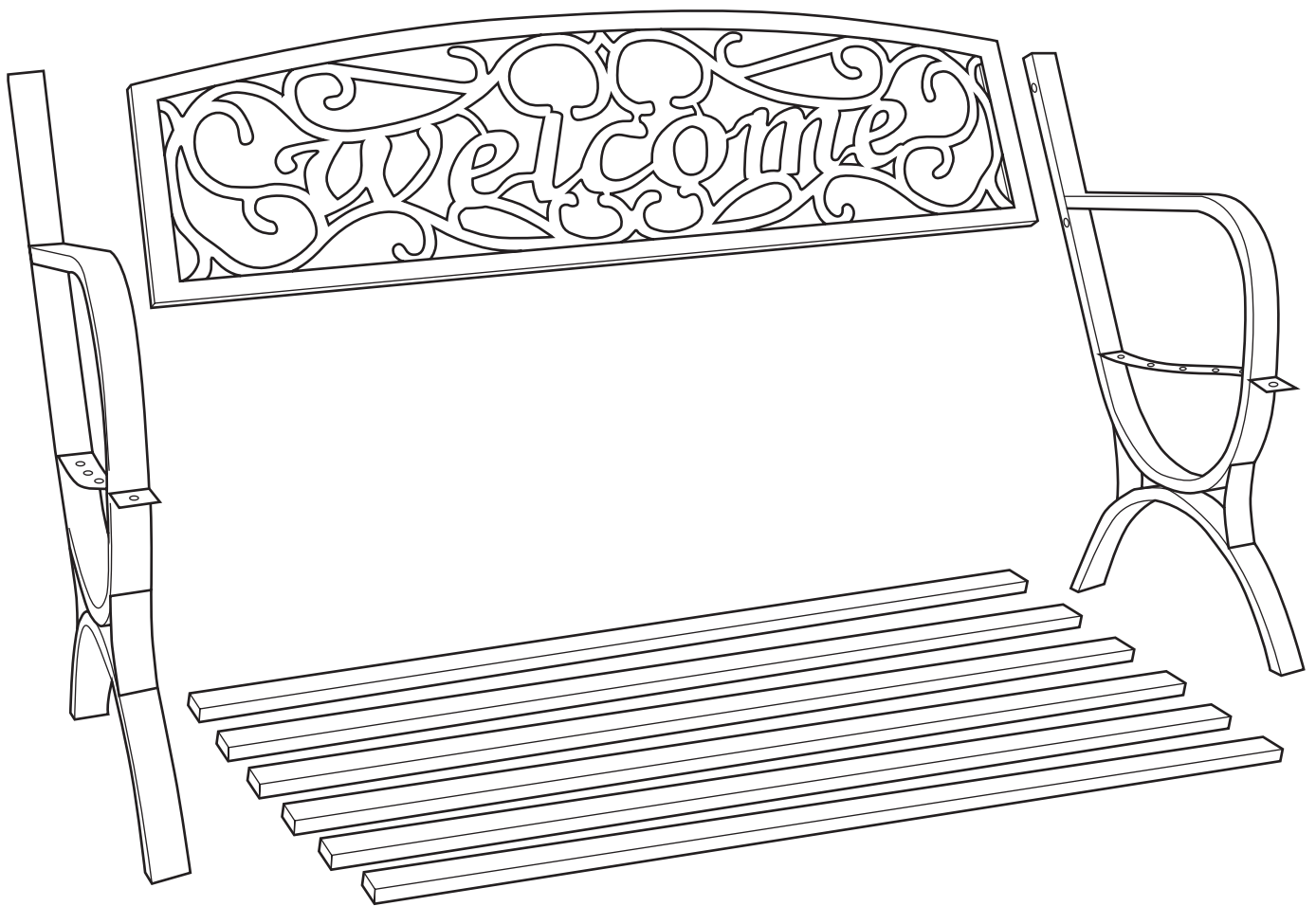

12x

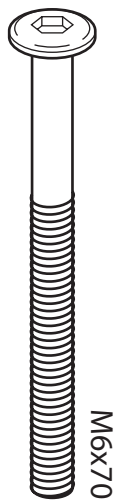

4x



4x



4x

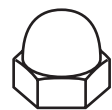

4x

# 1

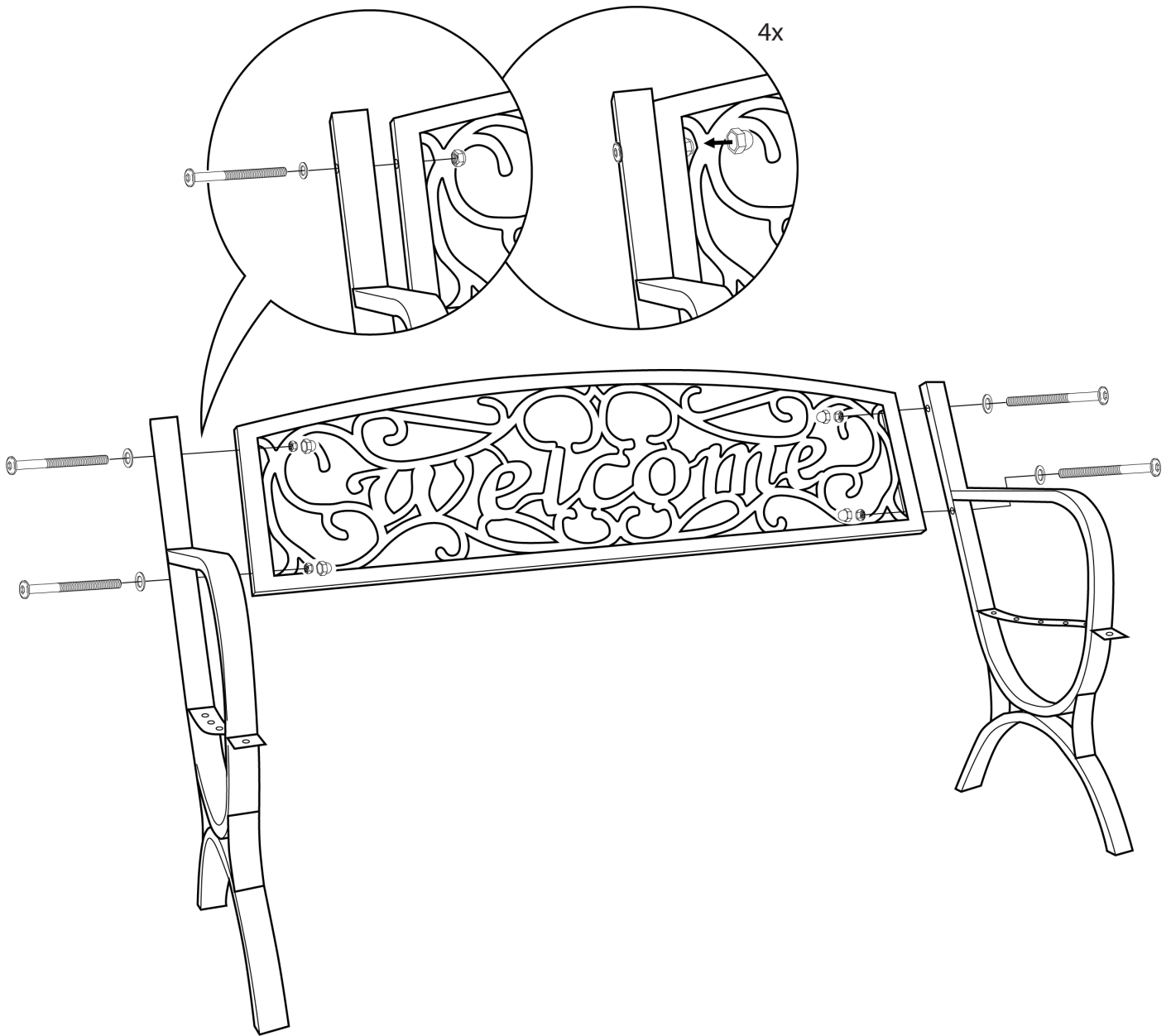

Hand tighten bolts to 60% to prevent holes from not aligning for the following steps.  
Failing to do so may result in disassembly to realign the holes.

# 2

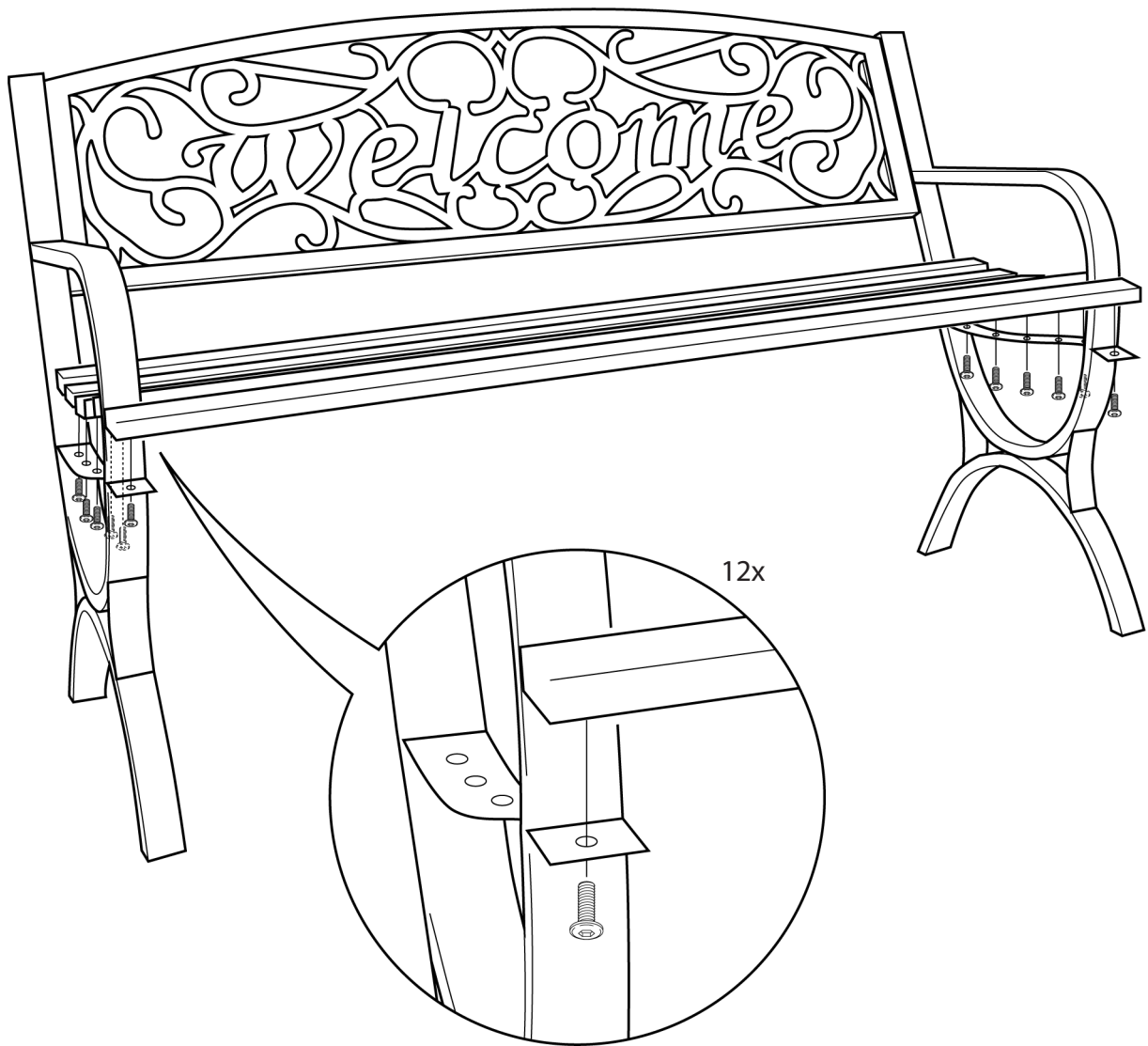

Make sure all bolts are tightly fastened before the unit is used.