

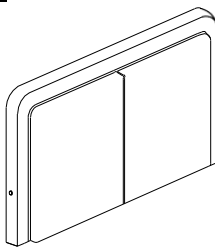

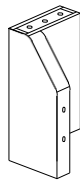
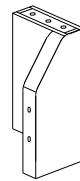
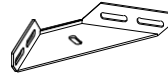
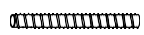

ASSEMBLY INSTRUCTIONS

LED QUEEN HEADBOARD

<p>A Headboard Panel 1PC</p> 	<p>B Headboard Leg LSF (In 462BQ-2) 1PC</p> 	<p>C Headboard Leg RSF (In 462BQ-2) 1PC</p> 	<p>D Metal Bracket (black) (In the Headboard Leg) 258 x 95 x 37 x 2mm 2PCS</p> 
<p>E Threaded Rod Ø5/16" x 3 1/4" 6PCS</p> 	<p>F Bolt Ø5/16" x 25mm 8PCS</p> 	<p>G Flat Washer Ø5/16" x 22mm 14PCS</p> 	<p>H Lock Washer Ø5/16" x 12mm 14PCS</p> 
<p>I Hex Nut Ø5/16" x 12 x 5mm 6PCS</p> 	<p>J Wrench M5 x 90mm 1PC</p> 	<p>K L-Allen Key 5mm 1PC</p> 	

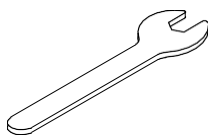
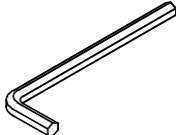
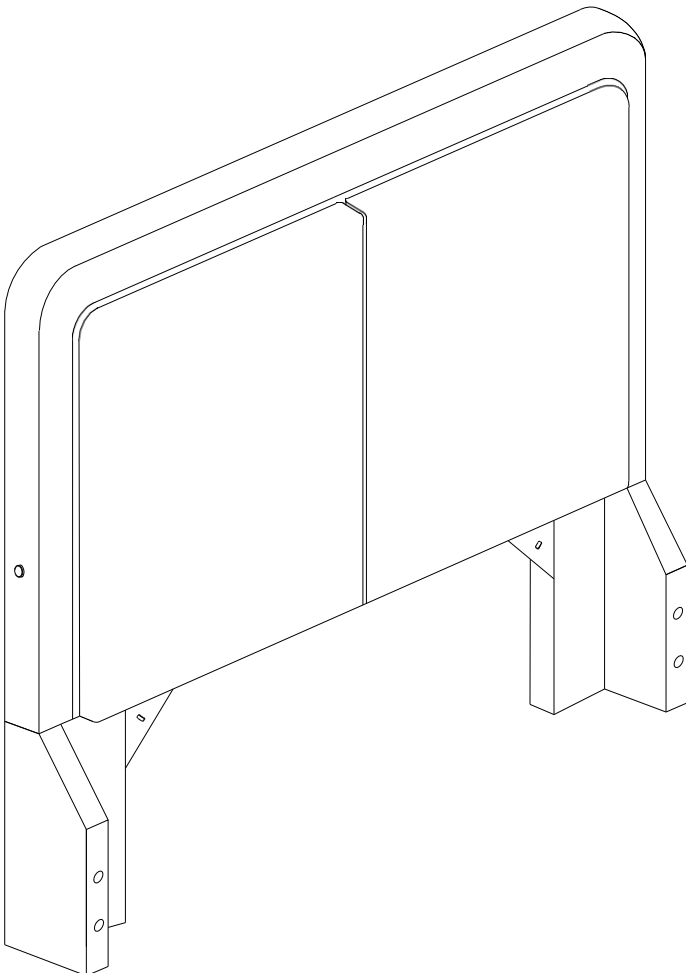

This page lists all the contents included in the box. Please take the time to identify the hardware as well as the individual components to this product. As you unpack and prepare for assembly, place the contents on a carpeted or padded area to protect them from damage.

- 1** Attach LSF & RSF Headboard Leg (B & C) to Headboard (A) using Threaded Rod (E), Flat Washer (G), Lock Washer (H) and Hex Nut (I) with Wrench (J).

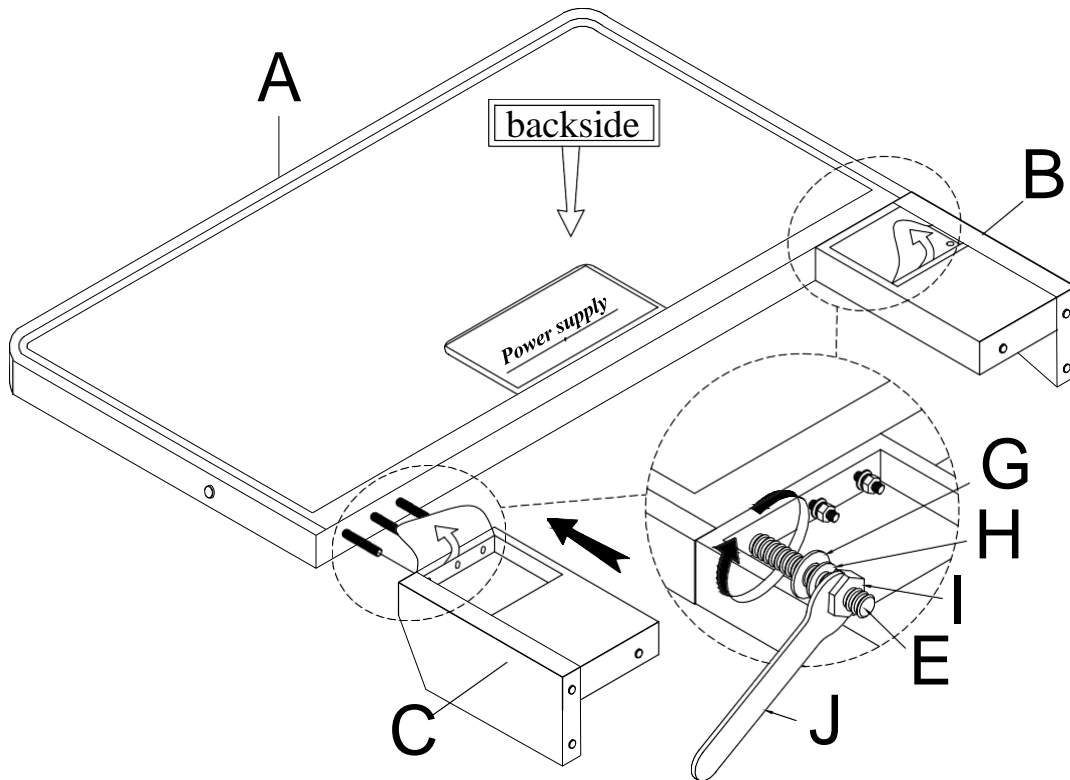

- 2** Attach Metal Bracket (D) to Headboard (A) and LSF & RSF Headboard Leg (B & C) using Bolt (F), Lock Washer (H) and Flat Washer (G) with L-Allen Key (K).

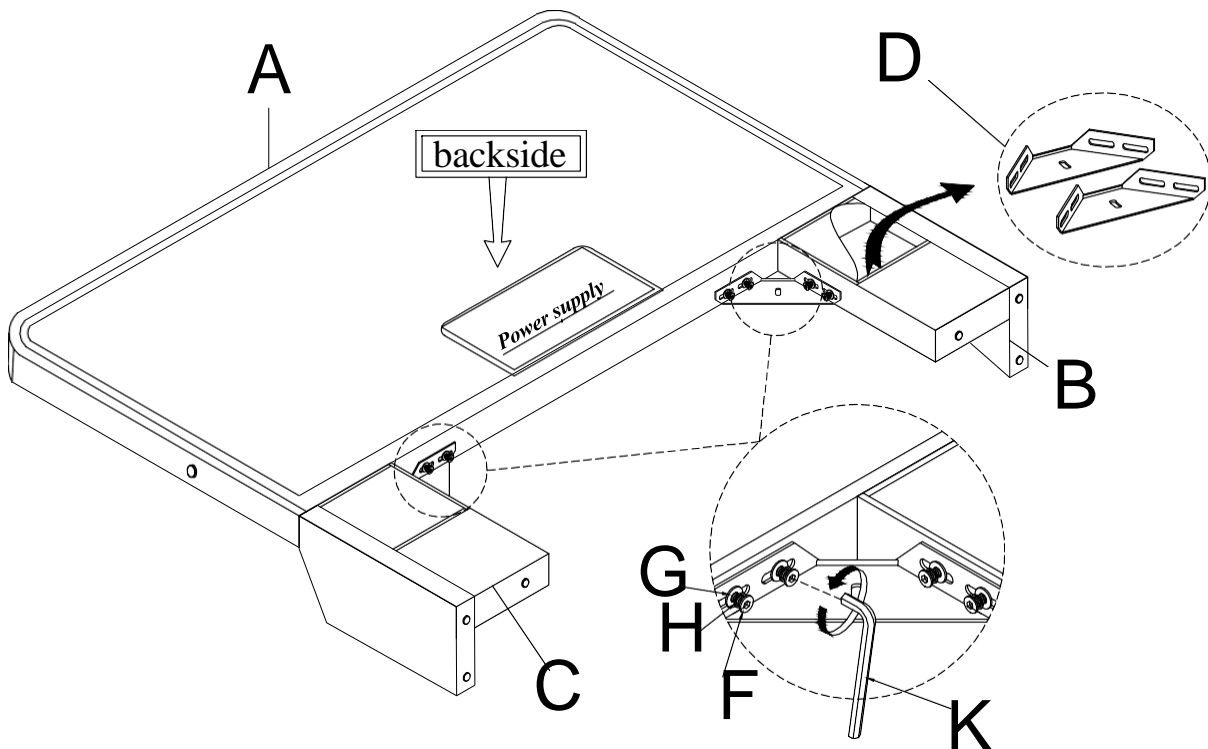







Cleaning & Care

Treat surfaces with care. Surfaces are resistant to scratches but are not scratch resistant. Clean surfaces with a dry or damp soft cloth. Do not use abrasive cleaners. Hardware may loosen over time. Periodically check that all connections are tight.

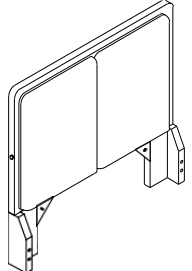
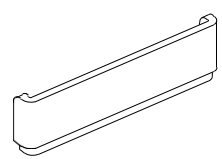
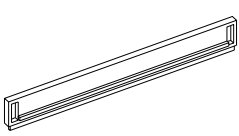
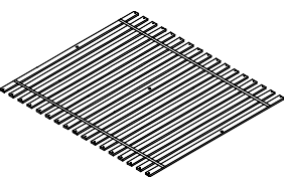
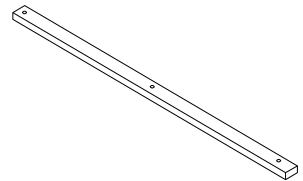
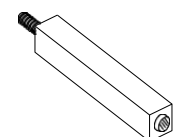
ASSEMBLY INSTRUCTIONS

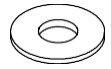
462BQ-2 LED QUEEN FOOTBOARD & HEADBOARD LEGS & SLATS

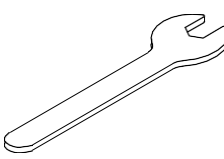
462BQ-3 LED QUEEN RAILS & SUPPORT LEGS & CENTER BAR

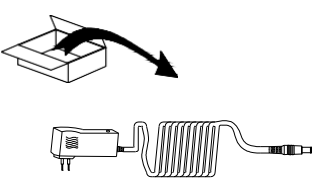
<p>A Headboard (In 462BQ-1)</p>  <p>1PC</p>	<p>B Footboard</p>  <p>1PC</p>	<p>C Side Rail (In 462BQ-3)</p>  <p>2PCS</p>	<p>D Slat</p>  <p>1SET (17PCS)</p>	<p>E Center Bar (In 462BQ-3)</p>  <p>1PC</p>
<p>F Center Support Leg (In 462BQ-3)</p>  <p>3PCS</p>	<p>G Threaded Rod Ø5/16" x 80mm</p>  <p>8PCS</p>	<p>H Flat Washer 5/16" x 22mm</p>  <p>8PCS</p>	<p>I Lock Washer Ø5/16" x 12mm</p>  <p>8PCS</p>	<p>J Hex Nut Ø5/16" x 12 x 5mm</p>  <p>8PCS</p>
<p>K Wrench M5 x 90mm</p>  <p>1PC</p>	<p>L Screw Ø8 x 38mm</p>  <p>34PCS</p>	<p>M Electricity Plug</p>  <p>1PC</p>		

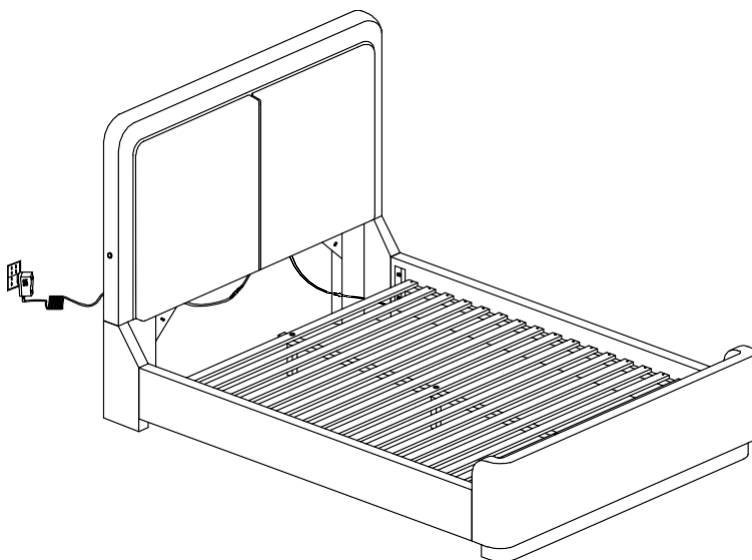

This page lists all the contents included in the box. Please take the time to identify the hardware as well as the individual components to this product. As you unpack and prepare for assembly, place the contents on a carpeted or padded area to protect them from damage.

- 1** Attach Side Rail (C) to Headboard (A) and Footboard (B) using Threaded Rod (G), Flat Washer (H), Lock Washer (I) and Hex Nut (J) with Wrench (K).

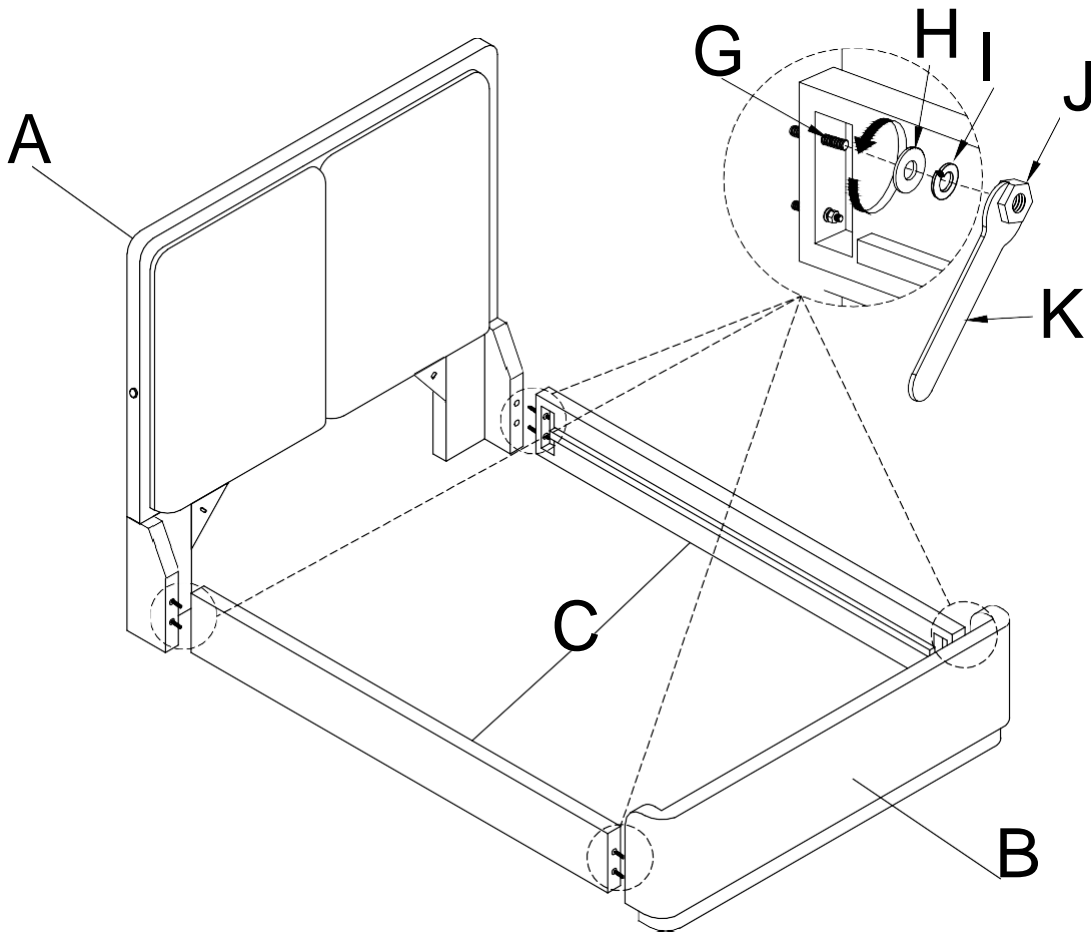

- 2** Rotate and attach Center Bar (E) and Center Support Leg (F) to Slat (D).

