

Tools Recommended

EN_IMPORTANT, RETAIN FOR FUTURE REFERENCE: READ CAREFULLY.

FR_IMPORTANT: A LIRE ATTENTIVEMENT ET À CONSERVER POUR CONSULTATION ULTÉRIEURE.

ES_IMPORTANTE, LEA Y GUARDE PARA FUTURAS REFERENCIAS.

PT_IMPORTANTE, RETER PARA REFERÊNCIA FUTURA: LEIA ATENTAMENTE.

DE_WICHTIG! SORGFÄLTIG LESEN UND FÜR SPÄTER NACHSCHLAGEN AUFBEWAHREN.

IT_IMPORTANTE! CONSERVARE IL PRESENTE MANUALE PER FUTURO RIFERIMENTO E LEGGERLO ATTENTAMENTE.

BOX 1-3 **A1** x 1

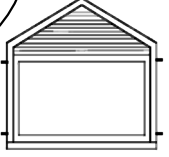

A2 x 1

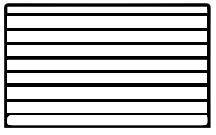

C1 x 1



I x 2

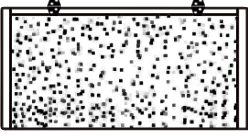

L x 1

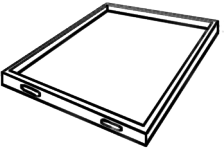

M x 4

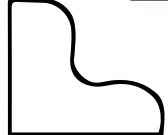

X x 1

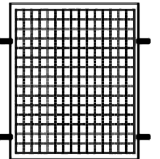

Y x 3

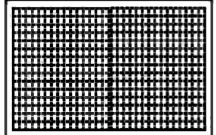

Hardware Kit



BOX 2-3 **B1** x 1

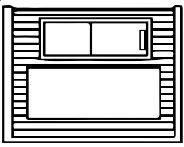

B2 x 1

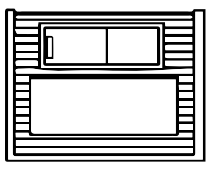

C2 x 1

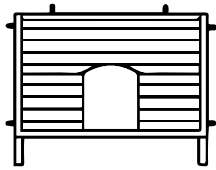

D x 1

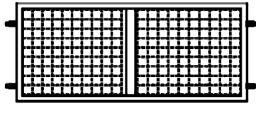

G x 2

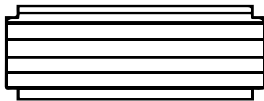

H x 2

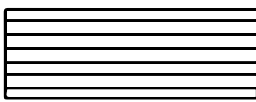

J x 2

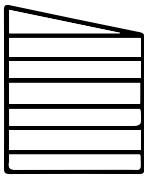

K x 2

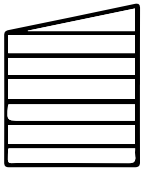

BOX 2-3 **P** x 1

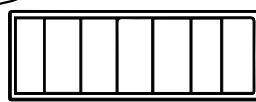

R x 1

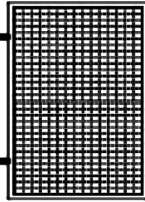

S x 1

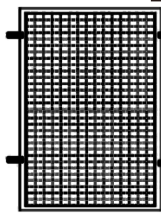

T x 1

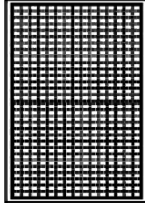

U x 1

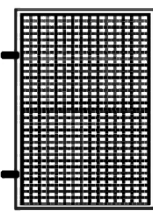

V x 1

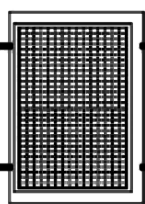

W x 1

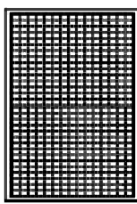

BOX 3-3 **E** x 1

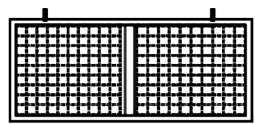

F x 1

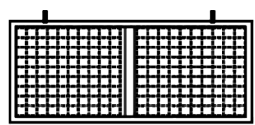

N x 2



O1 x 2



O2 x 2

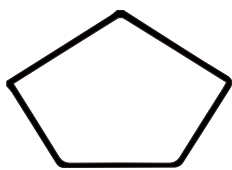

Q x 2

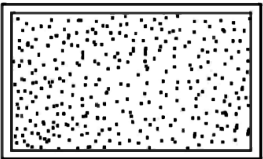

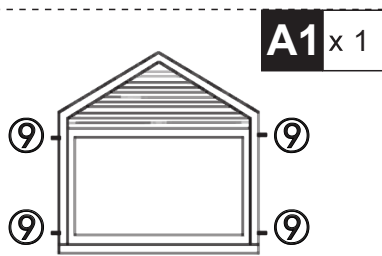

A1 x 1

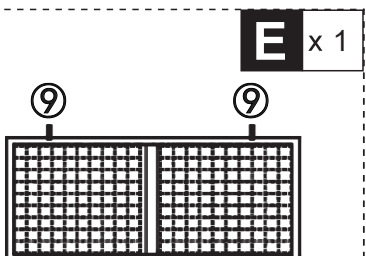

E x 1

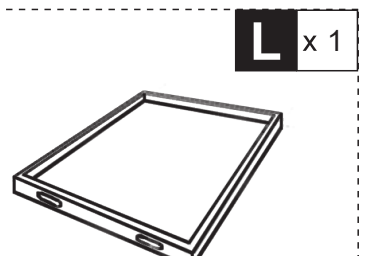

L x 1

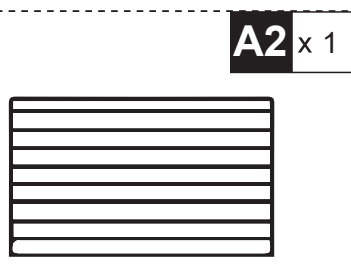

A2 x 1

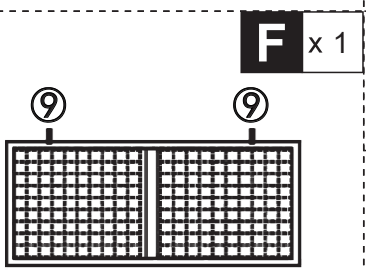

F x 1



M x 4

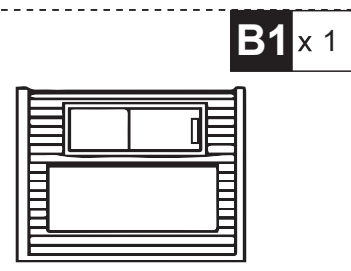

B1 x 1

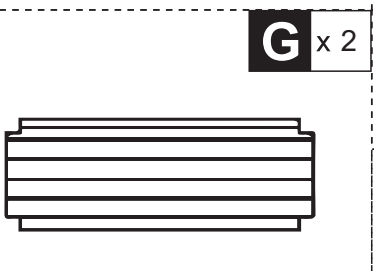

G x 2

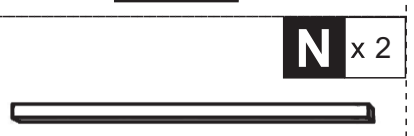

N x 2

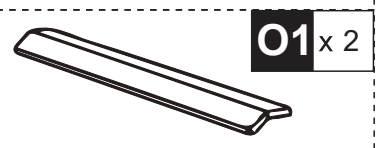

O1 x 2

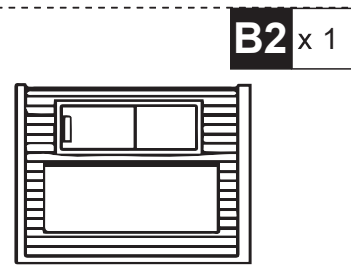

B2 x 1

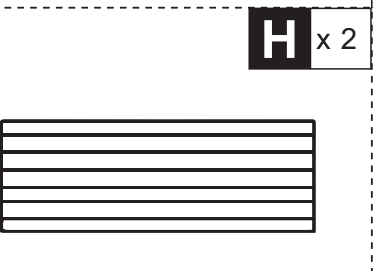

H x 2

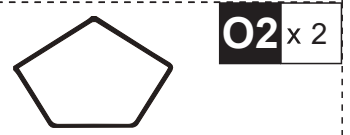

O2 x 2

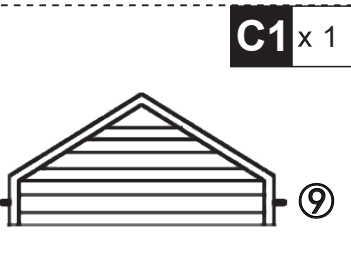

C1 x 1

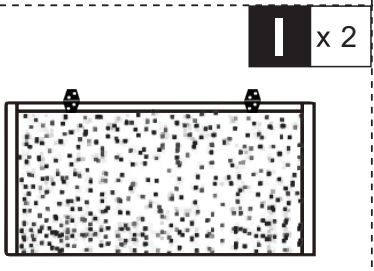

I x 2

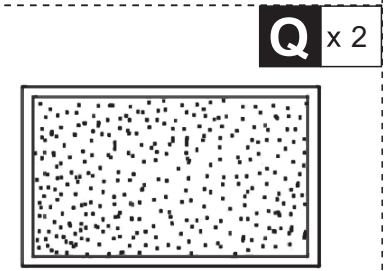

Q x 2

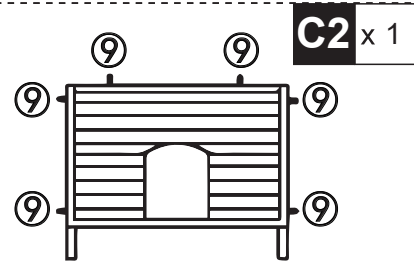

C2 x 1

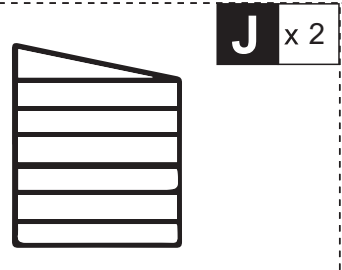

J x 2

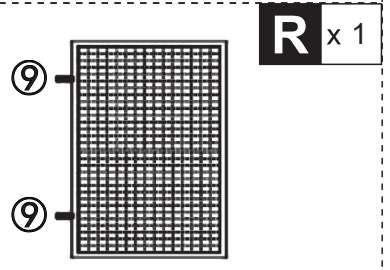

R x 1

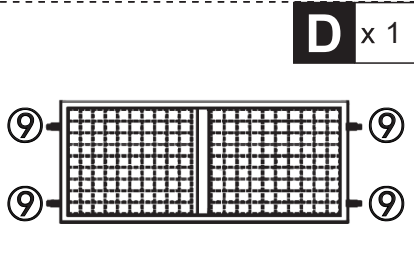

D x 1

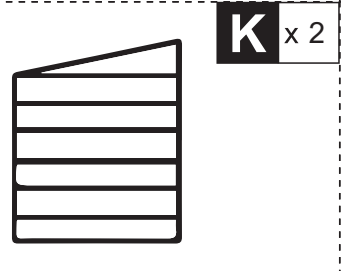

K x 2

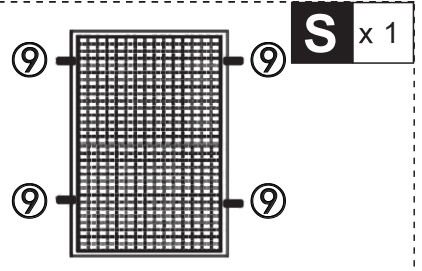

S x 1

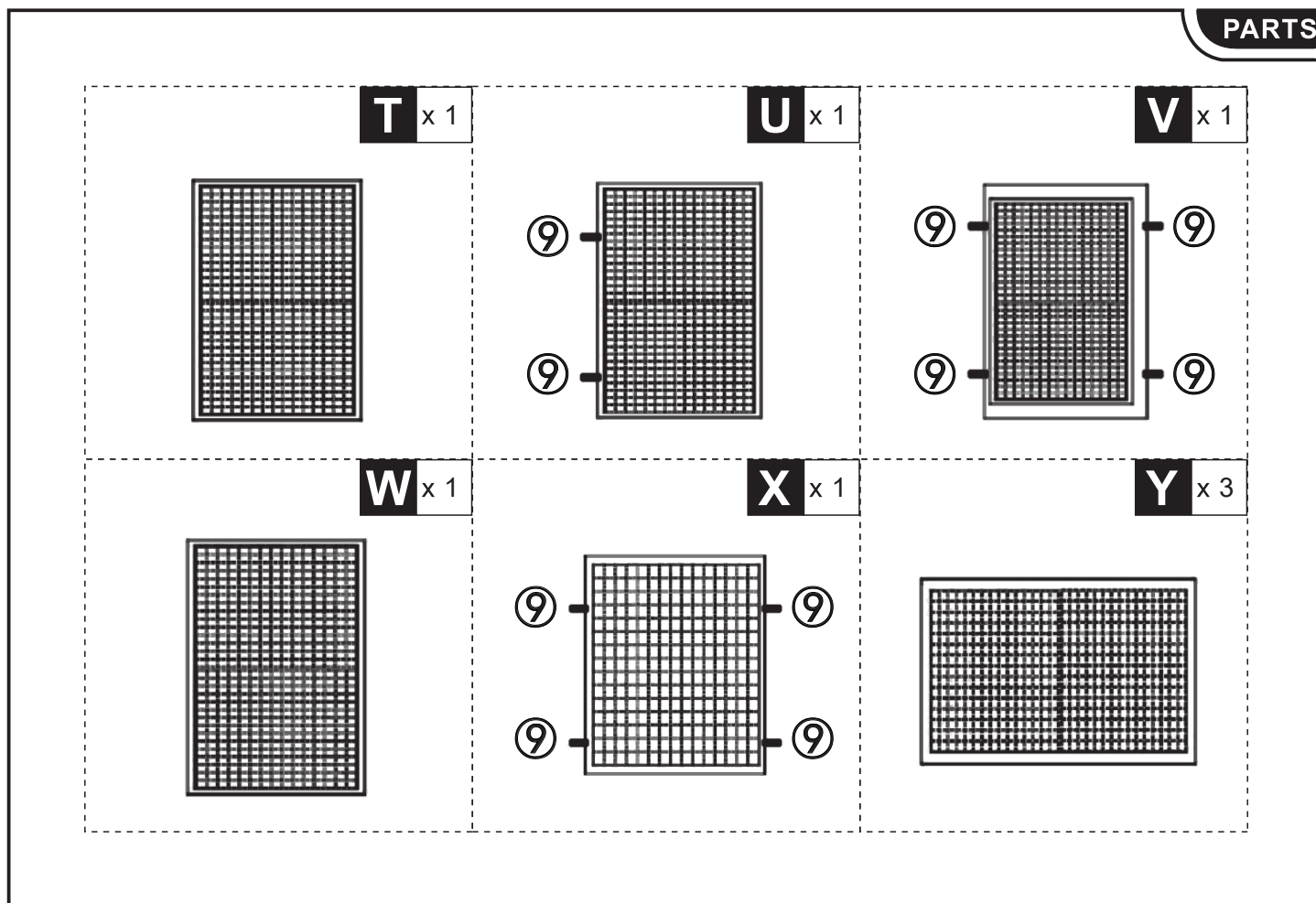

HARDWARE

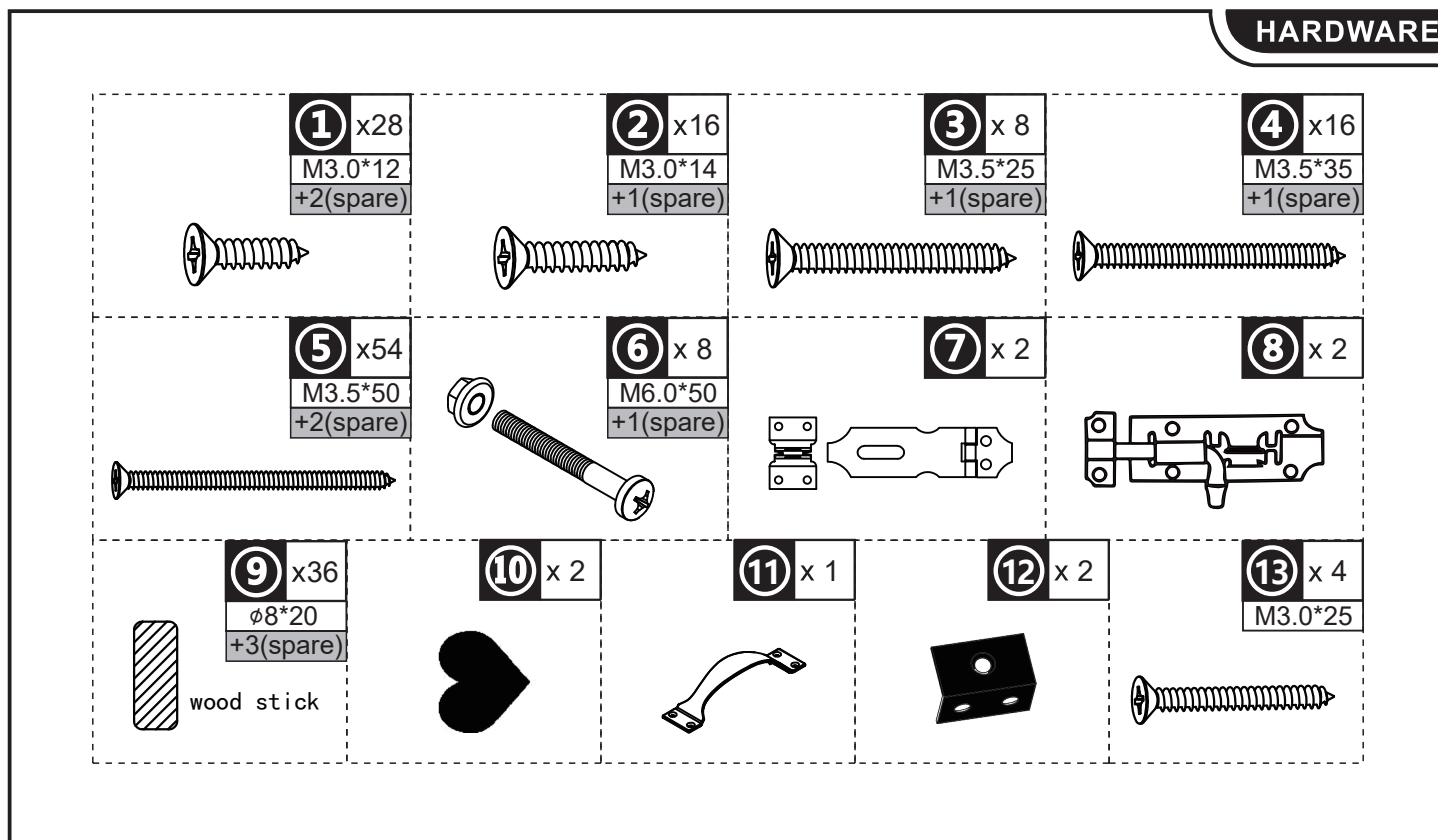

EN Do not confuse similar screws.
FR Ne pas confondre des vis similaires.
ES No confunda tornillos similares.
PT Não confundir parafusos semelhantes.
DE Verwechseln Sie ähnliche Schrauben nicht.
IT Non confondere le viti simili.

NOTE

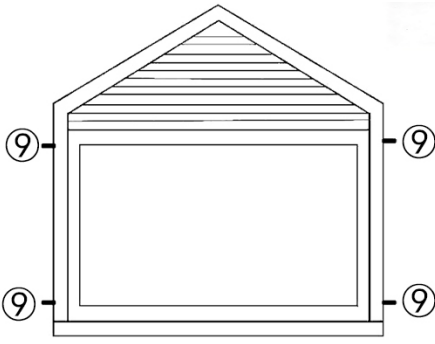

A1

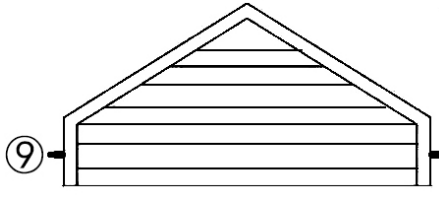

C1

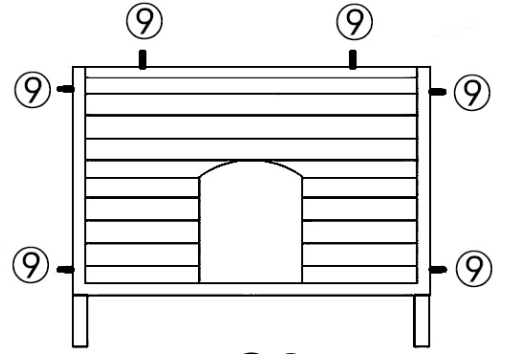

C2

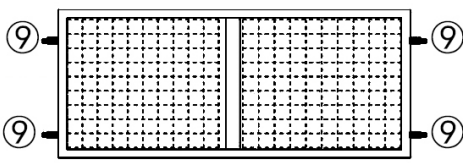

D

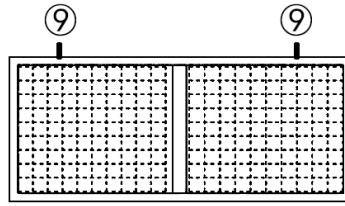

E

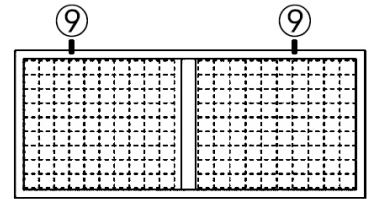

F

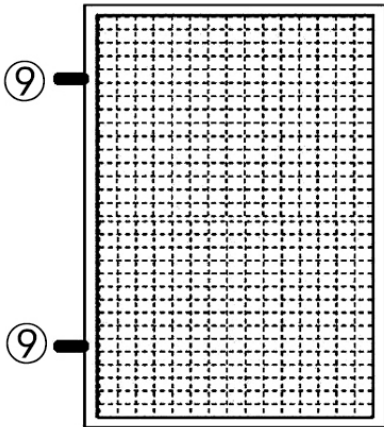

R

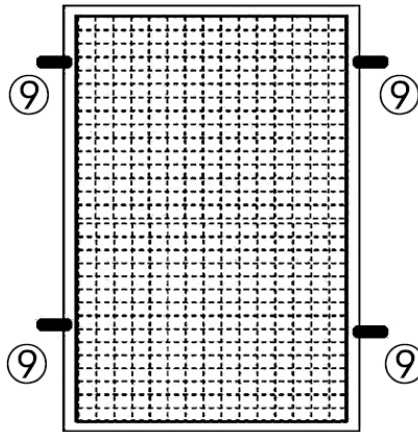

S

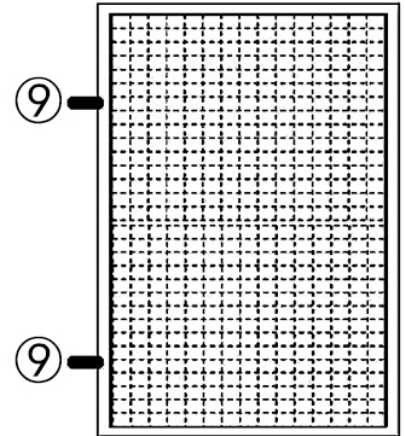

U

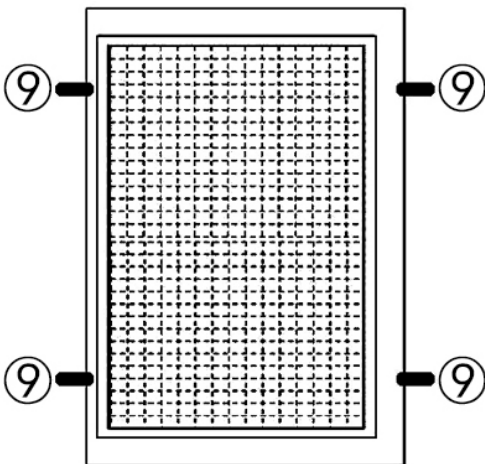

V

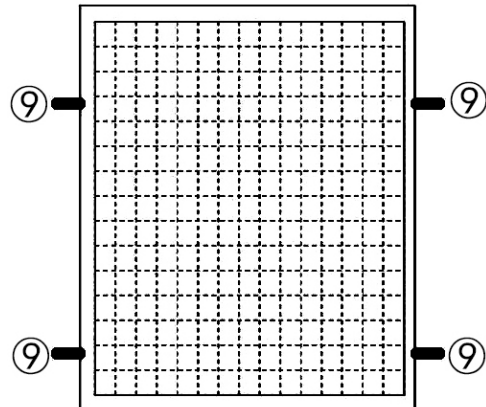

X

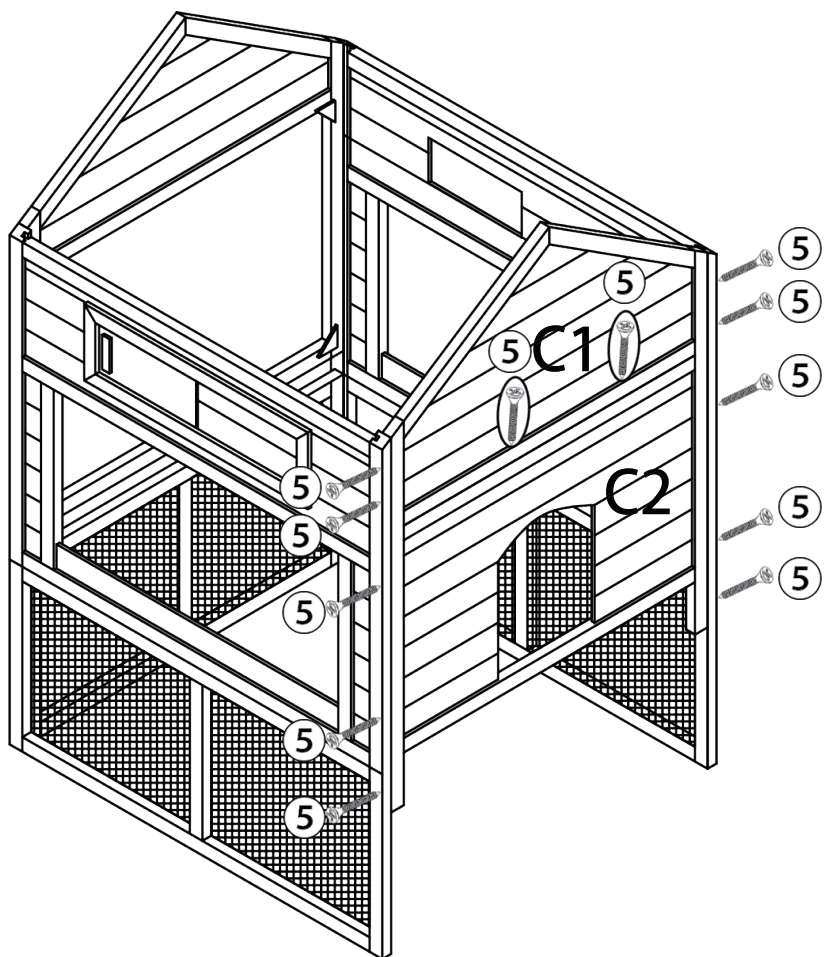
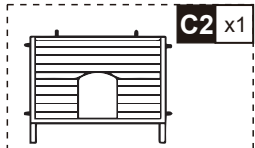
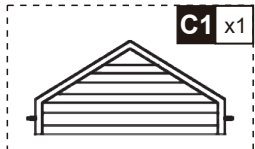
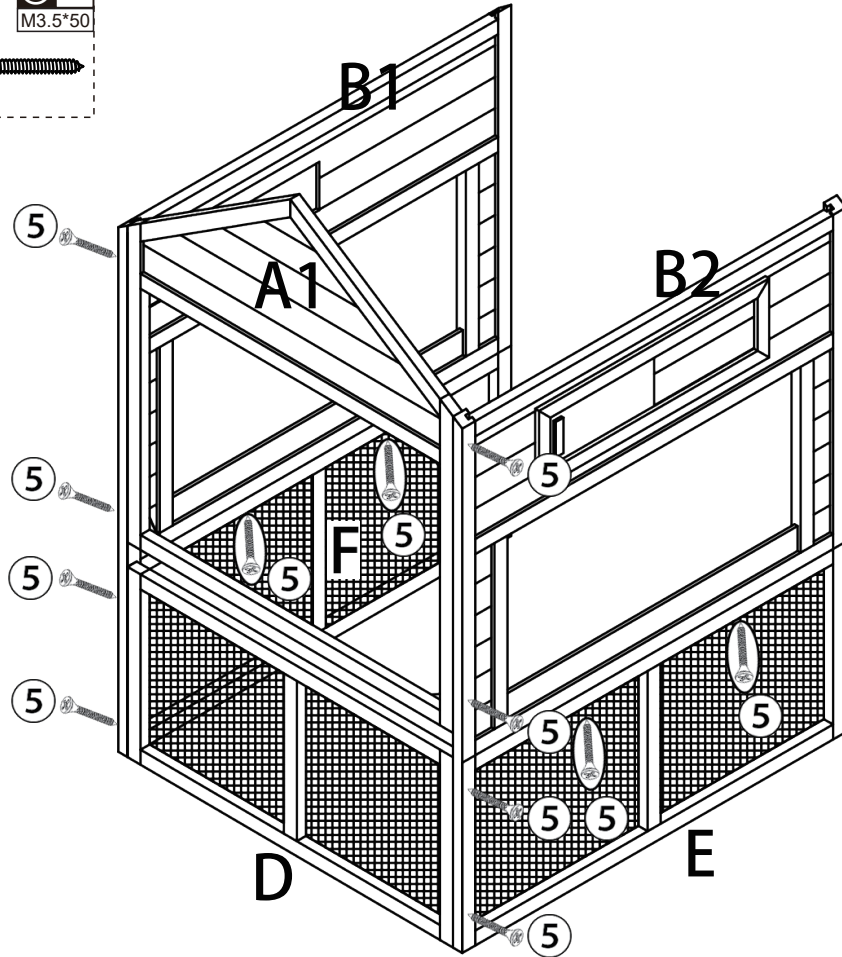
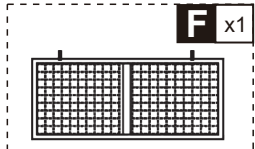
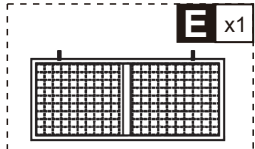
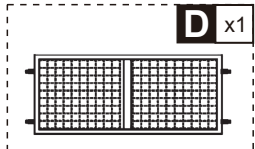
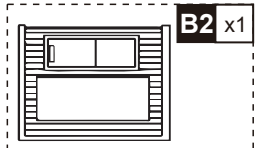
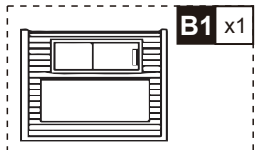
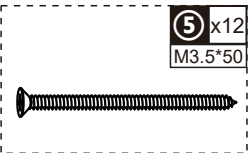
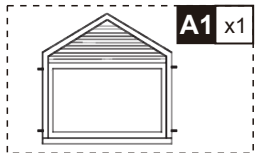

A2 x1

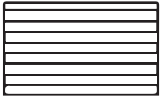

11 x1



L x1

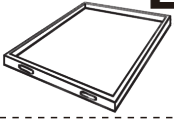

N x2



1 x4
M3.0*12

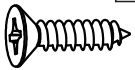

2 x2
M3.0*14



10 x2

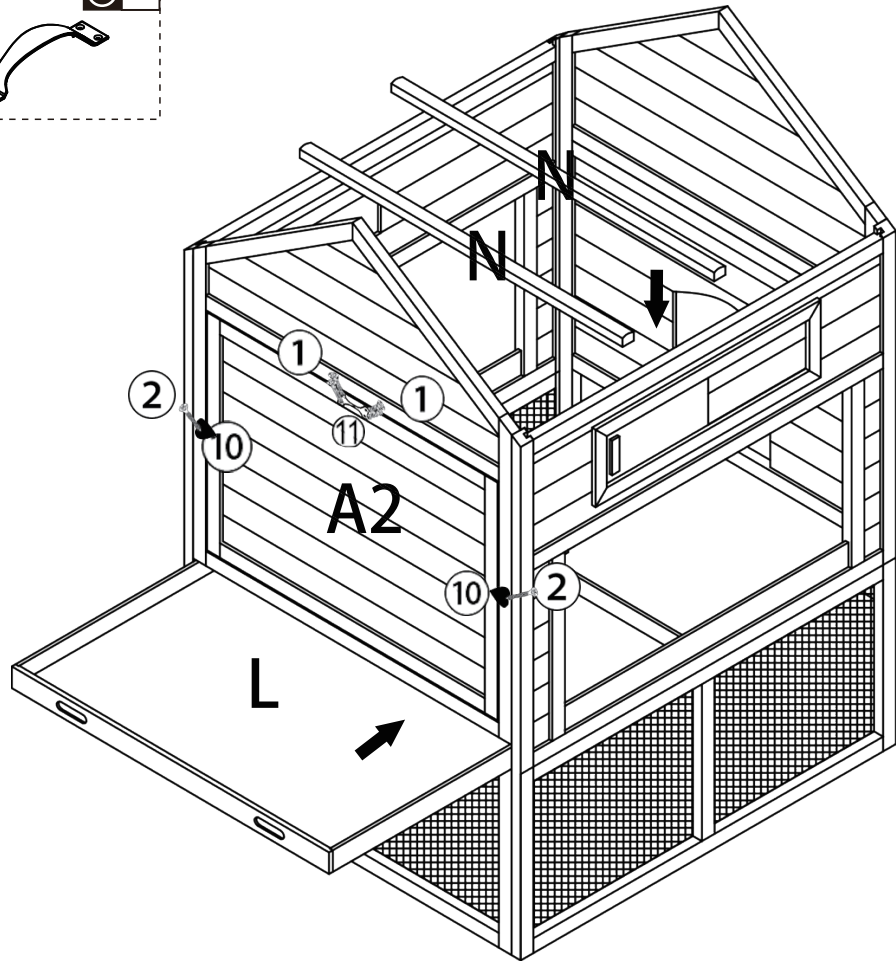

G x2

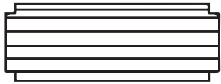

J x2

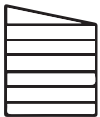

K x2

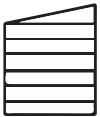

6 x8
M6.0*50

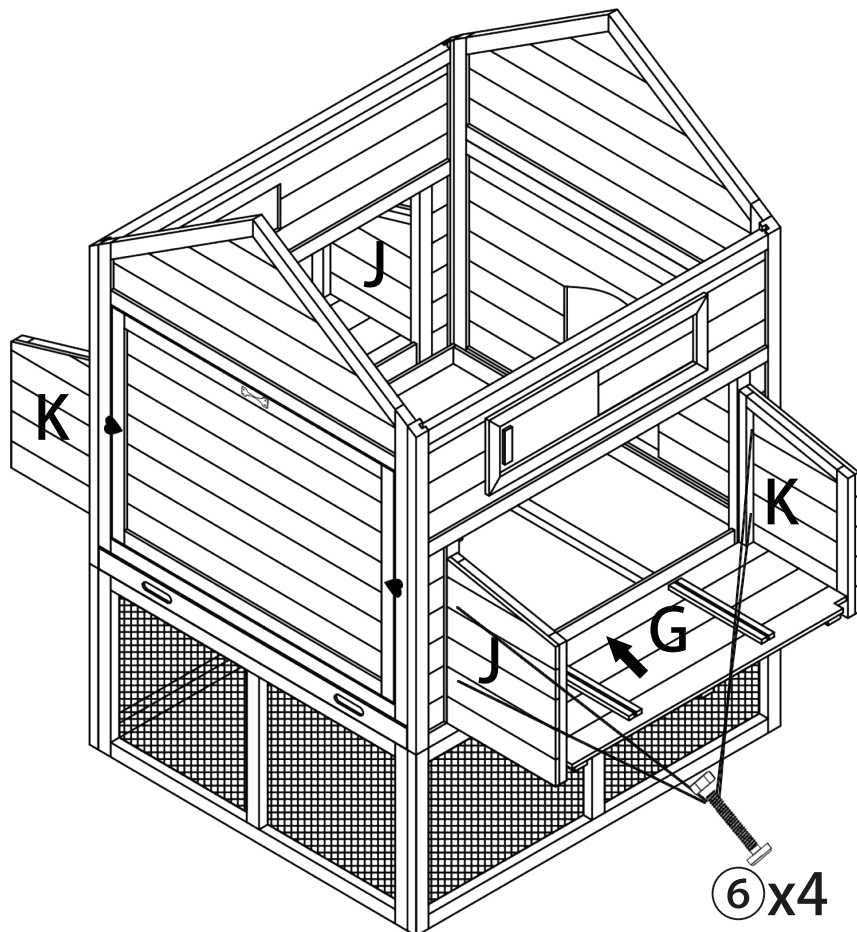
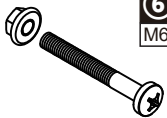

H x2

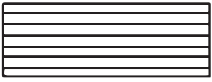

M x4



4 x8
M3.5*35

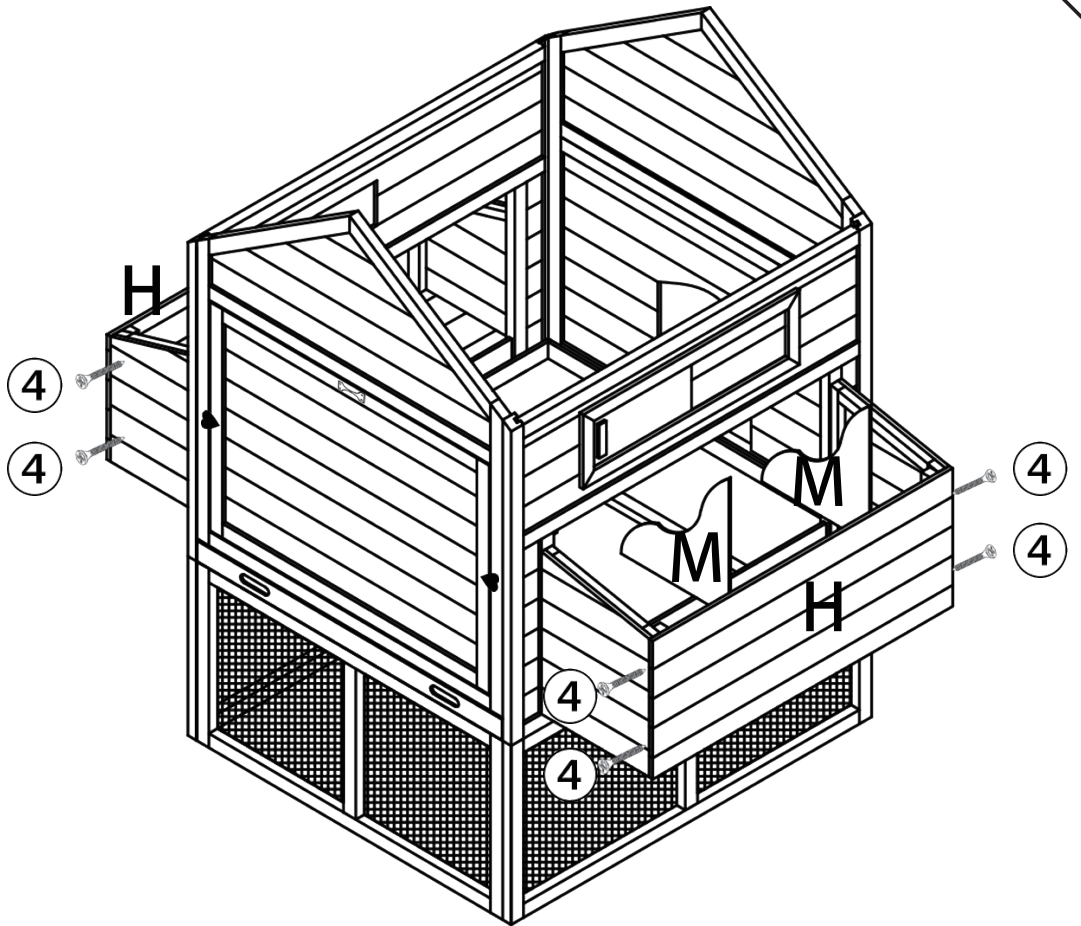

I x2

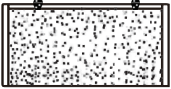

1 x12
M3.0*12

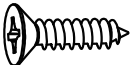

2 x8
M3.0*14

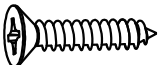

7 x2

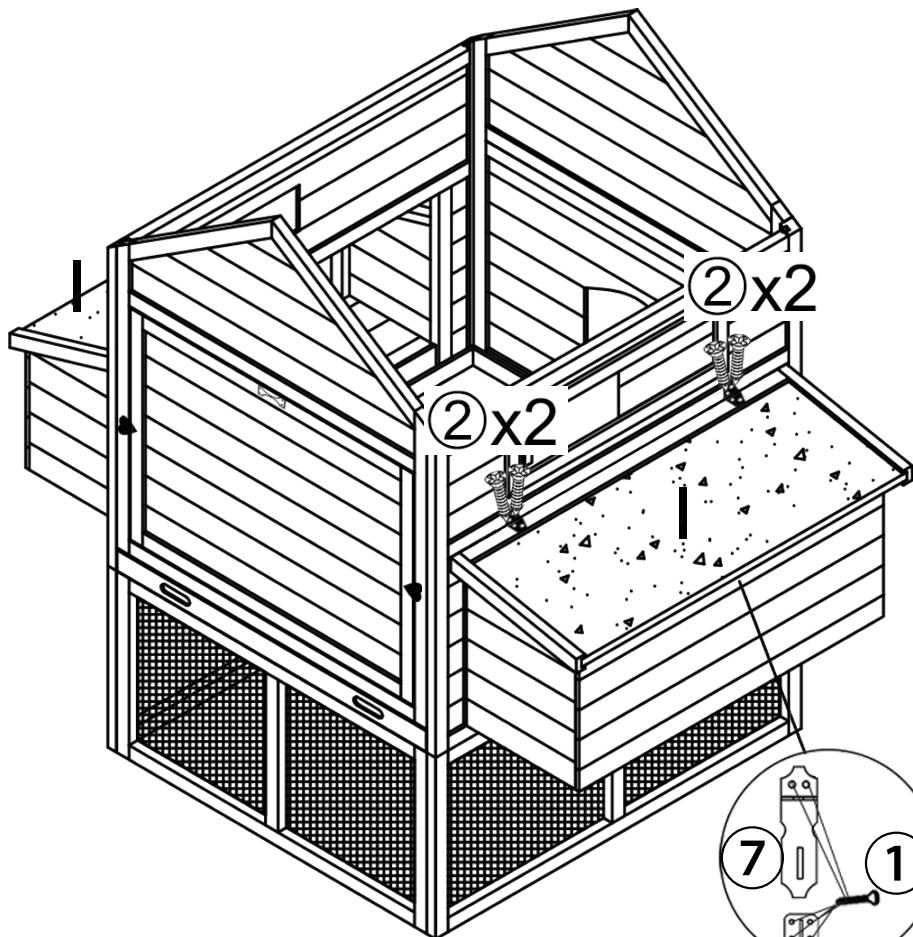

P x1

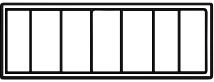

Q x2

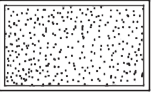

2 x6
M3.0*14



4 x8
M3.5*35



12 x2

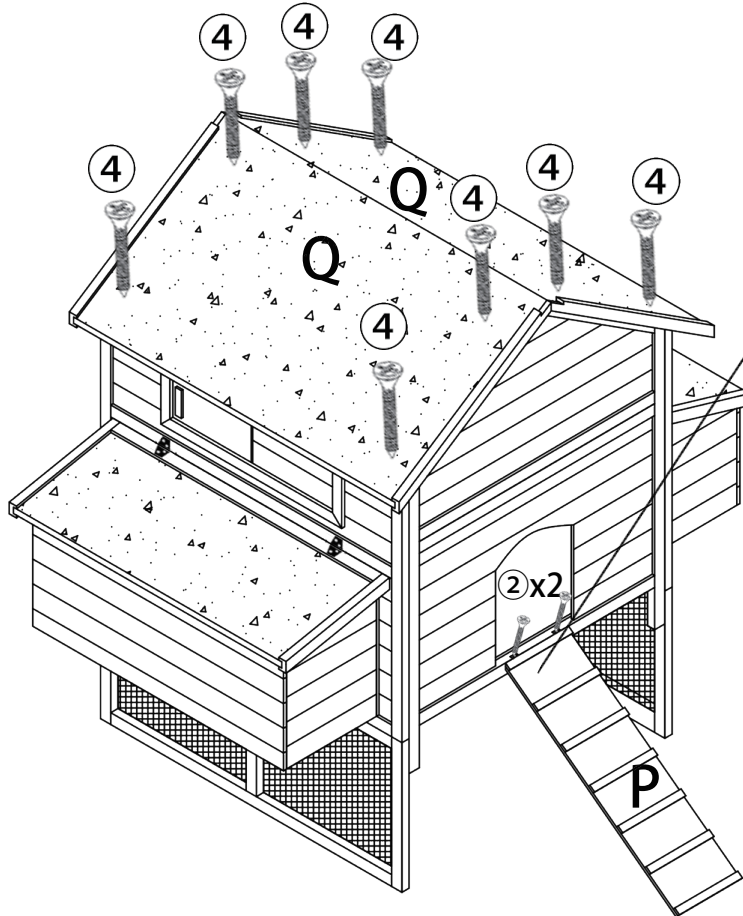

01 x2



02 x2



R x1

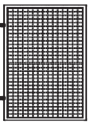

S x1

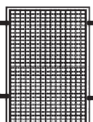

T x1

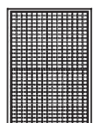

3 x8
M3.5*25



5 x6
M3.5*50



13 x4
M3.0*25

