

USER MANUAL BID 01

WOODBIDGE®

Remote Control Illustration

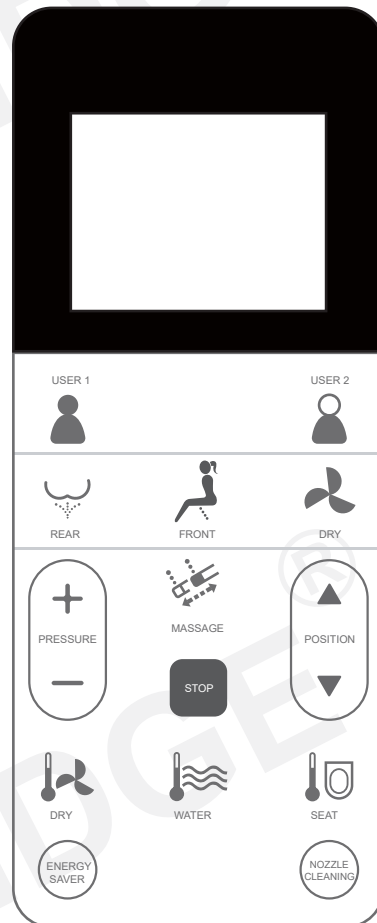

Thank you for choosing our product. Please read the instructions carefully before installation and keep it available for future maintenance or reference.



SCAN ME

Customer Service Phone: 562-229-0088. (Monday - Friday 9 AM - 5 PM Pacific Time)

Or Email: help@woodbridgebath.com

Installation Preparation

Remote control installation

Remote control hanger installation

- (1) Drill a hole of $\phi 6\text{mm}$ on the wall with depth of 35mm.

Make sure end-user be able to reach the remote control when sitting on the seat.

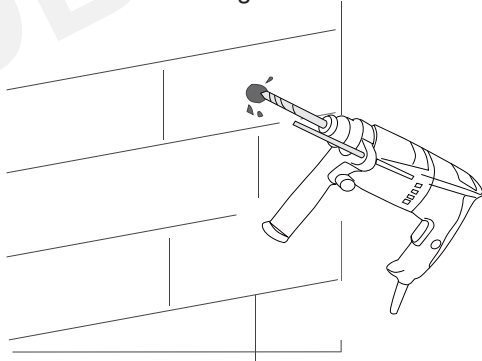

- (2) Tear the paster on back of hanger.

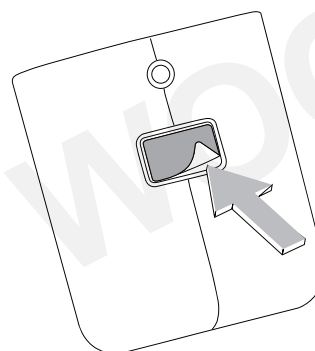

- (3) Insert expansion tube into the hole on the wall, install the hanger to the wall with a screw, and paste the double faced adhesive tape on hanger to the wall, tighten the screw.

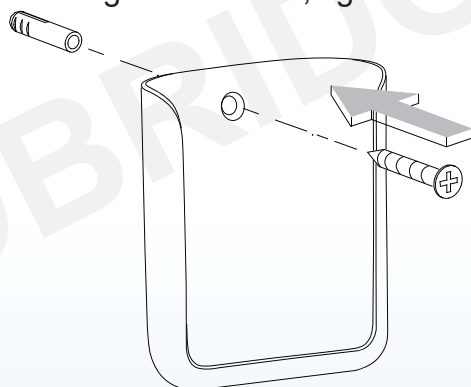

- (4) Install battery and place remote control to the hanger.



Notice: Please do not install and use the product in moist place, such as steam room, and prohibit to place in the space where is easily got wet.

Usage Instruction

Remote control illustration

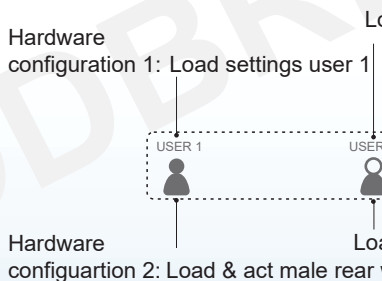
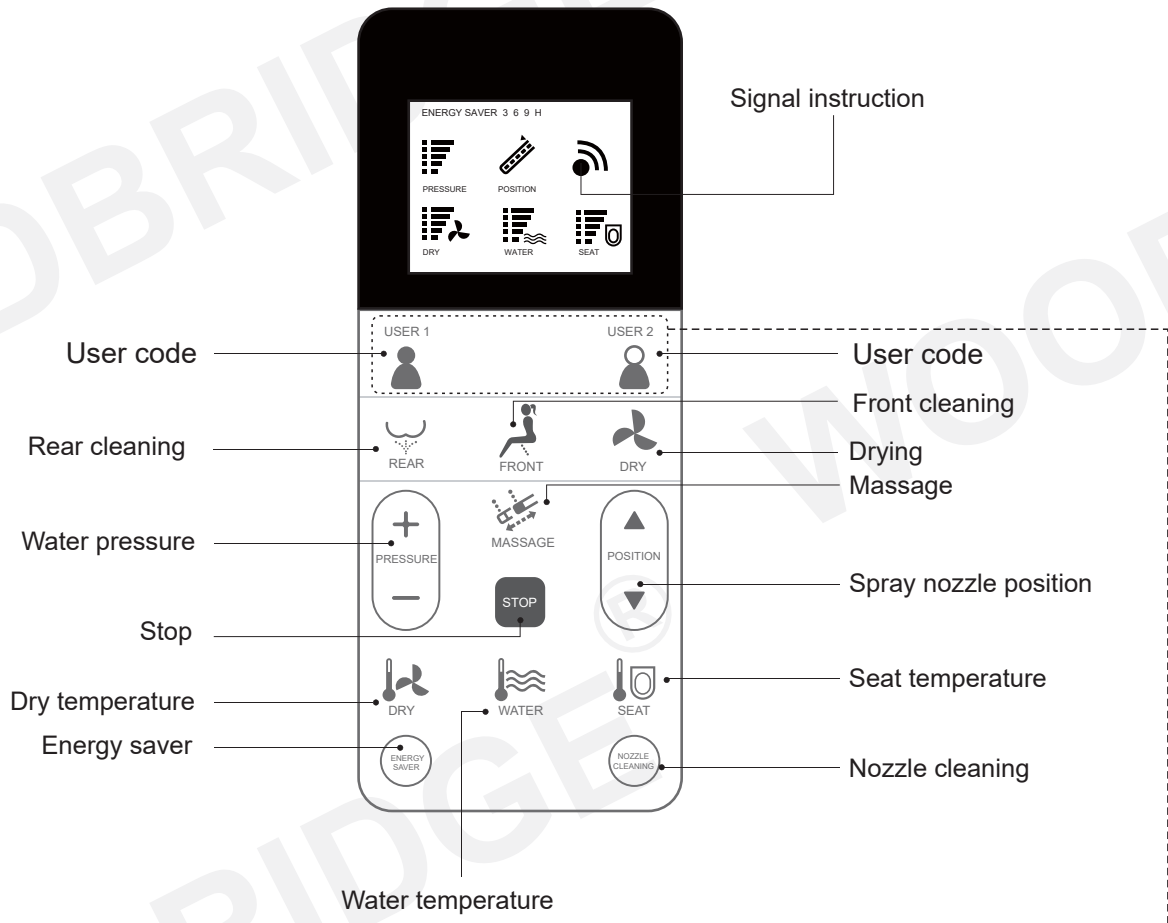

Picture 1
Please refer to page 8 for operation method

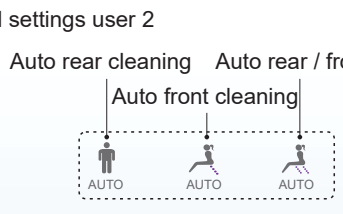

Picture 2
Please refer to page 9 and 11 for operation method

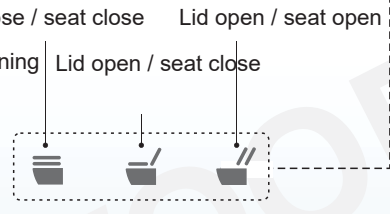

Picture 3
Please refer to page 8 for operation method

Usage Instruction

Rear/Front cleaning

Press “REAR”/“FRONT” button, the water comes out of wand to clean the rear/front portion of body. It automatically stops after a cycle of cleaning. If press “STOP” button when using, the function will stop immediately.

Drying Operation

Press “DRY” button, warm wind comes out of wand to dry. After a cycle or user leaves the seat, it automatically stops.

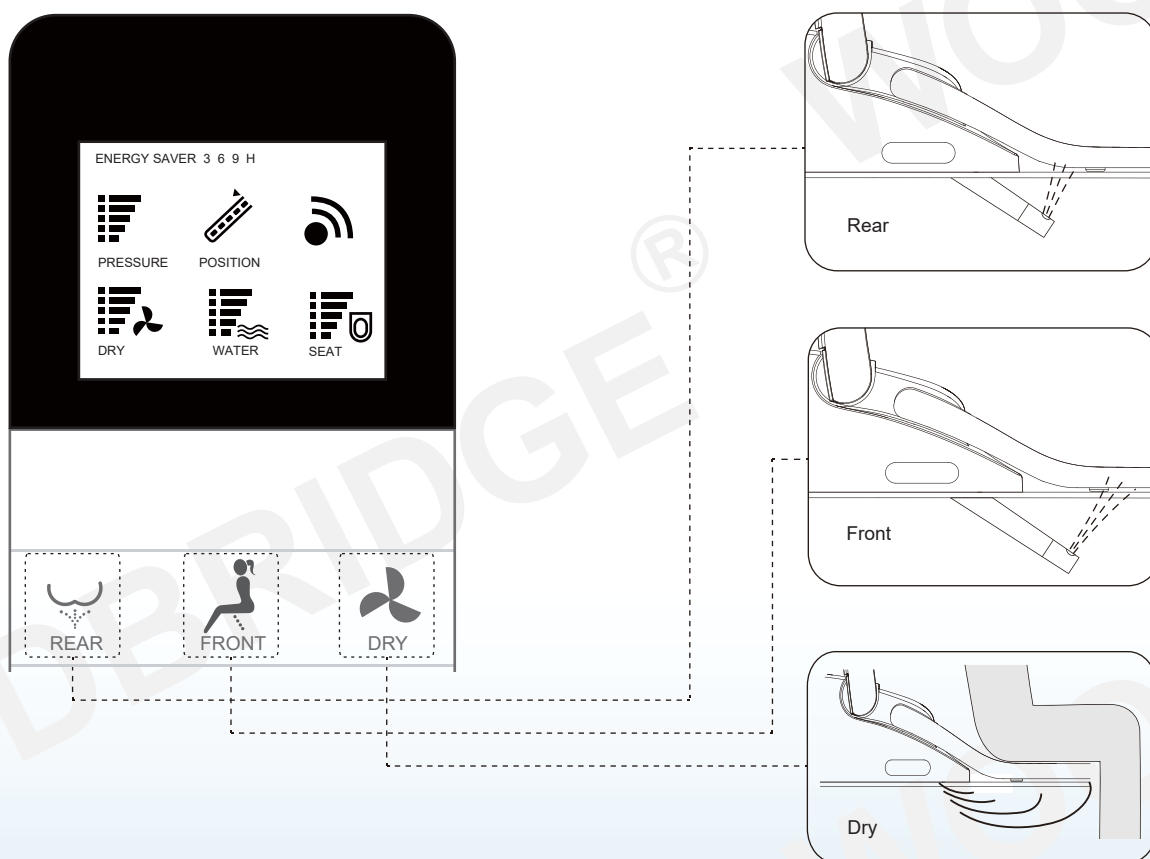

Usage Instruction

Massage

Press “MASSAGE” button to activate massage function, the nozzle moves forward and back to extend the cleaning scope; Press “MASSAGE” button again to stop the function.

Spray nozzle position adjustment

During “REAR” or “FRONT”, press spray nozzle button of “◀” and “▶”, to move the position forward and backward by adjusting 5 levels.

Water pressure adjustment

During “REAR” or “FRONT”, press water pressure button of “+” and “-”, to adjust pressure for rear and front cleaning.

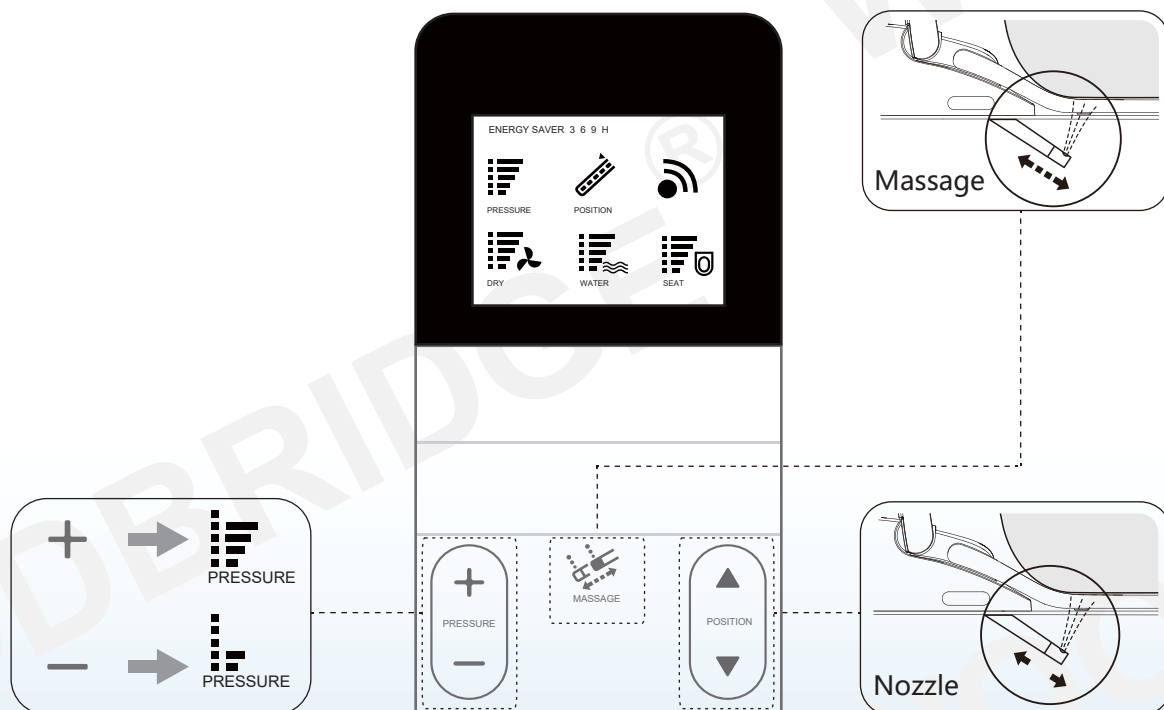

Usage Instruction

Energy saver

Setting energy saver time

Press “ENERGY SAVER” button, LCD screen shows energy saver and figures. It shows three options of energy saver period as 3-6-9-off, which can be selected accordingly. For example, user can set from 9:00 to 15:00 as energy saver according to following operation.

(1) Press “ENERGY SAVER” button, LCD screen shows “ENERGY SAVER” icon.

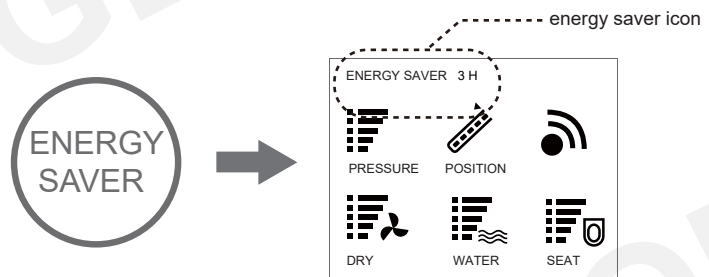

(2) Press “ENERGY SAVER” button again, LCD screen shows figure “6”, and the “ENERGY SAVER” icon disappear after 3 seconds, the setting succeeds. The toilet enters the energy saver mode from 9:00 to 15:00 every day. During this period, power light is off, and the energy saver light is on. It goes back to normal operation mode after energy saver time.

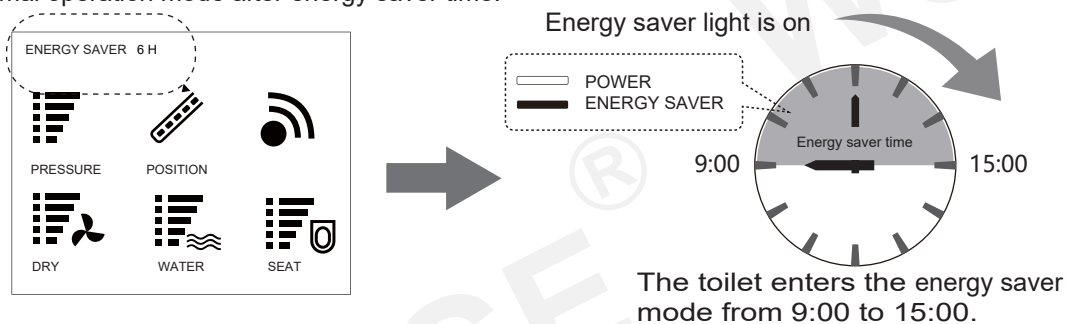

(3) Cancel energy saver set: Press “ENERGY SAVER” button continuously until this function is cancelled. (Nothing display on the screen.)

Energy saver:

The toilet will be under energy saver mode automatically after setting. Under energy saver mode, seat temperature is on low temperature status (first level) to achieve energy saver.

Notice:

If user sits on the seat, the energy saver mode is paused, and enters into the function mode, the seat starts to heat immediately (under opening seat temperature circumstance). The energy saver mode restores after user leaves.

When the energy saver mode is set, the icon disappears automatically, which is normal set.

Usage Instruction

Full flush (Only for the toilet with auto flush function)

Press "FLUSH" button to activate full flushing.

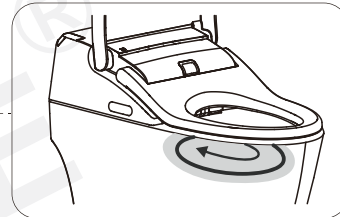

Nozzle cleaning

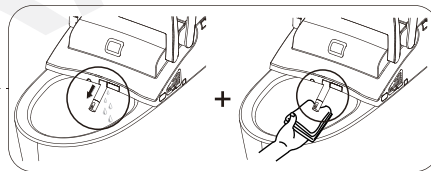

Nozzle self-cleaning by quick press:

Quick press "NOZZLE CLEANING" button, the nozzle self-cleans for a while and move to the front position (no spray). People can continue to clean nozzle manually.

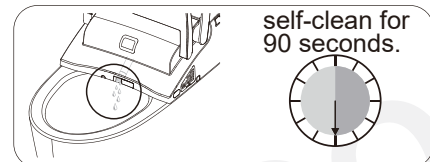

Nozzle self-cleaning by long press:

Long press "NOZZLE CLEANING" button, the spray won't move forward and nozzle self-cleans for 90 seconds.

Automatic deodorization (Only for the toilet with auto deodorization function)

Remark:

The deodorization function starts to work automatically as the user sits on the seat and stops automatically 3 seconds after the user leaves the seat. When drying, the function of automatic deodorization stops.

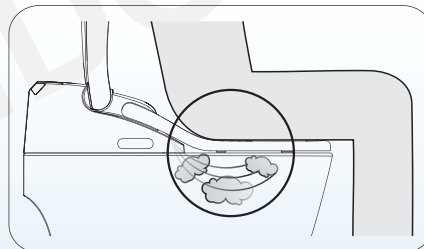

Usage Instruction

Temperature adjustment

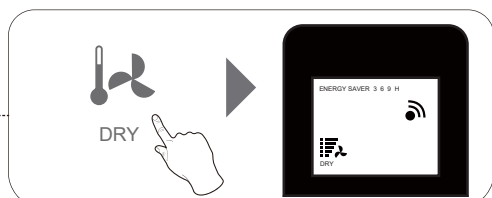

Dry temperature adjustment:

Press "DRY" button to adjust temperature for drying.
The LCD display of 1 to 5 lines means level 1 to 5. NO display means normal temperature. To adjust level by up and down cycle.

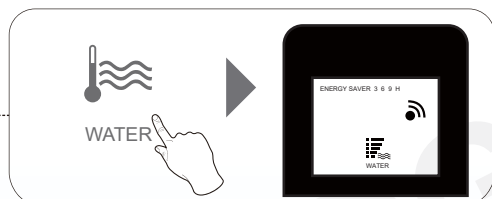

Water temperature adjustment:

Press "WATER" button to adjust temperature for rear and front cleaning.
The LCD display of 1 to 5 lines means level 1 to 5. NO display means normal temperature. To adjust level by up and down cycle.

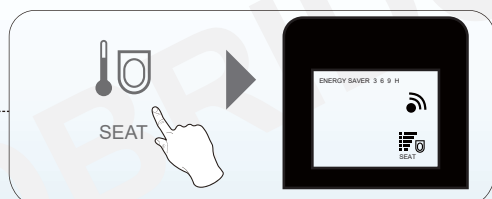

Seat temperature adjustment:

Press "SEAT" button to adjust temperature of seat. The LCD display of 1 to 5 lines means level 1 to 5. NO display means normal temperature. To adjust level by up and down cycle.

Usage Instruction

User code (Only for the toilet with User code function)

Long press "USER 1" or "USER 2" button to save the parameters, including current pressure, nozzle position, dry temperature, water temperature, seat temperature and massage status. Quick press "USER 1" or "USER 2" button to use saved parameter.

Hardware

configuration 1: Load settings user 1

Load settings user 2

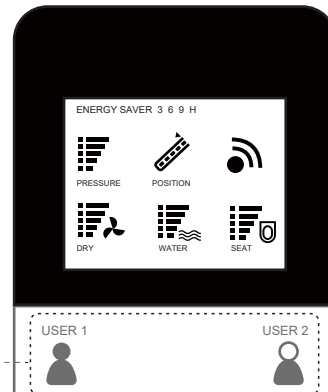

Hardware

configuration 2: Load & act male rear wash

Load & act female bidet wash

Hardware 1 support loading user settings only; hardware 2 support loading & acting user settings simultaneously. Remarks: Hardware 1 & 2 are matched with different smart seat/cover respectively. They do not coexist. Hardware 1 support V8100 series, and hardware 2 support all except V8100 series, generally for now. Configuration refer to factual product version and subject to change.

Auto lid open/close (Only for toilet with this function)

Press "☰" button to close seat cover.

Press "☷" button to open lid and close seat.

Press "☷☷" button to open lid and seat.

Lid close / seat close

Lid open / seat open

Lid open / seat close

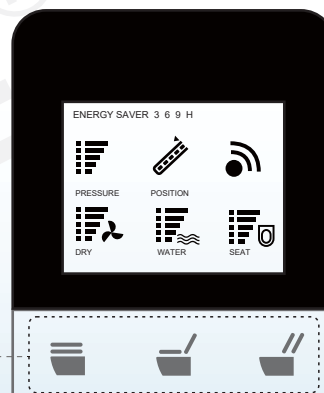
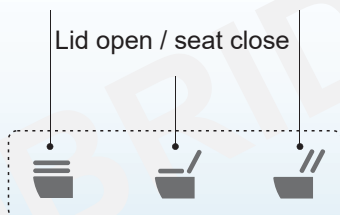

Usage Instruction

Auto function (Only for the toilet with auto flush function)

Full-automatic function can be achieved by three "AUTO" buttons, convenient and practical. User can pre-set the suitable nozzle position, water pressure and temperature and save the setting. Full-automatic function will be activated by pressing the related function button when using afterwards.

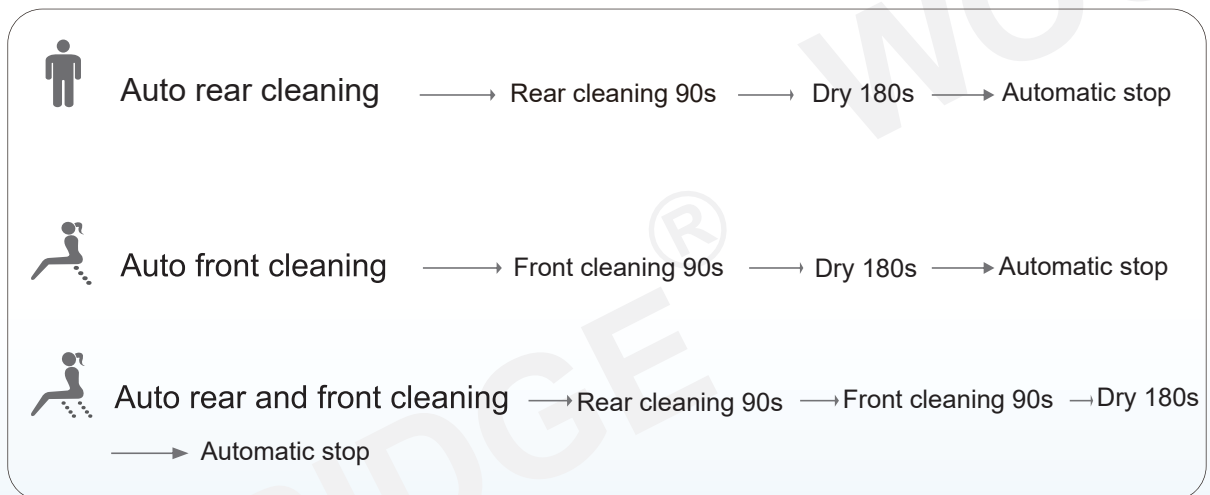
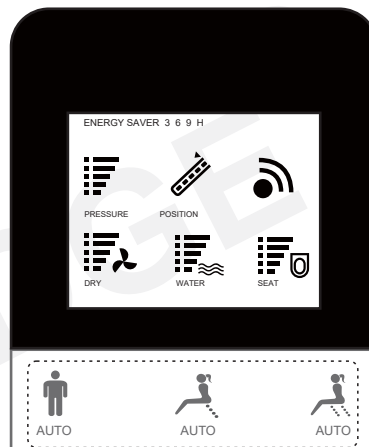

Usage Instruction

Combination button

Night light

Press "STOP" button, then "DRY" button, night light will be often in the off state; Repeat the process, night light will switch to intelligent state. Repeat above process constantly, the night light will switch between off state and intelligent state.

Quiet mode

Press "STOP" button and then "MASSAGE" button to turn off buzzer to avoid noise in the night; Repeat the process to start buzzer function.

User code

The user code needs to be set to avoid disturbance from remote controls when more than one toilets are used in the house. Turn on the toilet for setting while turn off others.

- (1) Press "STOP" button and then "REAR" button to enter into user code setting.
The remote control shows only water pressure and spray position level, and characters are blinking on the screen.
- (2) Press water pressure buttons of "+" and "-", to choose user code 1-9.
- (3) Press "STOP" button and then "REAR" button again, remote control will save the setting and exit user code setting window, the buzzer will ring "click" to indicate successful setting.

The sum of water pressure and position level on LCD is the user code. Restart to clear the user code and re-set.

Automatic flush button

Press "STOP" button and then "FLUSH" button to start or close automatic flushing function. When the automatic flushing function is turned on, toilet will automatically flush after detecting user sitting for more than 6 seconds and leaving the seat for more than 3.5 seconds.

Auto open/close

Press "STOP" button, and then press "  " button, it is the mode of auto open/close. Repeat above action to stop this function. (This key combination is only for toilet seat with auto open/close function. The default setting of auto open/close is in the off state, so it needs to be turned on at the first-use.)

Remark:

By pressing the button, the signal indicator will flash which means the signal is sent out; Then the buzzer rings "click", which means the main unit receives the signal and executes the instruction. If the signal indicator doesn't flash, that means the button is not efficiently pressed and needed to be re-pressed. If the buzzer does not ring, that means the main unit doesn't receive the signal. Please regulate the remote control direction and re-press the button.

In case of power cut during wand's spray operation, the wand cannot go back to place, please wait until the power is reset. In case of a power cut for a long period, please push the wand softly back by hand. Do not push hard, to avoid damage to wand and electrical machine.

The body should touch the seat and the buzzer rings "click", which means functions of front cleaning, rear cleaning and drying are in operation. The nozzle will continue to spray for 1-2 seconds after user stands up during spray operation, so please press "STOP" button before standing up.

Use nozzle self-cleaning function after user leaves the seat. After cleaning, if user doesn't press "NOZZLE CLEANING" or "STOP" button, nozzle wand will go back after 10 minutes or user sits on the seat.

Set auto function

Set automatic Rear cleaning function

The default setting of automatic function is water pressure on level three, nozzle position on level three, water temperature, wind temperature and seat temperature on level three, the massage function is in the off state. User can re-set based on personal preference.

(1) Adjust water pressure, nozzle position, temperature by function button in below grey circle, and open/close massage function.

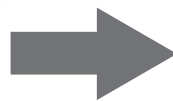
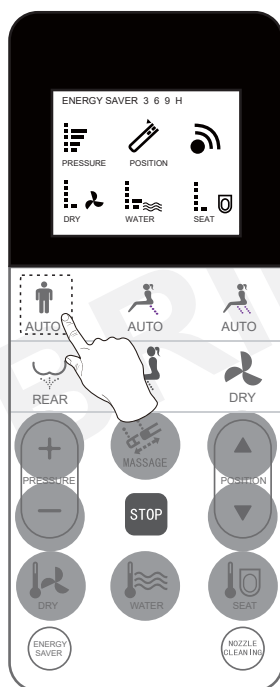

For example, the nozzle position is on level 2, and massage function is open; the water pressure is on level 4; water temperature is on level 2, while dry temperature and seat temperature are on level 1.

- (2) After setting is completed, long press rear cleaning automatic button for 3 seconds to save the setting.
- (3) After above steps, quick press “” afterwards when using, LCD displays the previous saved settings of rear cleaning level, temperature level and massage status. By this time, the toilet operates rear cleaning 90s, and then dry 180s automatically without pressing other buttons.
- (4) During automatic rear cleaning, user still can change the level, temperature and massage status, and press “REAR” button 3 seconds to save the new settings.

Set auto function

Set automatic Front cleaning function

- (1) Press spray nozzle position adjustment button to adjust nozzle to suitable position; Press “+”, “-” to adjust water pressure; set temperature level; open/close massage function.
- (2) Press “” front cleaning automatic button for 3 seconds, see below picture, and save the setting.

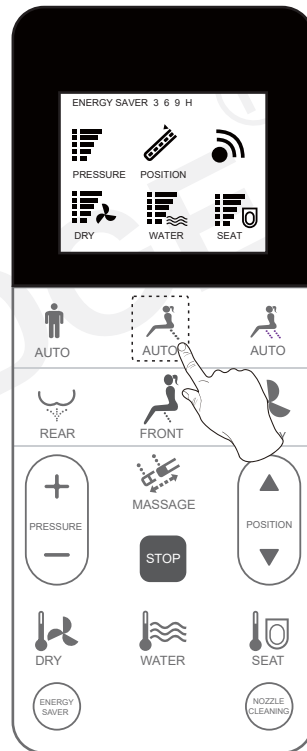

- (3) After above steps, quick press “” afterwards when using, LCD displays the previous saved settings of front cleaning level, temperature level and massage status. By this time, the toilet operates rear cleaning 90s, and then dry 180s automatically without pressing other buttons.
- (4) During automatic front cleaning, user still can change the level, temperature and massage status, and press “FRONT” button 3 seconds to save the new settings.

Set auto function

Set automatic Rear and Front cleaning combination function

Note: During using toilet, user can find the suitable level and temperature after comparing repeatedly. Please set the automatic Rear and Front cleaning combination function during using toilet.

The first stage: rear cleaning 90s

(1) Automatic Rear and Front cleaning combination function includes rear cleaning 90s, front cleaning 90s and drying 180s. User can adjust level and temperature in different stages.

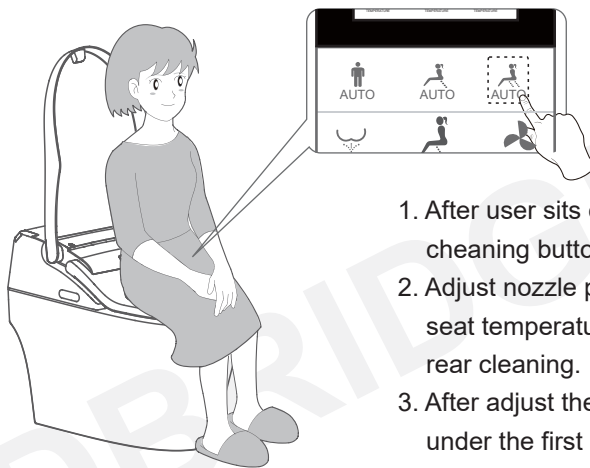

1. After user sits on the toilet, press automatic Rear and Front cleaning button, it starts to rear cleaning about 90s.
2. Adjust nozzle position, water pressure, wind temperature, seat temperature and open/close massage function during rear cleaning.
3. After adjust the parameters, remote control saves the parameters under the first stage.
4. During adjusting, if user adjusts many times, the remote control saves the latest parameter.

The second stage: front cleaning about 90s

(2) After finishing rear cleaning, toilet enters front cleaning stage automatically. User can set nozzle position, water pressure, temperature and open/close massage function, and the remote control saves the latest parameter under the second stage.

The third stage: Drying about 180s

(3) After finishing front cleaning, toilet enters drying stage automatically. User can set wind temperature, and the remote control saves the latest parameter under the third stage.

(4) After set all parameters, quick press "AUTO" button afterwards when using, LCD displays the previous saved settings. By this time, the toilet operates rear cleaning, front cleaning and drying automatically by one-button operation. If user needs to change previous settings, please repeat step 1-3.

Thank you for using WoodBridge products!

Customer Service Phone: 562-229-0088. (Monday - Friday 9 AM - 5 PM Pacific Time)

Or Email: help@woodbridgebath.com

www.woodbridgebath.com