

ASSEMBLY INSTRUCTIONS.

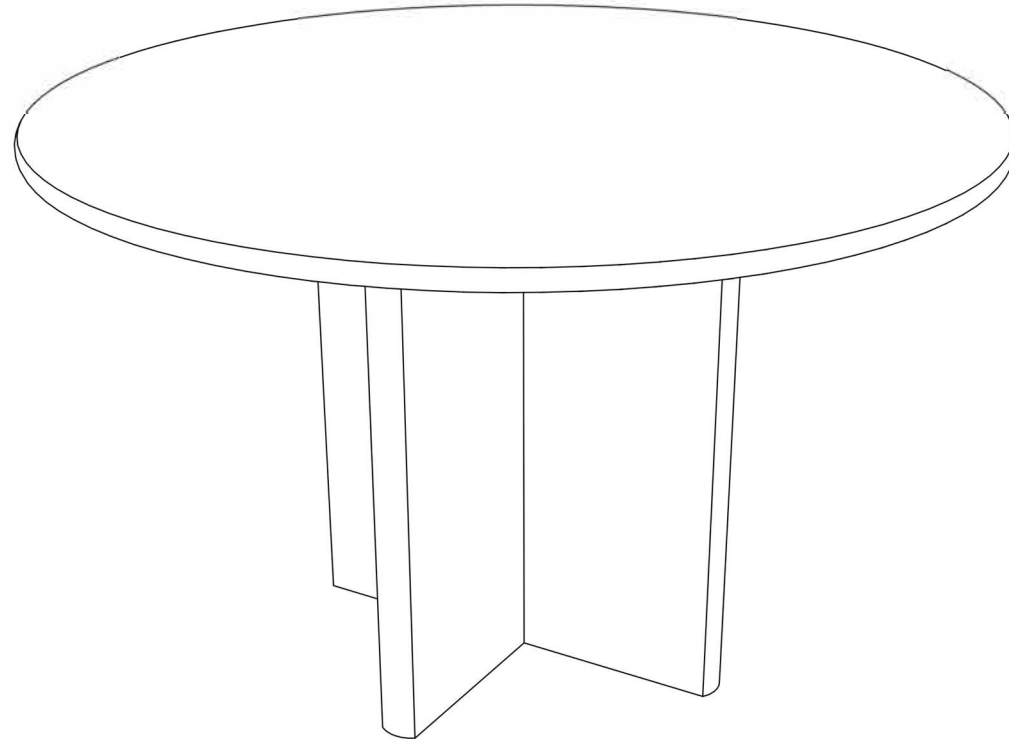

DINING TABLE





THANK YOU FOR YOUR PURCHASE!

PARTS AND HARDWARE.

PARTS LIST

| No. | DESCRIPTION | IMAGE | QTY |
|-----|-------------|---|-----|
| 1. | MARBLE TOP |  | 01 |
| 2. | BASE |  | 01 |

HARDWARE LIST

| No. | DESCRIPTION | IMAGE | QTY |
|-----|-------------|---|-----|
| 3. | ALLEN BOLT |  | 04 |
| 4. | ALLEN KEY |  | 01 |
| 5. | FLAT WASHER |  | 04 |

NOTES.

Thank you for purchasing this quality product! Be sure to check all packing material carefully for small part that may have come loose inside the carton during shipping.

CAUTION: The item is heavy, assembly should be performed by two people.

STEP 1.

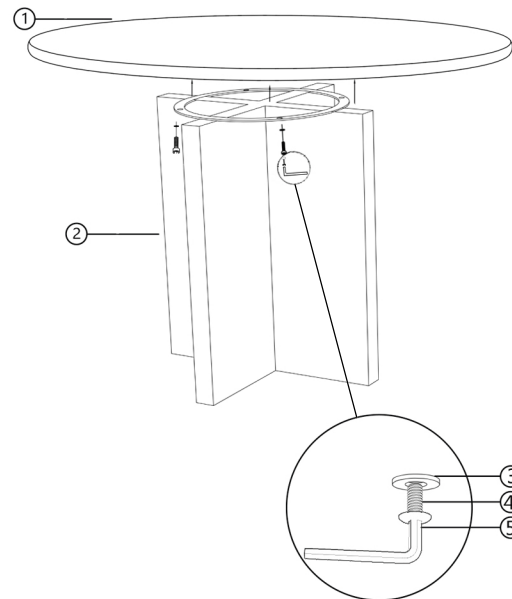

STEP 2.

