

Assembly Instructions

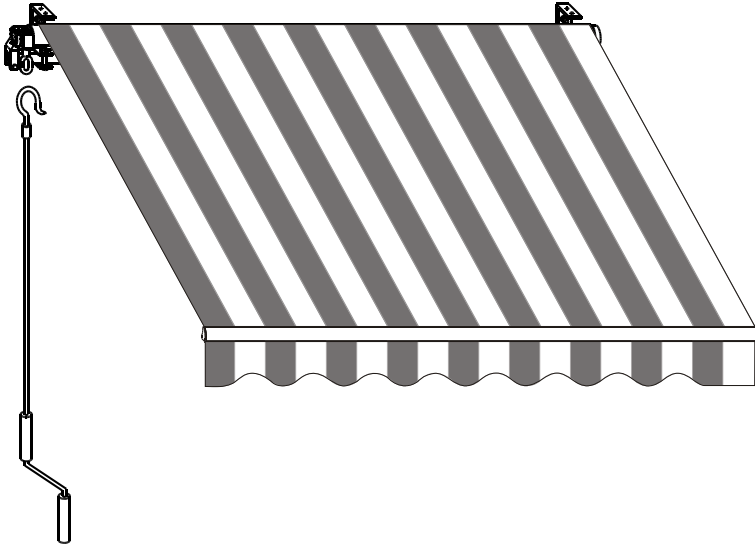

Content

Packing List.....	2
Product Description.....	2
Safety Instructions.....	3
Technical Data.....	4
Preparations.....	4
Mounting.....	5
Usage.....	9
Maintenance.....	10
Cleaning.....	10
Dismounting.....	11
Storage.....	11
Disposal.....	11
Manufacturer.....	11







Attention:

Read this instruction manual carefully and completely before mounting and usage. Keep this manual for future reference.

Packing List

You should find following parts in the package:

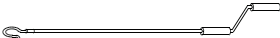
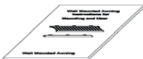
Part	Quantity	
	≤ 3.5m	3.5m ≤ 5.5m
 Awning	1	1
 Bracket with hexagon head bolt and locknut	2	3
 Screws Plastic bolt Washer	4	6
 Anchor with locknut, washer and locking ring	4	6
 Crank handle	1	1
 Instruction manual	1	1

Product Description

Retractable awnings are framework constructions that are mounted on building walls. The construction can be extended by a crank and is covered by a fabric shade that provides sun protection and visual cover. Your awning has been designed and developed to be used in private households, do not use it as rain shelter.

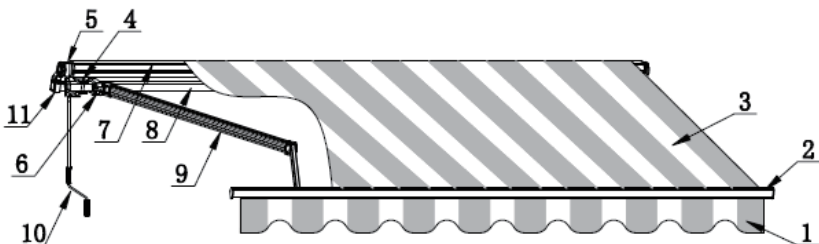

- | | | | | | |
|---|---------------------|---|--------------|----|----------------|
| 1 | Forefront of fabric | 5 | Gearbox | 9 | folding arm |
| 2 | Front bar | 6 | Arm shoulder | 10 | Crank handle |
| 3 | Fabric shade | 7 | Roller | 11 | Roller support |
| 4 | Bracket | 8 | Square tube | | |

Important Safety Instructions

Warning: For your own and the safety of other persons it is important to follow below instructions and obey warnings.

Symbol explanation



This warning triangle calls attention to hazards that that can lead to death or to severe injuries or which are important for the functioning of the awning.



This sign identifies important notes.

Safety instructions



To install this awning technical knowledge is necessary. Do not mount this awning yourself but contact a professional workman for help if

- ◆ you are unsure if the awning can be mounted on the place you chose for installation.
- ◆ you do not understand the instruction manual or parts of it.
- ◆ you do not have necessary tools available.
- ◆ you do not have necessary technical knowledge



A minimum of two healthy adults are required to move and install the awning as the product is big and heavy. Do not try to install the awning alone. If the awning falls, it could cause serious injuries and damages! Contact an authorized assembler for help.



Do not install the awning when you find damage parts are that parts are missing. Contact your dealer.



Keep children and pets out of the working area during assembly and adjustments.



If your building has an exterior shell (such as insulation, double brick wall, brick facing), installation should be taken out by a professional.



Nobody is allowed to change the products' design and structure without the permission of manufacture or authorized deputy.



Please make sure that your hands are clean at the time of the assembly; otherwise you may soil the awning fabric and frame.



The operation in frosty conditions may damage the awning.



The operation in snowy conditions may damage the awning.



In case of rain retract the awning if tilt angle is less than 14°.



Nobody is allowed to climb onto the awning. Hanging anything on the awning is forbidden.



Sheeting was used to protect the paint. This must be removed afterwards.



When extended, various forces, including wind and rain, will affect an awning. These sometimes substantial forces must be absorbed by the awning and transferred to the assembled structure via its mounting brackets. Under extreme loads, excessive attractive force can be exerted on the anchor bolts. Therefore, **before starting assembly, check the load-bearing capacity of the mounting base and if necessary take corresponding measures to ensure stable installation of the brackets.**

If the mounting base is unstable, you have to consult a specialist in your vicinity.

Technical Data

Model	SP1108 Series				
	2.5x2M	3x2.5M	3.5x2.5M	3.6x3M	4x3M
Adjusting angle	5-45°				
Gear ratio	1:7				
Wind resistance	Beaufort scale 4 (28km/h)				
Lifetime	5 years (assuming the frame is opening and closing twice a day)				
Recommended tilting angle	Min. 14° to the horizon in case of rain				

Preparations

Make sure that no children and pets are present during mounting. They could get hurt by lain out parts or tools.

Carefully remove the awning from the box and remove the styrofoam protectors from the awning. Remove the plastic bags and plastic guards from the awning and carefully place the awning aside to avoid having it damaged by scratches or otherwise damaged or soiled during assembly. Check the number of parts in the packaging whether the packing list requirements, the quality of parts availability issues, if questions, please contact the supplier.



Be aware the sudden extension may occur during unpacking.

Tools needed for assembly:

- ✓ Drill
- ✓ Masonry drill bit, 14 mm
- ✓ Level
- ✓ Wrench 14 mm, 17 mm and 19 mm
- ✓ Stepladder
- ✓ Tape measure

✓ Chalk or marker pen

✓ Wooden hammer

Mounting



Mounting on a concrete or brick wall

The awnings must be installed at least at the height of 2.5 m only on a reinforced concrete wall or massive brickwork. Please ask professionals for help if you are not sure. If your building has an exterior shell (such as insulation, double brick wall, brick facing), installation should be taken out by a professional.

If the wall/brickwork shows cracks you have to consult a professional.



Make sure the wall/ceiling is plain, so that bracket seats solidly.



WARNING! Two healthy adults with technical knowledge are needed to move and install the awning.



For safe and smooth installation think about where you will be securing the awning to the wall before you start drilling holes.

Step 1: Chose Mounting Location

Ensure that you also take this drop height into account in your decision on where to install the awning. The drop angle can still be changed after assembly. The ideal drop angle, however, has already been set at the factory and may only be changed minimally.

We recommend that the awning front bar has a height of at least 2.5 m when it is fully extended – if your local conditions do not allow this you can mount the awning in lower position. The horizontal centre line through the lower drilling holes must be 60 cm higher than the axis of the front bar to meet the minimum tilt angle of 14°.

In the event you would like to mount it above a balcony door, you should leave a space of at least 20 cm above the door frame if there is enough space available above the door frame.

Figure 1:

When choosing mounting location you must take tilt angle into consideration.

We recommend that the awning front bar has a height of at least 2.5 m, total drop A must be at least 0,60 m.

At a height of front bar at 2,50 height of centre line through lower drilling holes is 3.10 m.

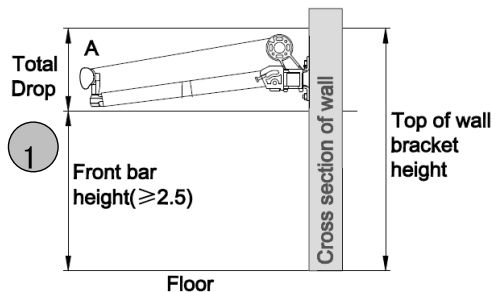

Step 2: Mark Drilling Holes

After choosing mounting position you can mark where you need to drill holes for the brackets.

Draw a horizontal line at the height of the required place. Use a long taper measure, a level and chalk.

We already marked where and with what width brackets need to be mounted. Measure the width between the brackets and copy it to the line on your wall/ceiling.

Hold a bracket with the lower mounting hole on the height for the chalk line to the wall (please refer to figure 5 for correct position of the bracket) and mark the two drilling holes. Use the bracket at centre mark template by running a marker pen through the holes of the brackets.

Alternatively you can use the packing to make a centre mark template. Just lay the awning inclusive brackets on the packing and mark the drilling holes. Then hold the template against the wall in corresponding height. Use a level.

Figure 2:

Mark drilling holes by using a chalk line to ensure that awning will be level after mounting.

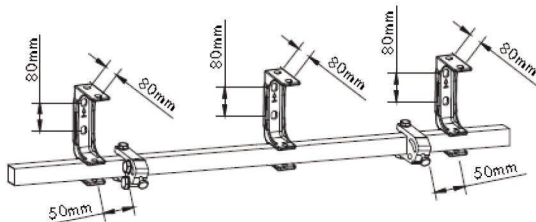
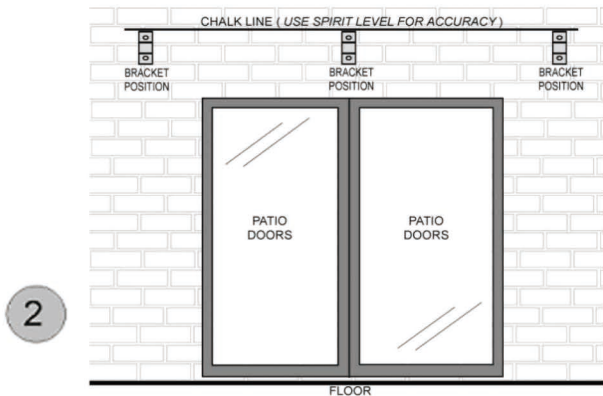

Step 3: Drill Holes

Use 14-mm masonry drill to drill the holes for the brackets at the appropriate marks on the wall. The holes should be 9 cm deep in the wall and must be drilled through solid masonry or concrete. Do not bore through mortar because this does not offer the strong enough support for the heavy duty anchors, which are required for the installation of awning.

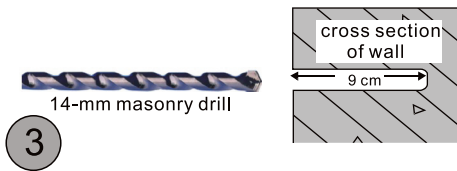

Figure 3:
Use 14-mm masonry drill to drill 9 cm deep holes.

Step 4: Insert Heavy Duty Anchors

After drilling, clean the holes by blowing them out. Then insert the heavy duty anchors into the holes.

Before inserting lose the nut, washer and clamp ring. Put them at the side, so that you have it at your fingertips.



It may be necessary to drive in the anchor bolts with a wooden hammer because they do not go in easily. First loosely screw a nut on the screw of the heavy duty anchor. Screw the nut to the outer metal edge of the heavy duty anchor, make sure the nut loose so that the cone on the back cannot be pulled into the metal jacket and spread it. Now, the power of impact will also be effective to the jacket, so that not only the cone will not be pushed out of the anchor, but that the jacket will be moved into the hole too. Only use light impact to drive the heavy duty anchor into the wall. Caution: To hart impacts might damage the heavy duty anchor! If you have doubts pull out the anchor and drill the hole again, but do not make it bigger.



Attention: If you find that there is no resistance when you pull out the nut of the heavy duty anchor, then the heavy duty anchor has not enough anchorage. You have to repeat the complete mounting with a minimum offset of 15 cm!



For correct mounting jacket of heavy duty anchor must be inserted completely, it may not overlap! If necessary remove the anchor and drill the hole deeper.

Figure 4:

Insert heavy duty anchors as shown into the drilling holes.

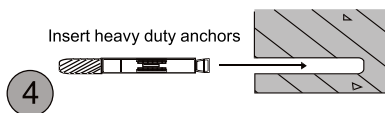

Step 5: Fixing the brackets

Place the bracket on the screw protruding from the wall. Then add flat washer and spring washer and fix the bracket with lock nuts. Tighten them well.

It is also possible to fix the awning under a concrete ceiling. If you want to fix the awning under a concrete ceiling you must consult a professional expert for this kind of mounting.

Figure 5:
Bracket has been prepared to be fixed on a wall. Chose the whole you need to fix them according to drawing.

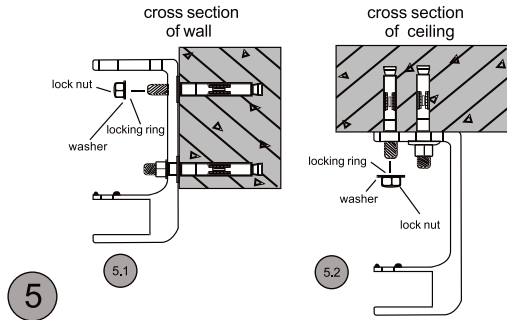

Firmly tighten the bolts with a 17mm wrench: use an angulated ring spanner or better a socket wrench with proper socket. Open-ended spanners or fork wrenches should not be used, because of possible danger of slipping or damage of the nuts.



As soon as they are fully inserted, the brackets must sit firmly in the wall. If they are still moving in any form, you must further tighten it.



Do not try to secure the wall brackets to loose wall stones or any surfaces that are not absolutely firm connected to brickwork.



Make sure that brackets have been attached to wall firmly, so that they cannot be pulled out when hanging on the awning.

Step 6: Install awning

After all two brackets have been mounted properly you can fix the awning. At least two ladders or treads are required to install the awning in order to obtain the required height. Ensure that the ladders/treads are firmly resting on the ground so that you cannot fall. Only use ladders/treads that are suitable for such assembly work.

Insert the awning into brackets as shown in drawing below. Then immediately secure it with delivered round head bolts to the brackets. Tighten the nut of the round head bolt firmly.

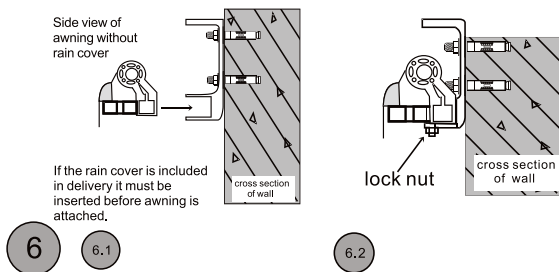

Figure 6:

Insert awning to bracket as shown in 6.1. Fix the awning with delivered safety screw, flat washer and nut (6.2) and tighten it properly.



In case the square tube cannot be inserted into the wall brackets, slightly loosen the nuts of the heavy duty anchor for one bracket and then try it once again. This time, move the awning slightly forward and backwards until the bearing tube slips into the brackets. Then immediately tighten the nuts of the heavy duty anchors by using a 17 mm hex key.

Attention: You have to tighten the nuts at the brackets after awning as been installed to brackets.



Remove the safety belt after mounting; otherwise the awning cannot be extracted. Keep the belt; you can use it when storing the awing.



Attention: Misplacing and misapplying the awning can cause seriously danger. Only mount the awning yourself when you understand the mounting instructions completely and when you are sure that the wall you want to mount the awning on is suitable. For your own and the safety of other people please contact an authorized assembler for help.

Usage

Adjusting Tilt Angle

The awning is already delivered with an optimally adjusted tilt angle. However, users can adjust the screen angle within a range of 15° to 45°. A tilt angle smaller than 15° is not allowed – although the construction of the adjustment mechanisms would allow having a smaller angle.



Once the adjustment screw reaches its end position you may not turn it further. Do not force it! Disobeying this instruction can lead to damage on the awning that can cause hazard and void the warranty!

Extend the awning no more than 1/4 of its full projection before adjusting.

Figure 7:

Users may adjust the screen angle within a range of 15° to 45°.

Take off the plastic caps; loosen the safety nuts with a 17mm wrench.

Turn the adjusting screw clockwise to decrease the tilt angle; turn counter-clockwise to increase the tilt angle.

When achieved to the desired tilt angle, tighten the safety nuts and put the plastic caps back on it (7.2).

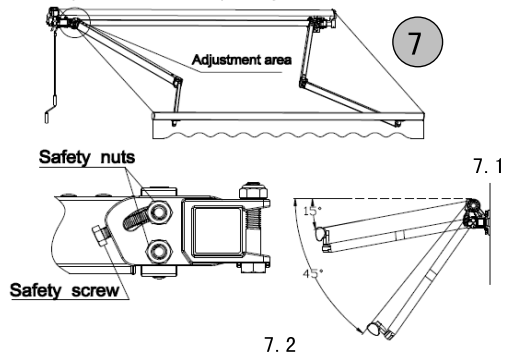

Follow the same procedure until all arms have been adjusted to the desired level.



The front bar must always be level. To ensure that both sides are completely level, a built-in level is located on the front bar: the air bubble must be exactly in the middle of the level.



Place the plastic caps on the screws to protect them against weather based corrosion.



Take out the crank handle from loop after adjusting the awning as you wish and put it on a place that is not reachable for children to avoid that they play with the awning.

Extend and retract the awning

The awning can be extended and retracted by a crank handle included in delivery.

Figure 8:

Insert the handle in the loop that is fixed at the awning. Open the awning by turning the crank handle clockwise. By turning it counter-clockwise you can retract the awning.

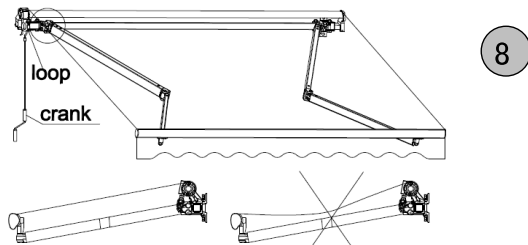



The awnings are intended as a protection against the sun only. It is not to be used during periods of strong wind, rain, hail, or snow. In case of such conditions, retract the awning immediately.



Never allow children to play with the awning.



Be sure the fabric is tensioned. If the fabric is not tensioned during extension, please turn counter-clockwise until the fabric is tensioned.



Do not put any objects or parts of your body e. g. hands, in the awning while extending and retracting. Hazard of crush!



When the front bar touches the roller as shown in following figure during retraction, don't try to make them closer, otherwise the product might be damaged.



To avoid sudden extension of the awning during extend or retract it, make sure that no other people is standing near the awning during the operation.

Maintenance

Regular maintenance will not only help to keep a long durability but is also important for your own and the safety of other people.

- ◆ Examine regularly if wall brackets are tight, fasten them if loose or lax.
- ◆ Examine the gear box once in half a year. If you find any damages stop using the awning until gear box has been repaired or renewed.
- ◆ Examine the bolts and nuts once in half a year, fasten them if loose or lax.
- ◆ Stop using the awning immediately if it has been damaged or it is not tightened properly.

Please contact an authorized service centre for repair and if you have any further questions.

Normally it is not necessary to lubricate moving parts of the awning. However, if it will be necessary on day, e. g. because of abnormal noise or because extracting is difficult, do only use lubricants that can be used for plastic materials, do not use lubricants that are based on petroleum.

Use a straw attached to the spray nozzle. Lubricate generously the area between the end of the roller tube and the end bracket (pivot pin). Take care not to overspray on the fabric material.

Cleaning

Frame: Over time, dust and dirt will collect on the frame and will require periodic cleaning to maintain its appearance.

A mild spray cleaner or water/detergent mixture may be applied to the frame to clean it. Wipe dust off with a damp cloth. Do not use aggressive detergents e. g. to clean oil residues.

Fabric: Clean the fabric every six months.

Only use natural soap, never use chemical detergents. Water should be cold to lukewarm. Let the fabric dry completely. Do not use heating appliances e. g. hairdryer for drying.

Dismounting

When you don't want to use the awning anymore or if you want to dispose it one day you have to demount it.

Attention! At least two healthy adults are need for this step.

- ◆ Retract the awning completely before you begin with dismounting. Bind the arms of the awning together to avoid unintended unfolding. This might cause damage and injury. You can use the protection band that was fixed on the awning when purchasing it.
- ◆ Follow the mounting instructions in reversed order to dismount the awning.
- ◆ Make sure that drilling holes in the wall will be sealed professional.

Attention! Safety hints and instructions have to be followed for dismounting as well.

Storage

When you do not want to use the awning for a longer period of time it is recommended to take the awning out of the brackets and store it.

- ◆ Make sure that the fabric is dry completely before storing. Storing a wet fabric can cause spots and damage.
- ◆ Store the awning at a dry and safe place that is not reachable for children.

Disposal

Do not dispose this awning with other household wastes. To prevent possible harm to the environment or human health from uncontrolled waste disposal, recycle it responsibly to promote the sustainable reuse of material resources. To return your used device, please use the return and collection systems or contact the retailer where the product was purchased. They can take this product for environmental safe recycling. Dispose packing materials according to local guidelines.