



# ZAER LTD. INTERNATIONAL











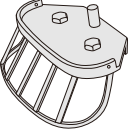
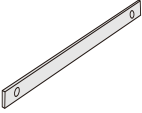
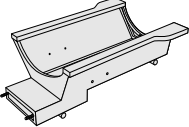

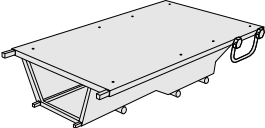
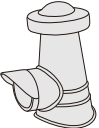
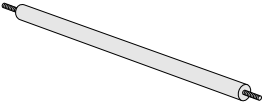
## ASSEMBLY INSTRUCTIONS

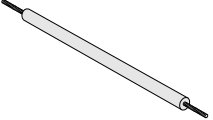
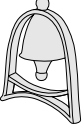

### ITEM NO.: ZR200555 5.85 ft. Long Medium Iron Christmas Train with Cart & Lanterns "Blessed Bullet"

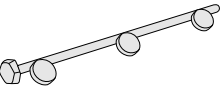
Please read instructions thoroughly before assembling this product. Familiarize yourself with inventory of parts and the accompanying illustrations to ensure safe and proper assembly.

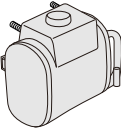
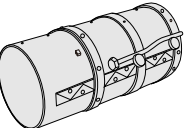
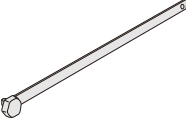
### PARTS LIST

Part	Picture	Qty	Description	Part	Picture	Qty	Description
A1		1	BOTTOM 1	K2		2	SHORT CONNECTING ROD
B2		1	BOTTOM 2	L3		2	FOOT STEP
C3		1	BOTTOM 3	M4		1	CHIMNEY WITH LIGHT
D4		3	AXLE 1	N5		1	CHIMNEY 1
E5		2	AXLE 2	O6		1	BELL
F6		6	SMALL WHEEL	P7		1	CHIMNEY 2
G7		4	BIG WHEEL	Q8		2	PIPE
H8		4	WHEEL COVER	R9		1	BOILER PART 1
I9		2	CYLINDER	S1		1	BOILER PART 2
J1		2	LONG CONNECTING ROD	T2		4	LANTERN



# ZAER LTD. INTERNATIONAL







## ASSEMBLY INSTRUCTIONS

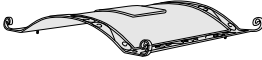
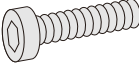
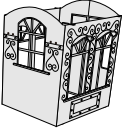
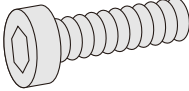
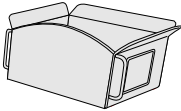
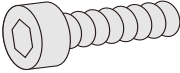
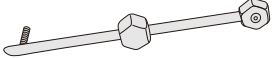

### ZR200555 5.85 ft. Long Medium Iron Christmas Train with Cart & Lanterns "Blessed Bullet"

Please read instructions thoroughly before assembling this product. Familiarize yourself with inventory of parts and the accompanying illustrations to ensure safe and proper assembly.

#### PARTS LIST

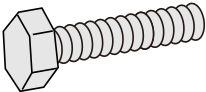
Part	Picture	Qty	Description	Part	Picture	Qty	Description
U3		1	CARRIAGE TOP	D3		2	SCREW Φ6mm x 35mm
V4		1	CARRIAGE	E4		1	SCREW Φ6mm x 20mm
W5		1	CART	F5		14	SCREW Φ6mm x 15mm
H7		2	SUPPORT FOR BOILER	G6		2	SPACER Φ18mm
X6		10	NUT Φ8mm				
Y7		2	NUT Φ6mm				
Z8		12	NUT Φ5mm				
A9		2	NUT Φ8mm				
B1		16	NUT Φ6mm				
C2		5	SCREW Φ8mm x 35mm				



# ZAER LTD. INTERNATIONAL ASSEMBLY INSTRUCTIONS



ZR200555 5.85 ft. Long Medium Iron Christmas Train with Cart & Lanterns "Blessed Bullet"

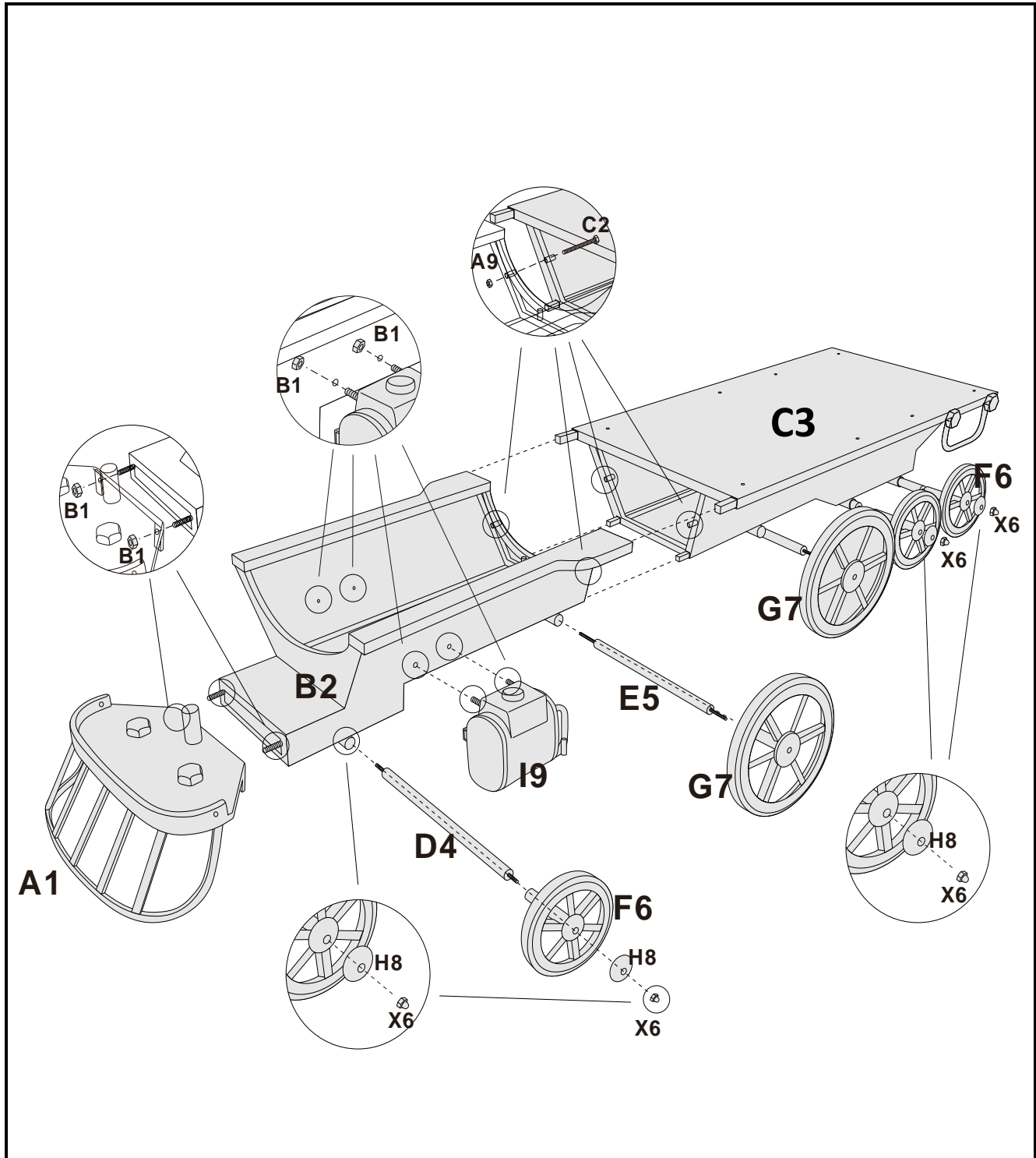

**STEP 1:** Locate **Bottom Pieces 1-3 (A1/B2/C3)** and connect together with specific **Nuts/Screws (B1/A9/C2)**. Assemble **ALL Wheels (F6/G7)** to the **five Axles 1-2 (D4/E5)** and then lock **Wheel Covers (H8)** but **ONLY** to the **Small Wheels (F6)** using provided **Nuts (X6)**. Locate **two Cylinders (I9)** and attach them to **Bottom 2 (B2)** using corresponding **Nuts (B1)**.



# ZAER LTD. INTERNATIONAL ASSEMBLY INSTRUCTIONS



**ZR200555 5.85 ft. Long Medium Iron Christmas Train with Cart & Lanterns "Blessed Bullet"**

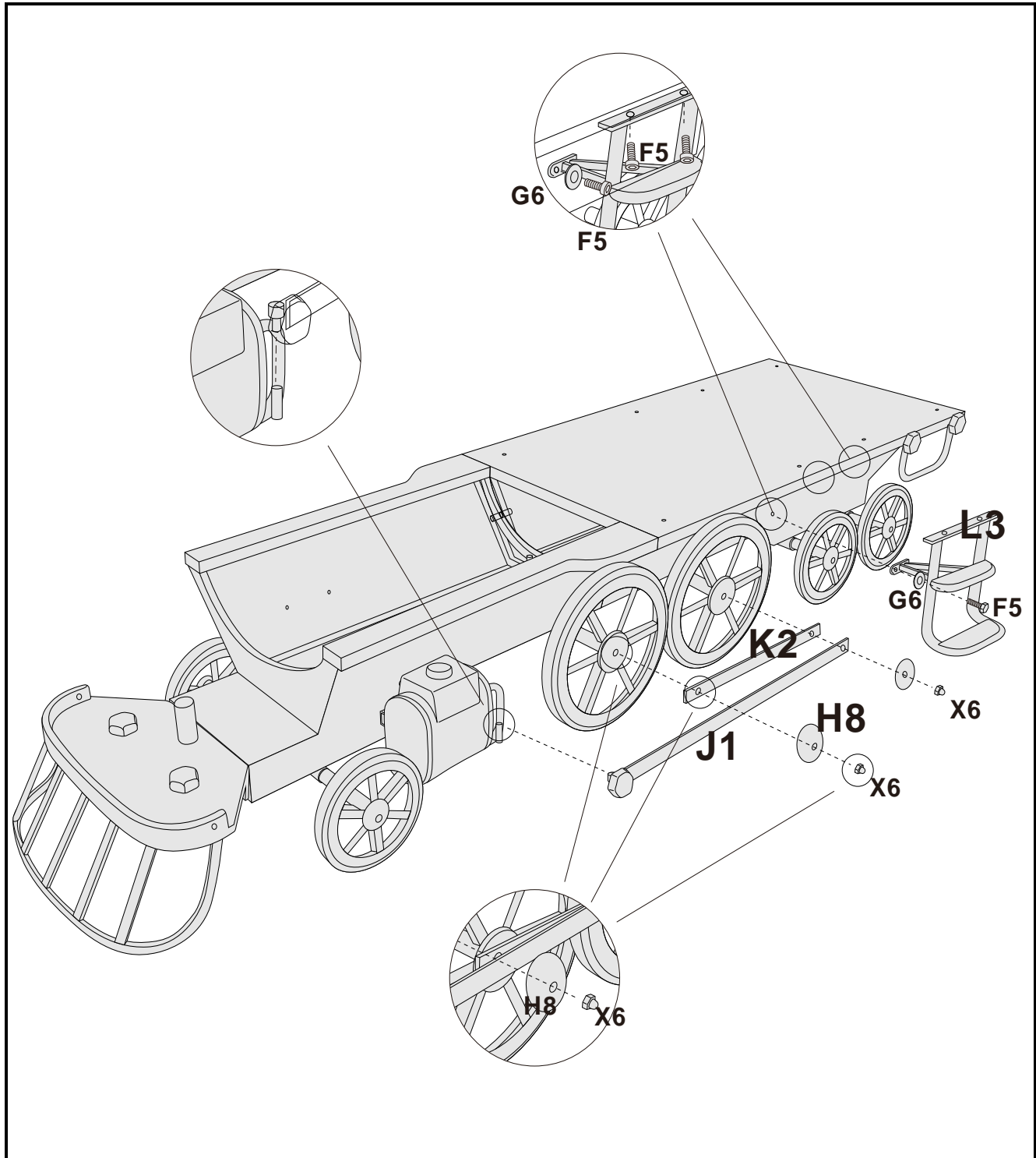

**STEP 2:** Locate **Long and Short Connecting Rods (J1/K2)** and connect to **Big Wheels (G7)**. Then lock in place with the **Wheel Cover (H8)** and corresponding **Nut s(X6)**. Locate **Foot Steps (L3)** and attach them to the **Bottom Part** created in **STEP 1** (*specifically C3*) with **Spacer (G6)** and **Screw (F5)**.



# ZAER LTD. INTERNATIONAL ASSEMBLY INSTRUCTIONS



ZR200555 5.85 ft. Long Medium Iron Christmas Train with Cart & Lanterns "Blessed Bullet"

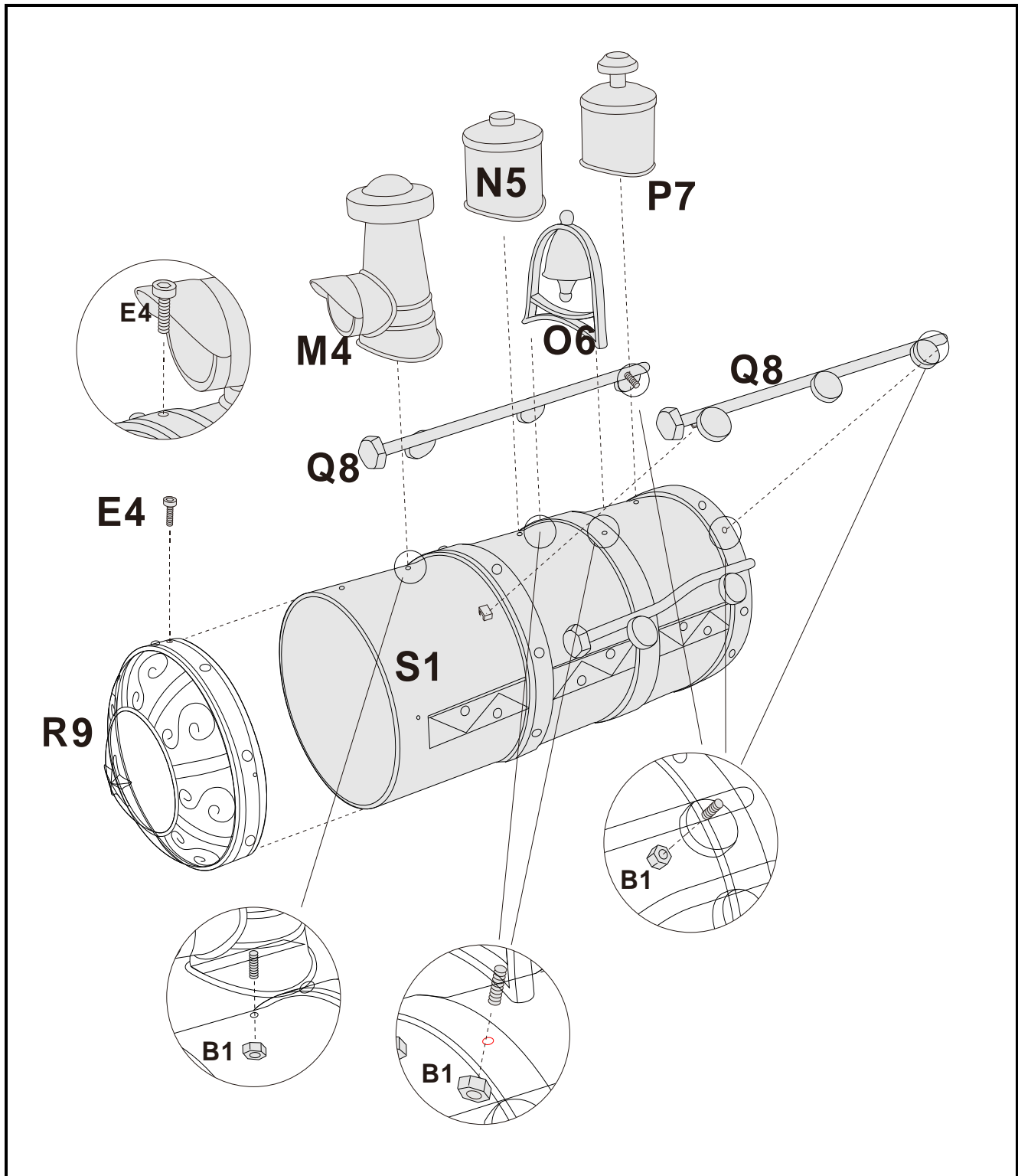

**STEP 3:** Locate **train accessories (M4/N5/O6/P7/Q8)** and attach them to **Boiler Part 2 (S1)**, fastening with **Nuts (B1)** inside the **Boiler (S1)**. Then fix **Boiler Part 1 (R9)** to **Boiler Part 2 (S1)** with specific **Screws (E4)**.



# ZAER LTD. INTERNATIONAL ASSEMBLY INSTRUCTIONS



**ZR200555 5.85 ft. Long Medium Iron Christmas Train with Cart & Lanterns "Blessed Bullet"**

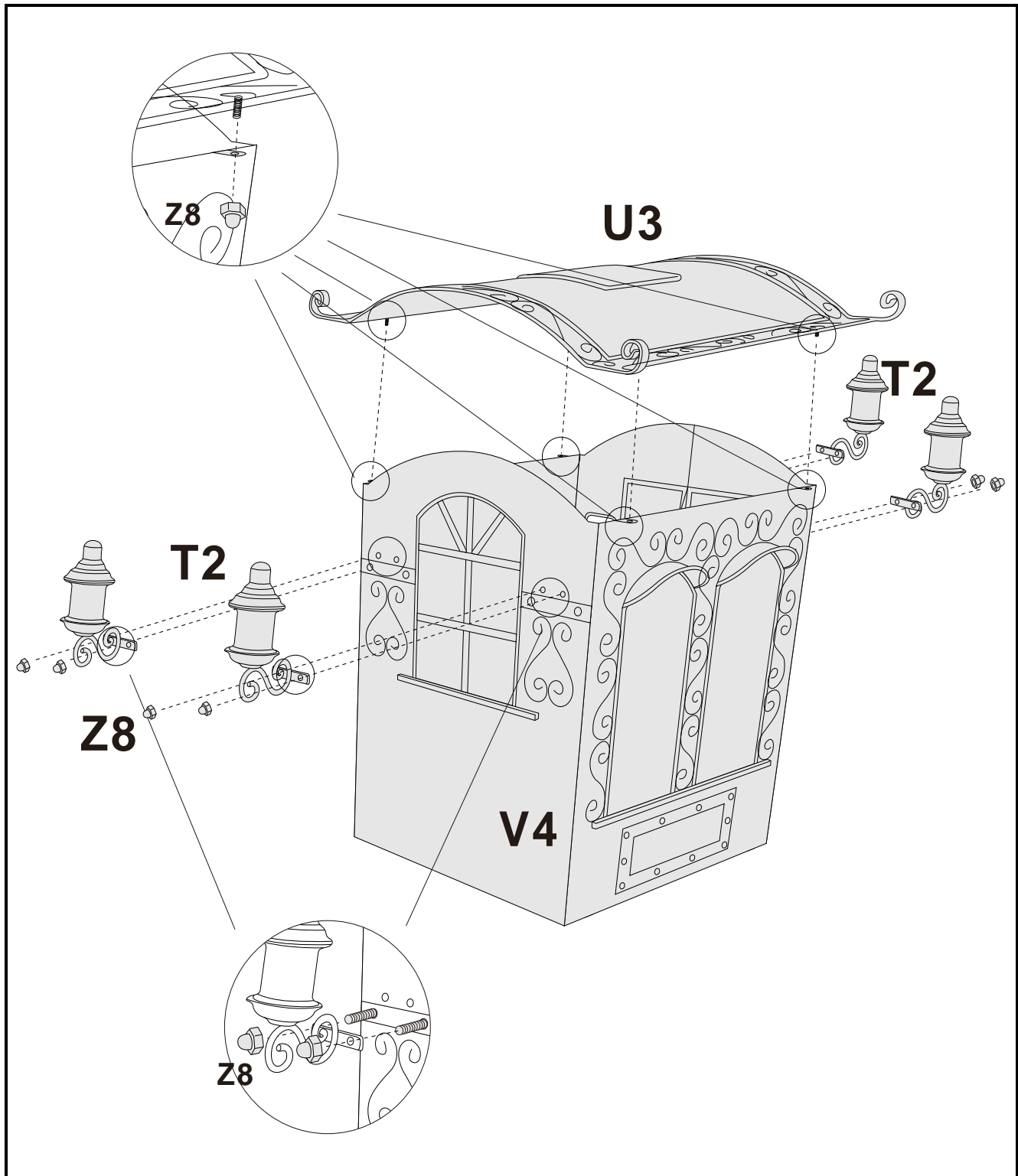

**STEP 4:** Locate and assemble the **Carriage (V4)** by attaching the **Carriage Top (U3)** with **Nuts (Z8)**. Locate **four Lanterns (T2)** and attach to the recently assembled **Carriage (V4/U3)** with same **Nuts (Z8)**.



# ZAER LTD. INTERNATIONAL ASSEMBLY INSTRUCTIONS



ZR200555 5.85 ft. Long Medium Iron Christmas Train with Cart & Lanterns "Blessed Bullet"

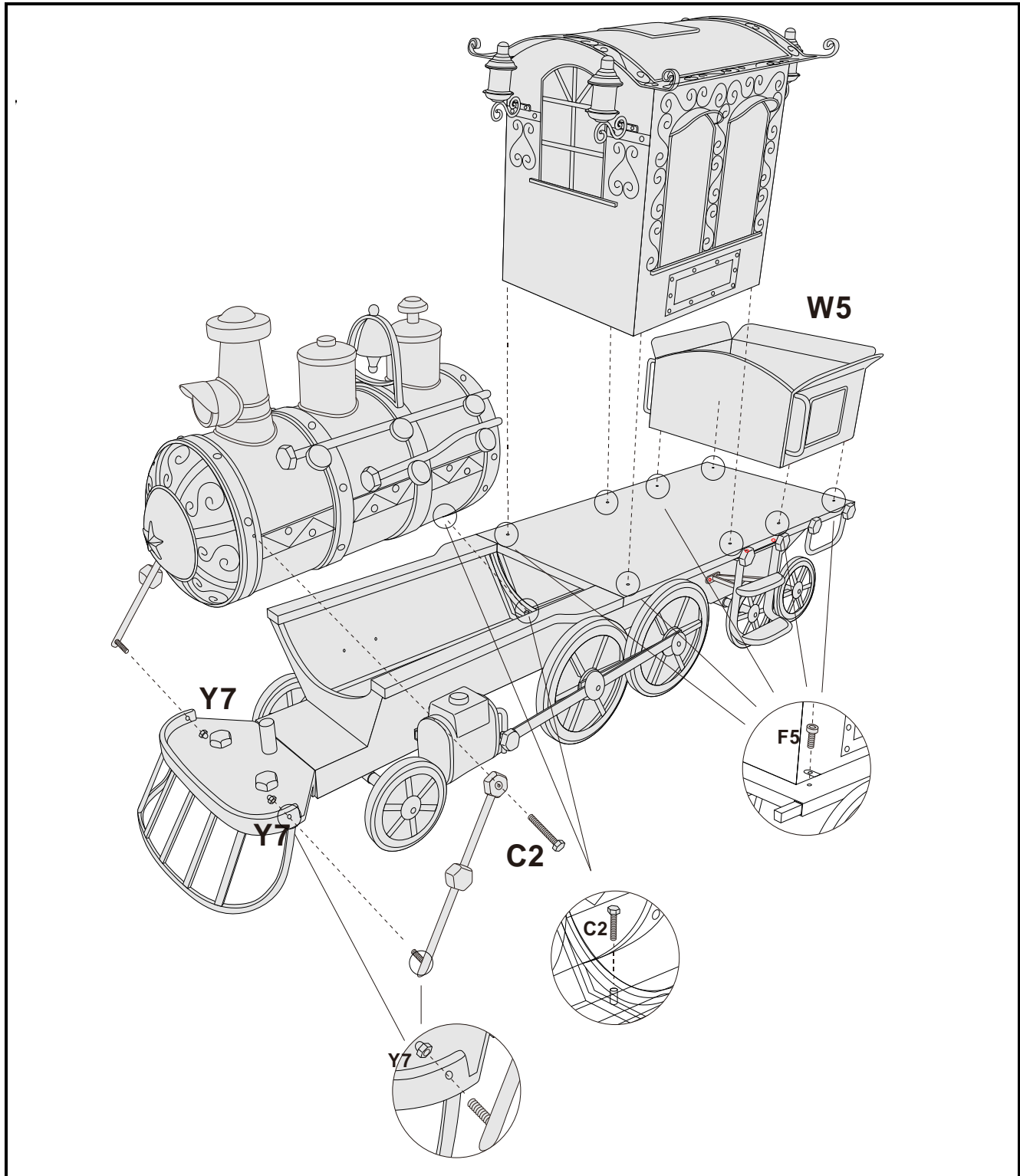

**STEP 5:** Take the **Boiler** from **STEP 3**, **Carriage** from **STEP 4**, and **Cart (W5)** and set on top of the **Bottom** from **STEP 1-2**, fastening in place with specific **Screws (C2/F5)**. Lock **Support for Boiler (H7)** with **Screw (C2)** and **Nuts (Y7)**.



# ZAER LTD. INTERNATIONAL ASSEMBLY INSTRUCTIONS



**ZR200555 5.85 ft. Long Medium Iron Christmas Train with Cart & Lanterns "Blessed Bullet"**

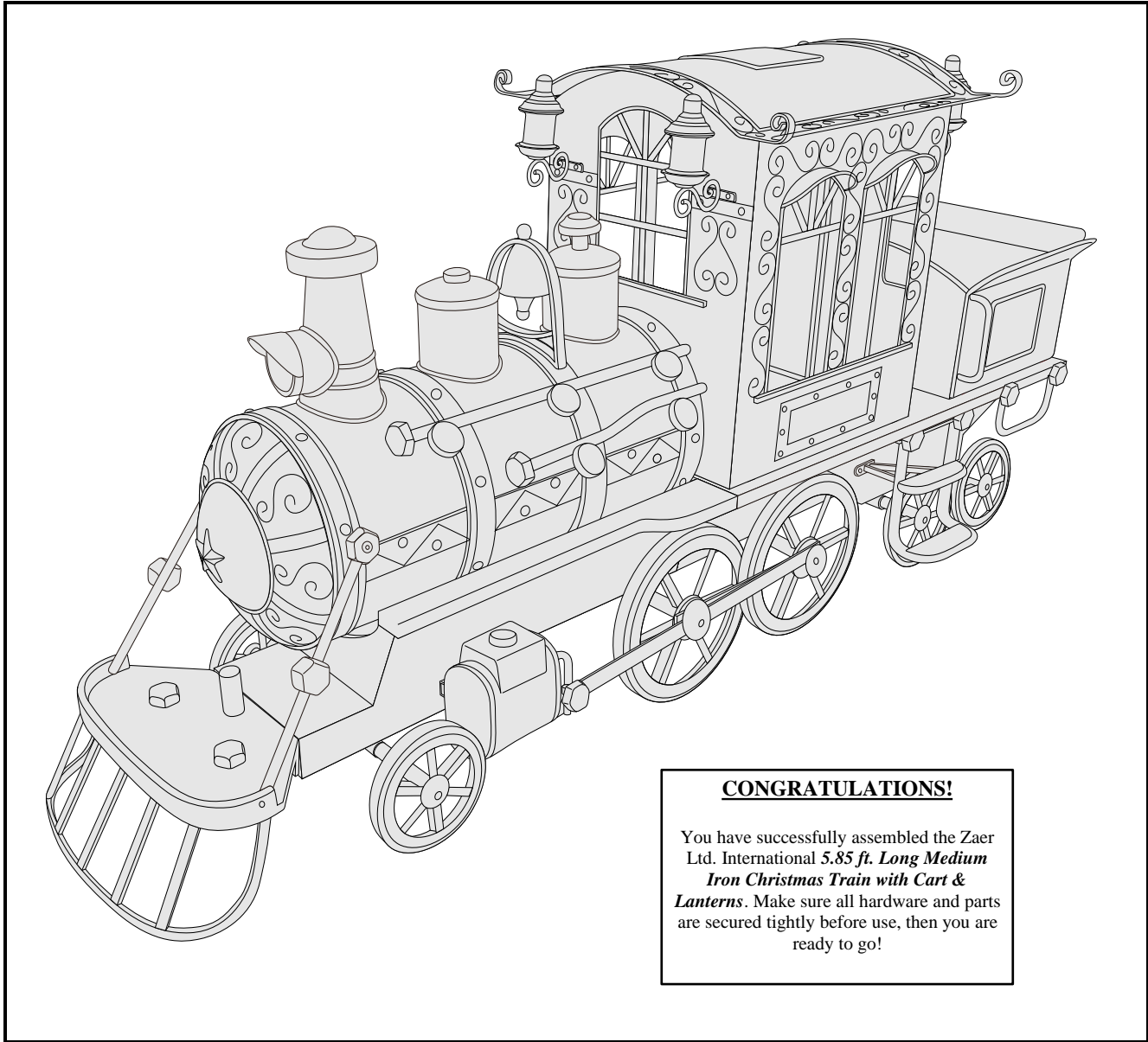

**CONGRATULATIONS!**

You have successfully assembled the Zaer Ltd. International **5.85 ft. Long Medium Iron Christmas Train with Cart & Lanterns**. Make sure all hardware and parts are secured tightly before use, then you are ready to go!

**IMPORTANT: Check all hardware for tightness before and during use**  
 This assembly requires **TWO (2) people** and will take approximately **THIRTY (30) minutes** to complete.

**Use and Care:**

Safe for both indoor and outdoor use; year round. Clean with damp/dry cloth; use clear protective overspray (ex. Rustoleum, Tractor Finish) before use and every 6 months after for added protection against potential fading and/or weatherization.

**Zaer Ltd. International Warranty**

Zaer Ltd. products have a 30 day warranty that begins once product is delivered. Questions/Comments: Call 215-766-2010 or email sales@zaerltd.com.

Visit [www.ZaerLTD.com](http://www.ZaerLTD.com) to shop our entire selection of wholesale home & garden decor!



*\*Not a retailer/wholesale buyer?*

Head over to [www.Lesera.com](http://www.Lesera.com) for Zaer Ltd. products available direct to consumer!

Follow both Zaer Ltd. (Wholesale) and Lesera (Retail) on Social Media:

Zaer Ltd. Facebook/Instagram: [@zaerltdinternational](#)

Lesera Facebook/Instagram: [@leserahg](#)

