

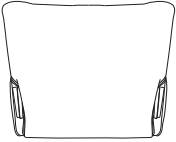





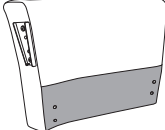
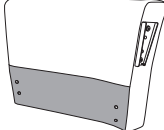

## **USER MANUAL** **Leisure Sofa**

**Attention:** This instruction contains important safety information, Please carefully read it and keep it for future reference.

# Parts List Make sure all the parts are in the package

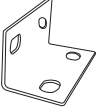
① x1pc  Backrest	② x1pc  Seat frame	③ x1pc  Left Armrest	④ x1pc  Right Armrest	⑤ x2pcs  Front Leg	⑥ x2pcs  Rear Leg	
--	---	---	--	--	--	--

## Erecting Tools

A x4pcs 	B x16pcs M8 X 30mm 	C x4pcs 	D x1pc 			
--	--	--	---	--	--	--

## Installation Steps



For the first time to install, Try not to install with 

### Step 1

Note: Look clearly towards the front indicator and towards the sheet metal screw hole

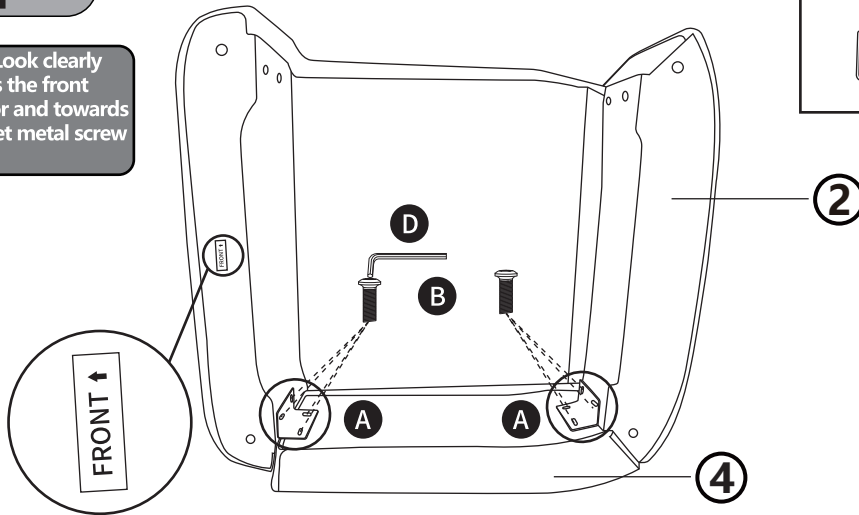

A x2pcs



B x8pcs



D x1pc



Note: Screw to 80%

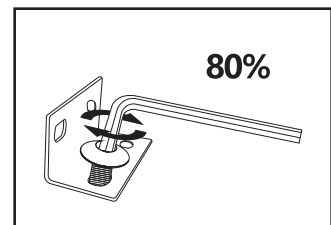

### Step 2

Note: Tighten all screws to 100% after full alignment

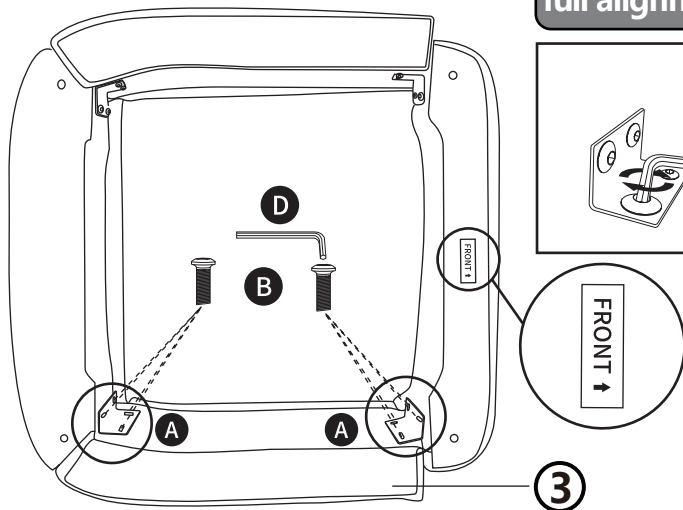

A x2pcs



B x8pcs



D x1pc



100%

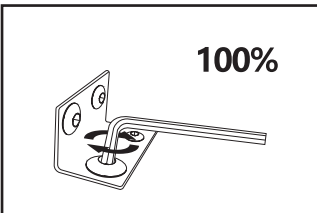

Note: The bottom of the backrest and armrest should be aligned at the same level

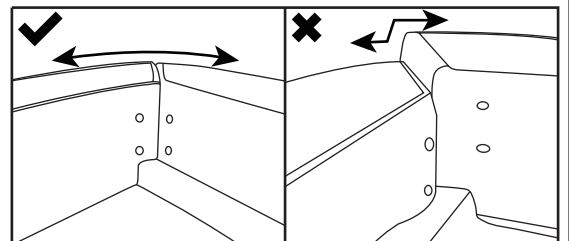

# Step 3

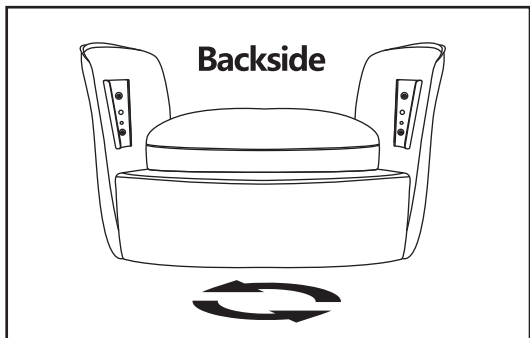

Note: Pay attention to the installation direction and press down on the back

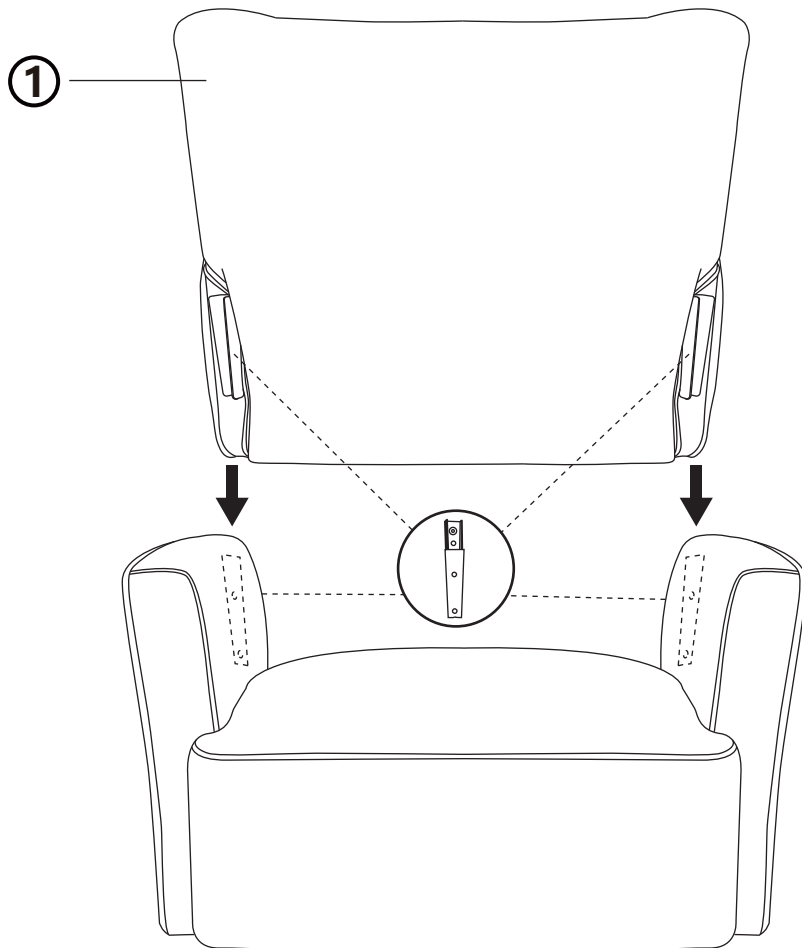
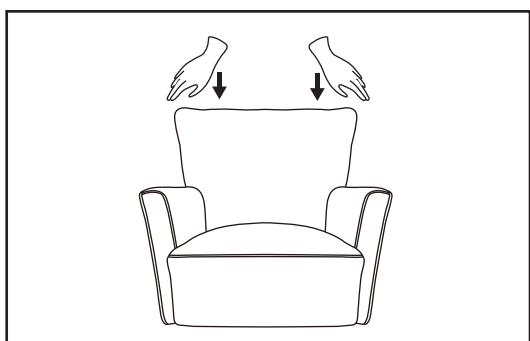

# Step 4

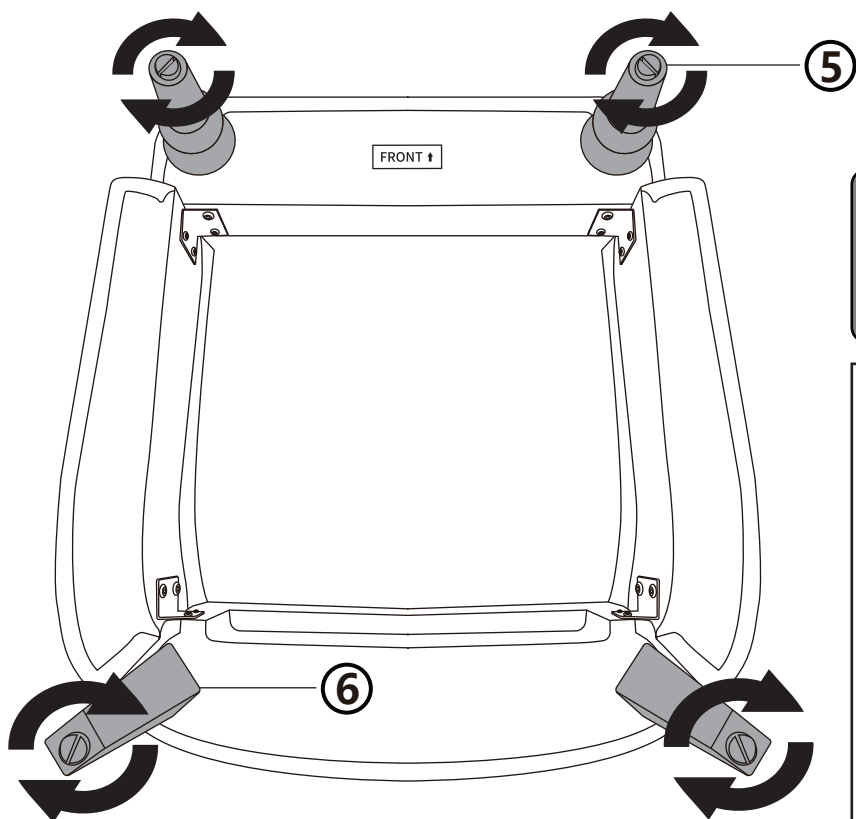
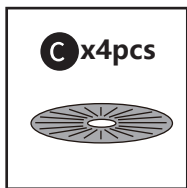

Note: Before installing the wooden foot, Remove the protective case install first, Then cover with non-slip plastic sheet

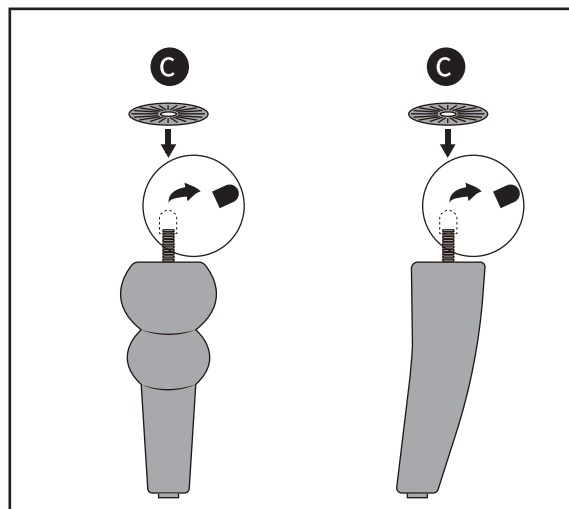

# Product Diagram

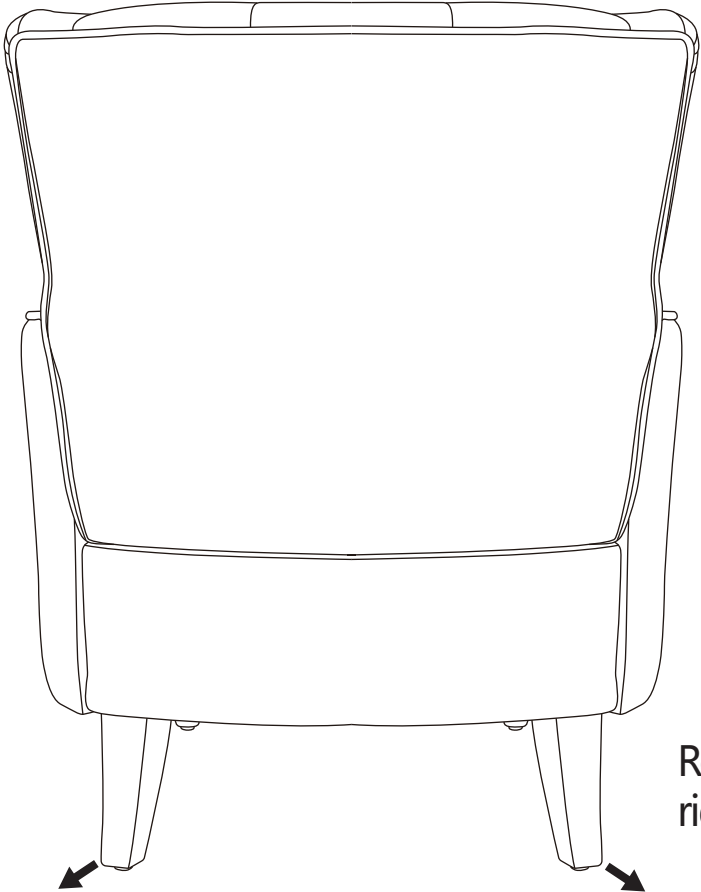
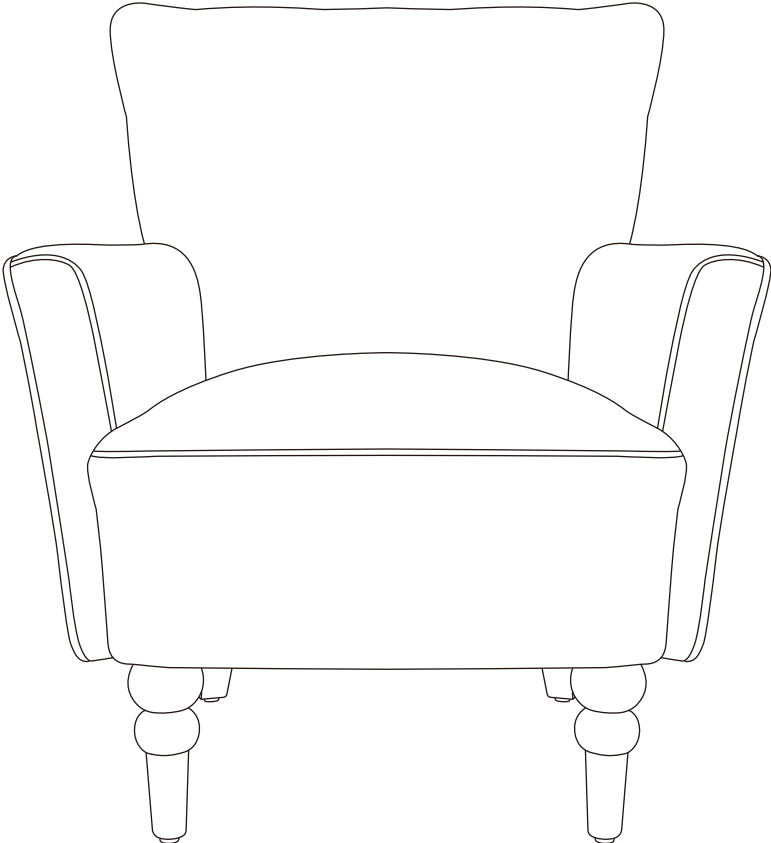

Rear leg must be facing right direction as shown.