

ASSEMBLY INSTRUCTION

Cabinet 4 Doors w/ Metal leg

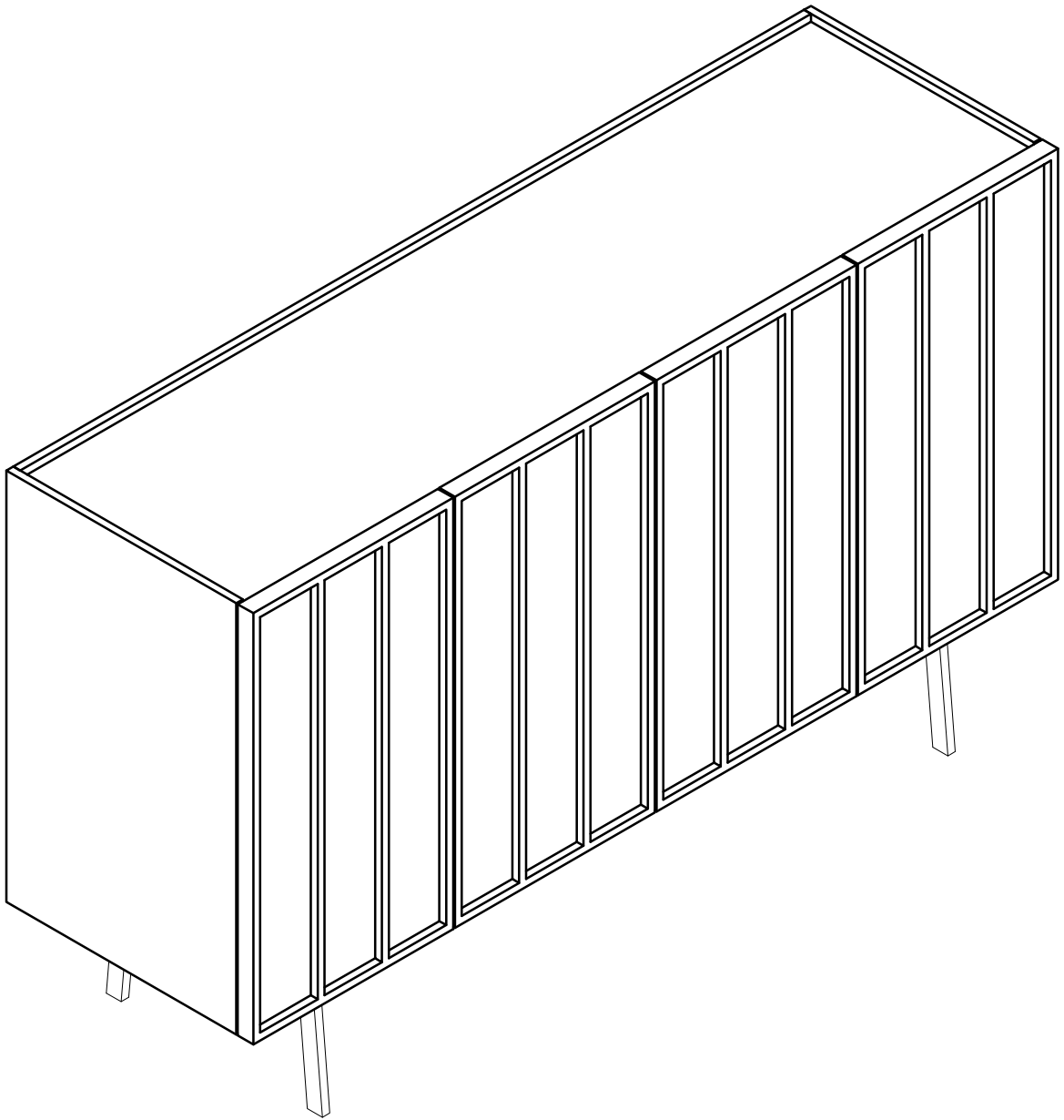

1. Thank you for choosing *our products*.

2. Return Policy







DO NOT RETURN TO THE STORE! Skip the process of returning your product and contact us directly for a replacement

If you find that parts of your order are missing or damaged, we will gladly ship any needed replacement parts free of charge.

If your product's quality does not meet your expectations or you have found any sort of defect, please contact our customer service department and let us know the details of your order and any issues encountered, we will try our best to provide you with a solution. Feel free to also directly contact our manufacturer at _____ concerning needed replacement parts and they will be happy to help provide you with a solution or answer any questions you may have.









Recommendations Before Beginning Assembly



-  • Read instructions, cover to cover
-  • Have 2-4 adults on hand for assembly depending on product size
-  • Do not assemble directly on flooring or carpet
-  • Assemble on a clean non-marring surface (example: packing foam)
-  • Save all packaging until finished

3. Assembly Notice:

- If you encounter any problems during assembly and find that you cannot continue, rest assured we will help you solve the situation as soon as possible. Simply keep all of the parts of the product stored in a safe place and contact us immediately so we may assist you further.
- Once you have opened your package, remove all inner hardware packages and take the parts out. One by one, Place the parts out neatly in front of you, then refer to the instructions to ensure no parts are missing. If any pieces are found missing, please carefully look in the box first, as the hardware packaging might have torn making the hardware spill in the box.
- Some key parts of your product may be stored and hidden inside of other parts. Please open any zippered or hook & loop storage compartments to remove all parts. (example: cushions and legs being stored in the underside of a sofa)
- **IMPORTANT:** When setting up your product, **DO NOT INSTALL THE SCREWS ALL THE WAY IN THE BEGINNING.** Place each screw into their proper hole and use your hand to twist the screw halfway. Twist all the screws in halfway to ensure the holes will match up properly and the product is level on the ground. When everything seems fitted, then tighten the screws.
- When you have completed assembly, we suggest you have more than one person to assist you with lifting and placing the product.

Care & Maintenance

-  Do not put hot items directly on furniture surface
-  Do not clean furniture with harsh cleansers or polish
-  Do not place furniture under direct sunlight
-  Do not place furniture near heating or cooling vents
-  Do not write on furniture without a padded barrier to protect the surface
-  Do not place furniture outside. For indoor use only
-  Not for commercial use. For residential use only
-  Stains may be removed with mild soap solution and damp cloth

  ● Children should not climb or jump on the furniture

  ● Dust and pick-up spills using a clean, non-colored, lint-free cloth

Caution

● This product contains small components. Please ensure that they are kept away from small children.

● Do not use power tools to assemble your furniture. Power tools may strip or damage the parts.

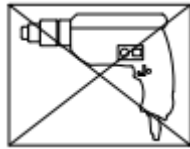

ASSEMBLY INSTRUCTION

Cabinet 4 Doors w/ Metal leg

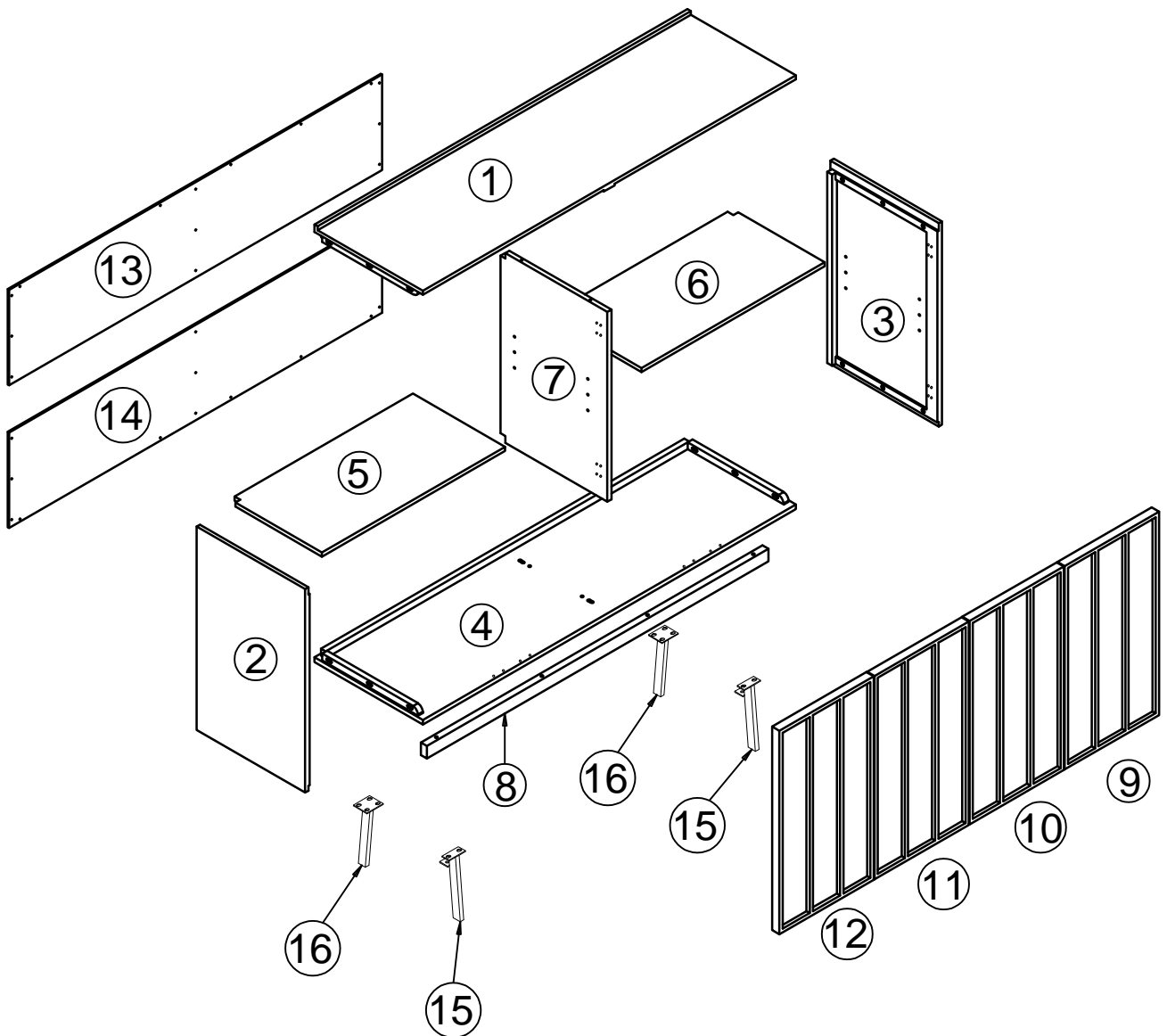

ASSEMBLY INSTRUCTION

Cabinet 4 Doors w/ Metal leg

Important – Please read these instructions fully before starting assembly

- Check you have all the components and tools listed on the following pages.
- Remove all fittings from the plastic bags and separate them into their groups.
- Keep children and animals away from the work area, small parts could choke if swallowed.
- Make sure you have enough space to layout the parts before starting.

- During assembly do not stand or put weight on the product, this could cause damage.
- Assemble the item as close to its final position (in the same room) as possible.
- Assemble on a soft level surface to avoid damaging the unit or your floor.
- Parts of the assembly will be easier with 2 people.



power drill is set on a low torque setting.

- To reduce the likelihood of damaging your product please ensure that your

Care and maintenance

- Only clean using a damp cloth and mild detergent, do not use bleach or abrasive cleaners.

- From time to time check that there are no loose screws on this unit.

- This product should not be discarded with household waste. Take to your local authority waste disposal centre.

Handy Hints

- Assemble all parts and bolts loosely during assembly, only once the product is complete should you fully tighten the bolts

- Regularly check and ensure That all bolts and fittings are tightend properly.

WARNING In order to help prevent overturning – please follow these instructions

To help prevent product toppling over please follow the below steps:-

Use the anti tip stap or wall fixing method provided (if applicable)

Do not allow children to climb or hang on the furniture

Do not open more than one drawer at a time

Do not place heavy items in the top drawers

Do not place heavy items on top of the furniture, unless the furniture has been designed for this purpose

Please note that only the anti tip strap is provided.

You will need to provide wall plugs and screws applicable for your wall type



Tools required







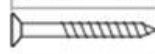

Phillips screwdriver
(medium & large)

Ruler - Use this ruler to help correctly identify the screws

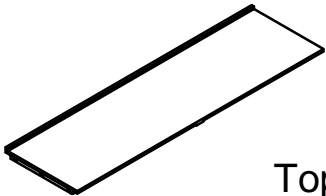
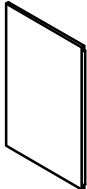
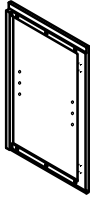
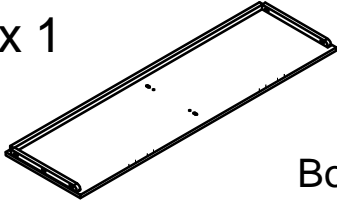
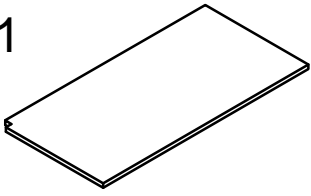
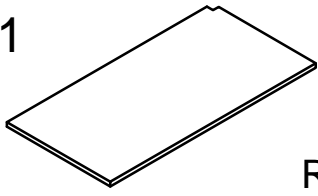
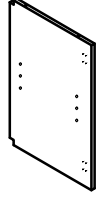
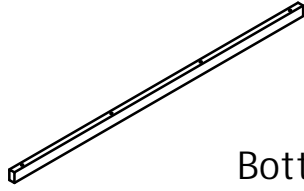



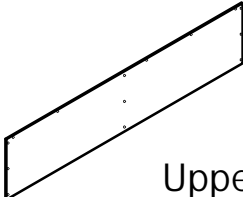
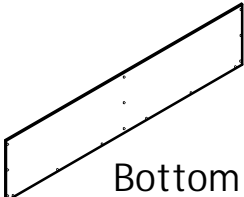





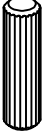
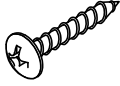

The screws length is measured from the head to the point (30mm screw shown).

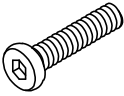
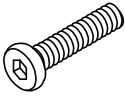
Part List

<p>① x 1</p>  <p>Top panel</p>	<p>② x 1</p>  <p>Left side</p>
<p>③ x 1</p>  <p>Right side</p>	<p>④ x 1</p>  <p>Bottom panel</p>
<p>⑤ x 1</p>  <p>Left shelf</p>	<p>⑥ x 1</p>  <p>Right shelf</p>
<p>⑦ x 1</p>  <p>Partition panel</p>	<p>⑧ x 1</p>  <p>Bottom rail</p>
<p>⑨ x 1</p>  <p>Left door</p>	<p>⑩ x 1</p>  <p>Middle door</p>
<p>⑪ x 1</p>  <p>Middle door</p>	<p>⑫ x 1</p>  <p>Right door</p>
<p>⑬ x 1</p>  <p>Upper back panel</p>	<p>⑭ x 1</p>  <p>Bottom back panel</p>
<p>⑮ x 2</p>  <p>Metal front leg</p>	<p>⑯ x 2</p>  <p>Metal back leg</p>

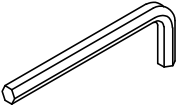
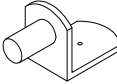
Hardware List

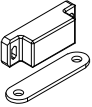
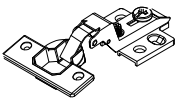
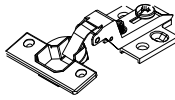
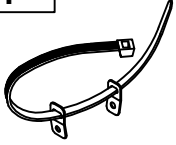



Box 1

<p>A</p>  <p>Ø8 x 30 mm Wood dowel 2pcs</p>	<p>B</p>  <p>M4x15mm Screw round head 30pcs</p>	<p>C</p>  <p>M6 x 30 mm Allen key bolt 14pcs</p>
<p>D</p>  <p>M6 x 40 mm Allen key bolt 4pcs</p>	<p>E</p>  <p>M6 x 15 mm Allen key bolt 14pcs</p>	<p>F</p>  <p>Cam lock pin cam lock 2 Sets</p>
<p>G</p>  <p>M4x15mm Wood Screw 48pcs</p>	<p>H</p>  <p>M3x10mm Wood Screw 16pcs</p>	<p>I</p>  <p>M3x15mm Wood Screw 16pcs</p>
<p>J</p>  <p>Allen key 1pcs</p>	<p>K</p>  <p>Shelf Support 8pcs</p>	<p>L</p>  <p>M3.5x10mm Wood Screw 8pcs</p>
<p>M</p>  <p>Magnet And Plate 16pcs</p>	<p>N</p>  <p>Adjustable Hinge 4pcs</p>	<p>O</p>  <p>Adjustable Hinge open 180 4pcs</p>
<p>P</p>  <p>a. M4 X 15mm - QTY 1 b. M4 X 40mm - QTY 1</p> <p>FURNITURE TIP OVER RESTRAINT QTY 1 SET</p>	<p>Q</p>  <p>Ø16/Ø6-1mm Washer 14pcs</p>	

ASSEMBLY TOOLS REQUIRED (NOT INCLUDED)

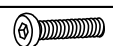

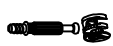

STEP: 1

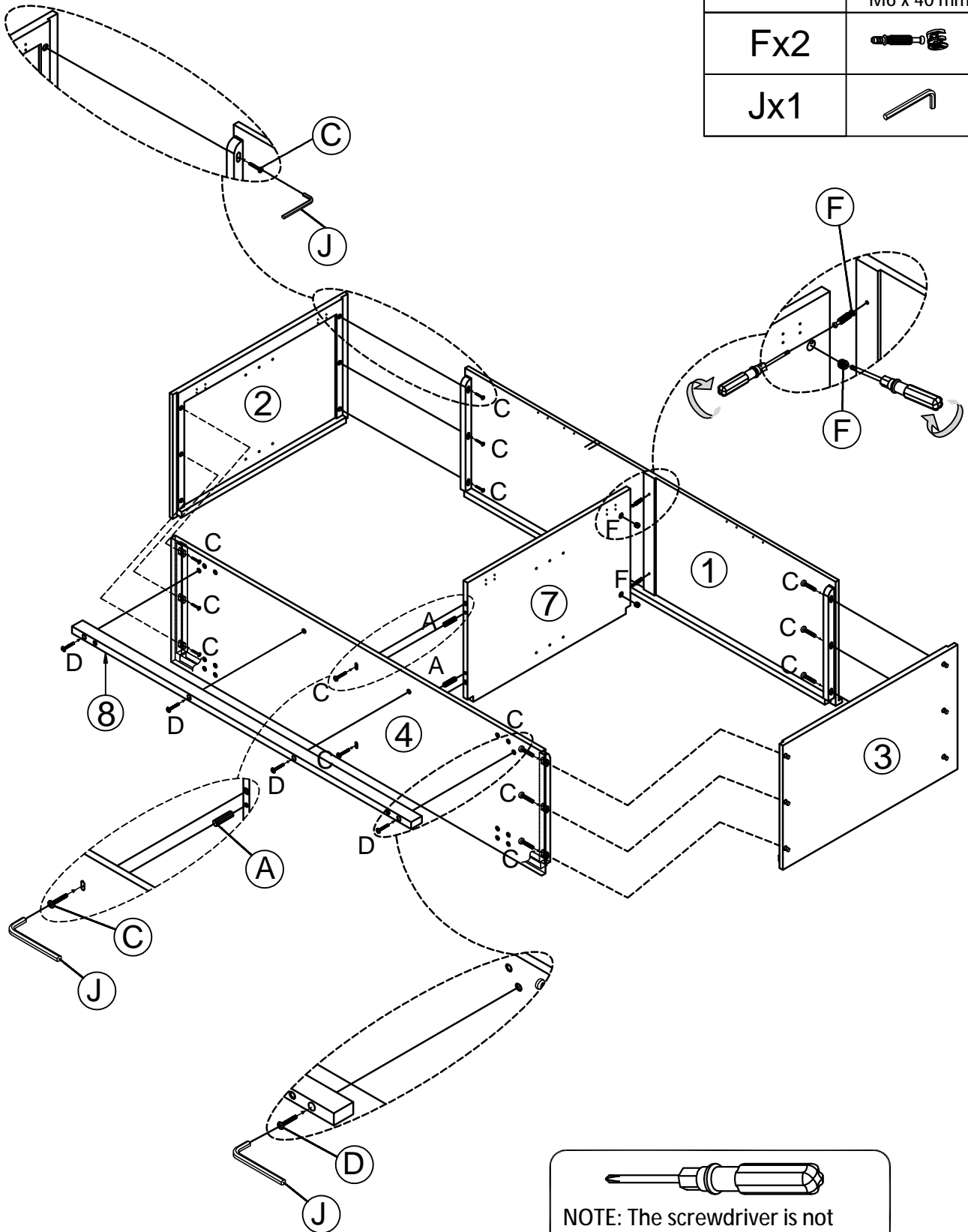
Ax2	 Ø8 x 30 mm
Cx14	 M6 x 30 mm
Dx4	 M6 x 40 mm
Fx2	
Jx1	



NOTE: The screwdriver is not included in the hardware pack.

STEP: 2

Ex14	 M6 x 15 mm
Qx14	 Ø16/Ø6-1mm
Jx1	

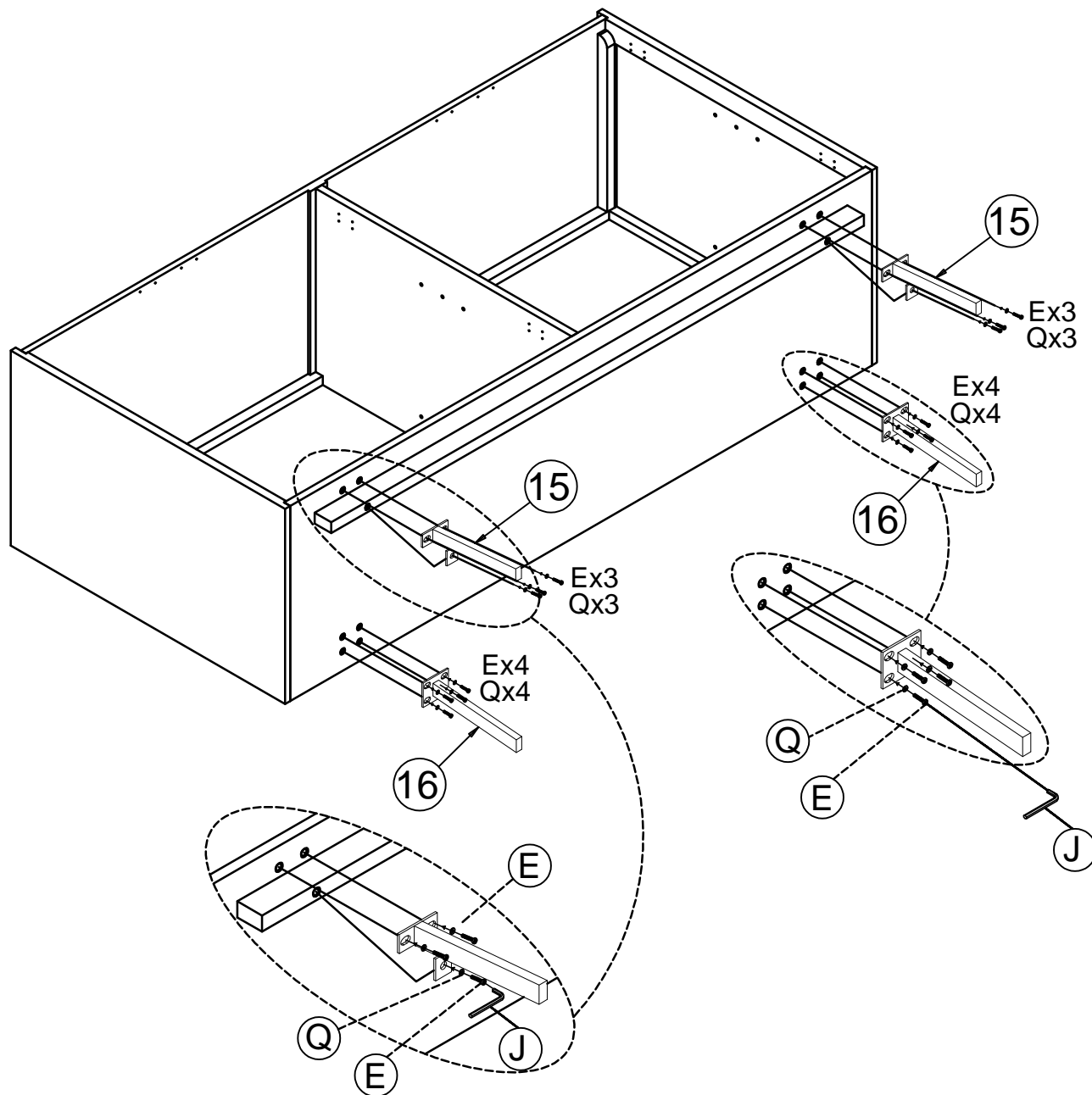

STEP: 3

Kx8

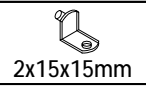

2x15x15mm

Lx8



M3.5x10mm

shelf level 1

shelf level 2

shelf level 3

K

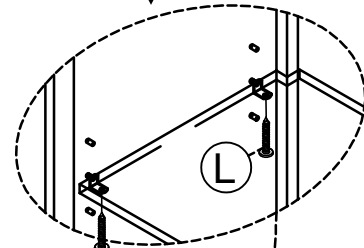
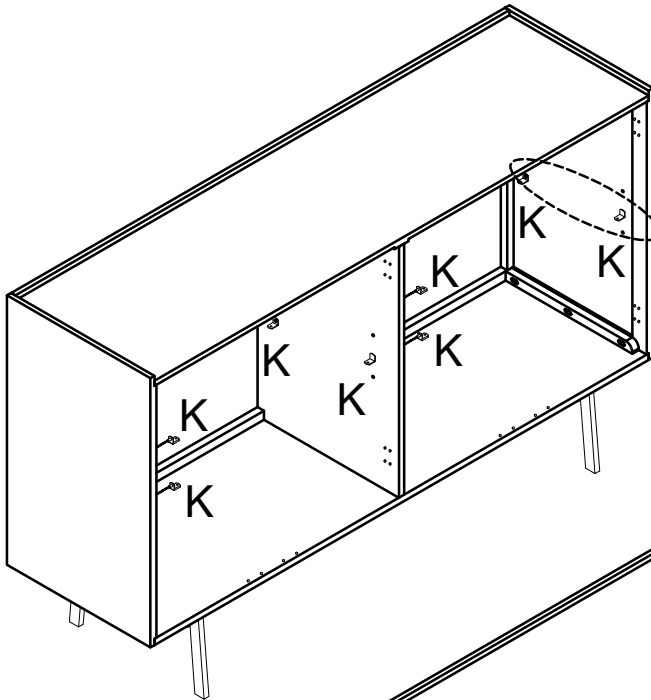

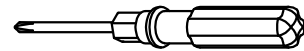
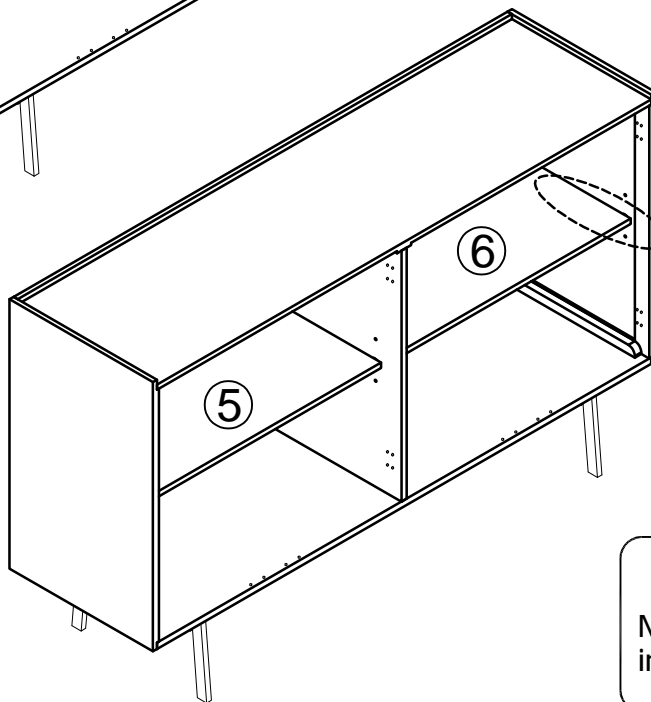

L



NOTE: The screwdriver is not included in the hardware pack.

STEP: 4

Gx16	 M4x15mm
Nx4	
Ox4	

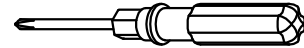
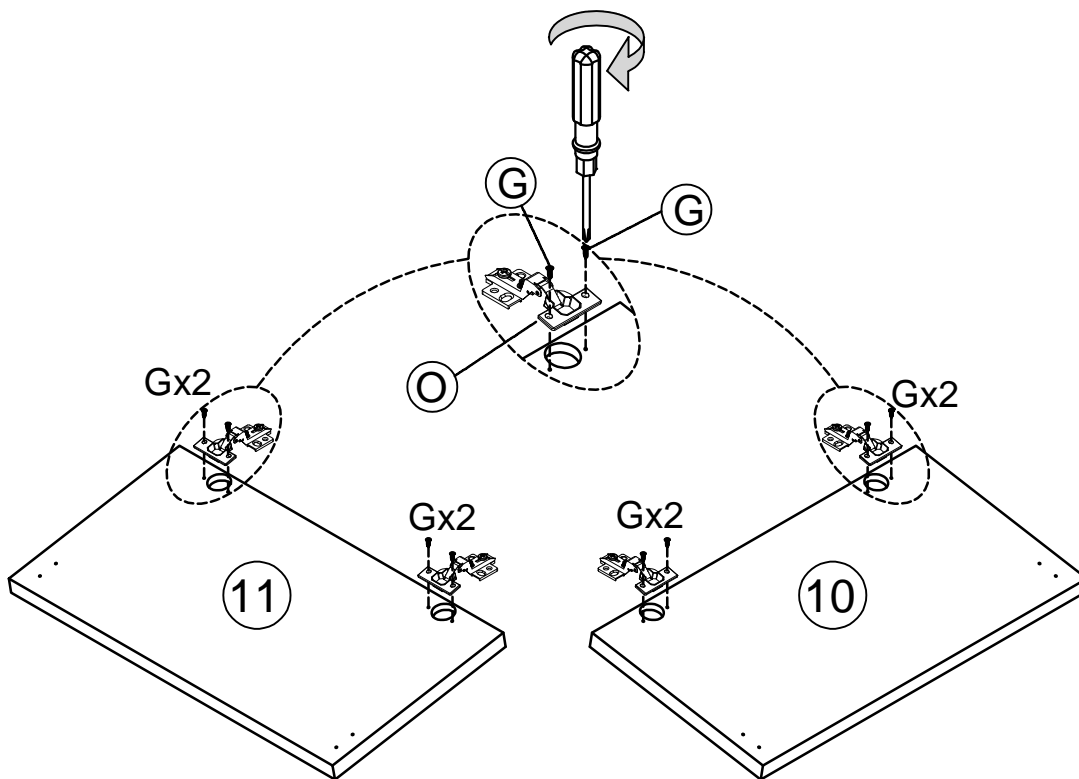
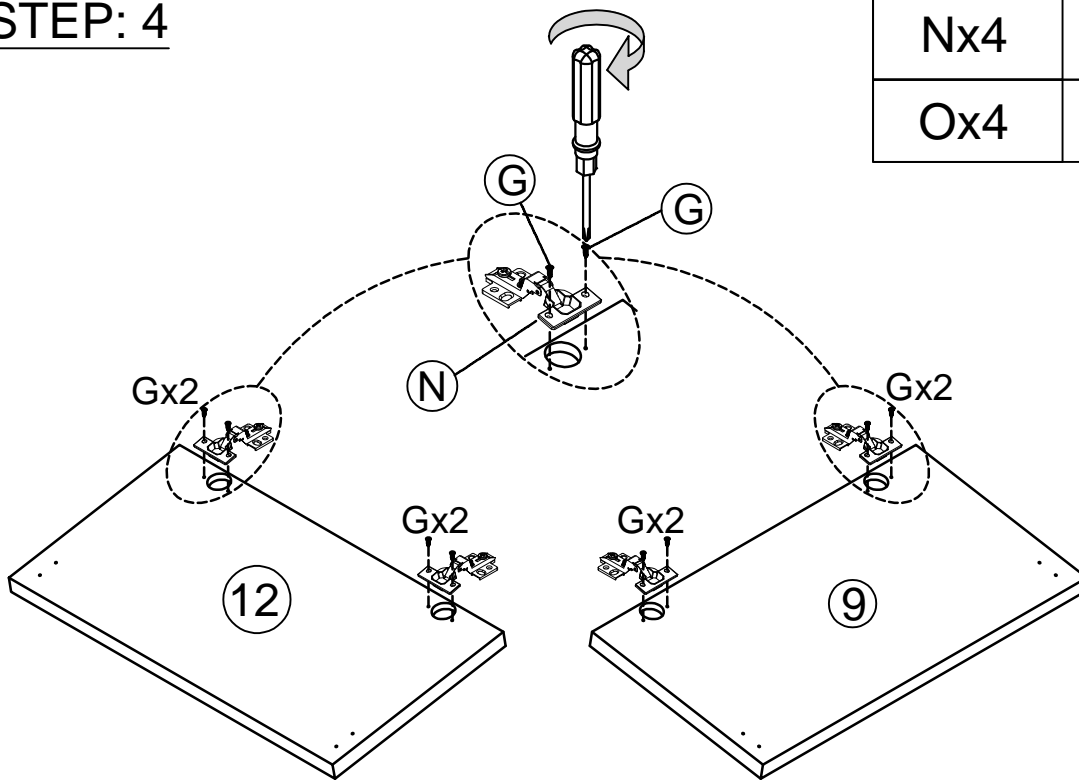



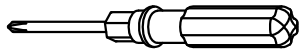

NOTE: The screwdriver is not included in the hardware pack.

STEP: 5



NOTE: The screwdriver is not included in the hardware pack.

Gx32	 M4x15mm
Hx16	 M3x10mm
Ix16	 M3x15mm
Mx16	

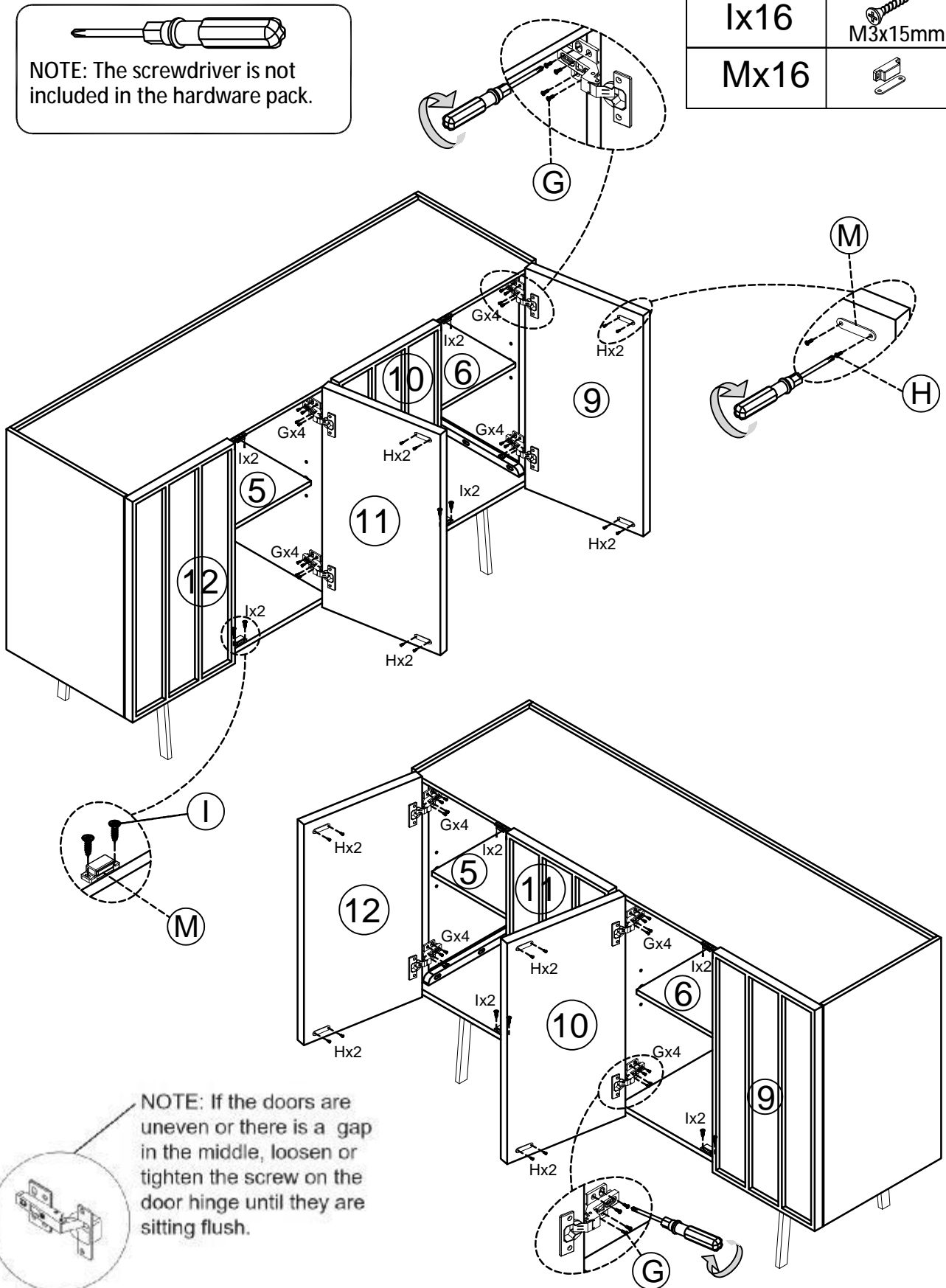

Bx30

M4x15mm

STEP: 6

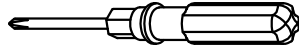

NOTE: The screwdriver is not included in the hardware pack.

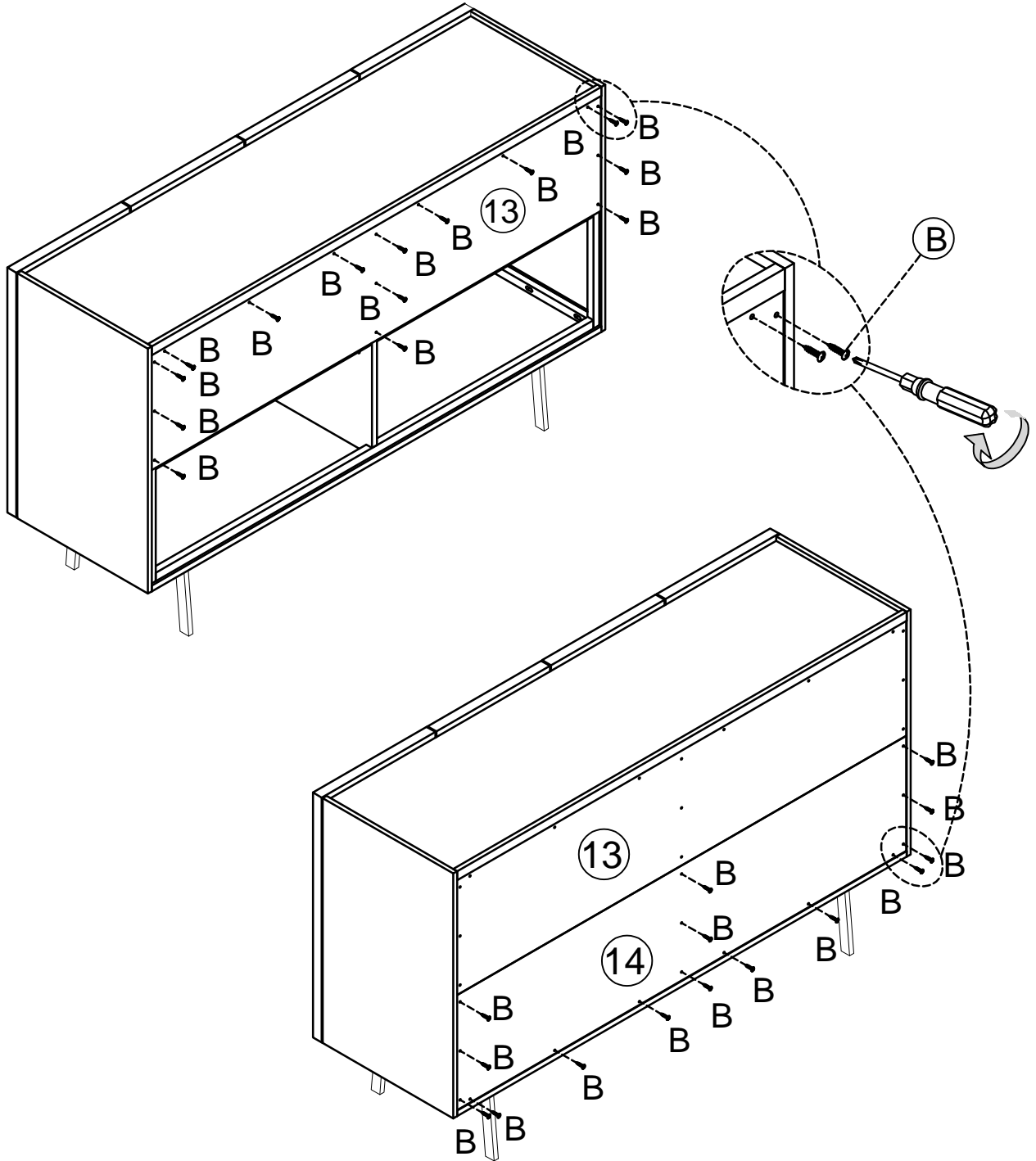



WARNING

Serious or fatal crushing injuries can occur from furniture tip-over.
If the furniture tip over restraint kit is not in the box, please contact our customer service department in order to obtain another kit before using the furniture.

P		a) MAX 15mm - QTY 1 b) MAX 40mm - QTY 1	1
---	---	--	---

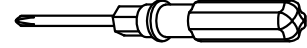

NOTE: The screwdriver is not included in the hardware pack.

STEP: 7

