

Worktable Instruction

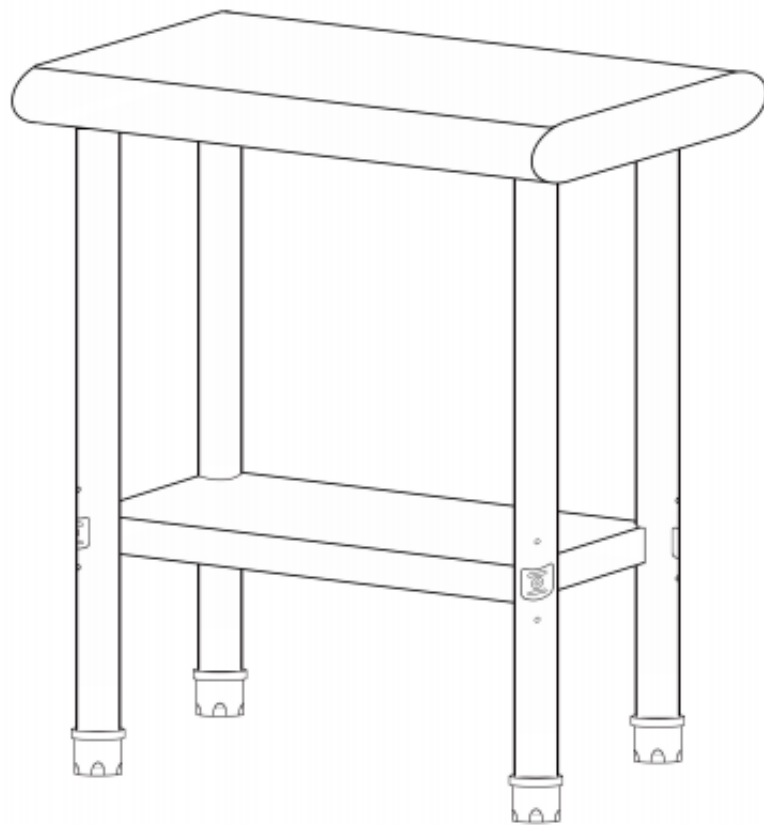

Item NO.	Reference Image	Qty.
A		1
B		4
C		4
D		2
E		4
F		4
G	 M8×65mm	4

Item NO.	Reference Image	Qty.
H	 M8	13 12 + 1 Spare parts
I		17 16 + 1 Spare parts
J	 M8	4
K		1

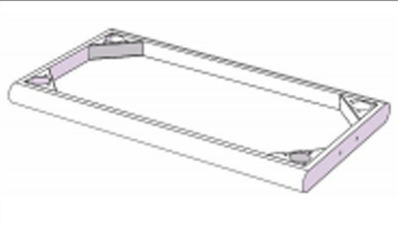
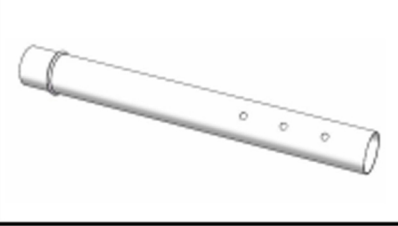
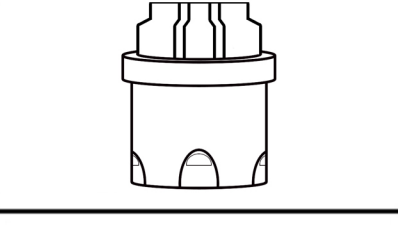
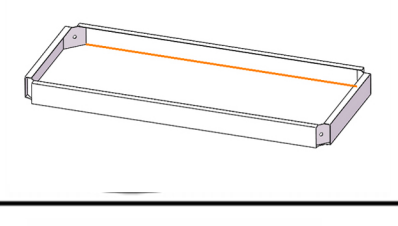
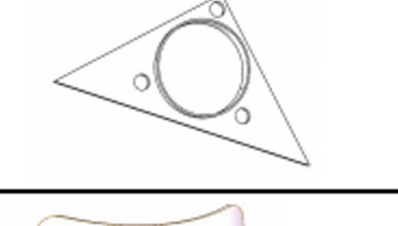
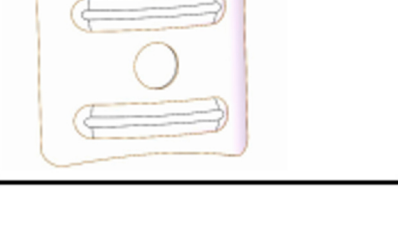
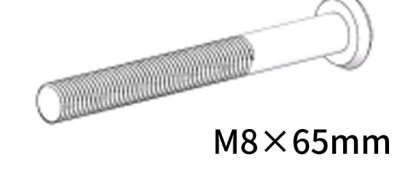
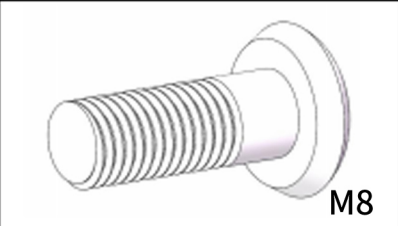
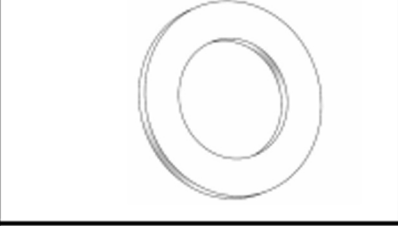
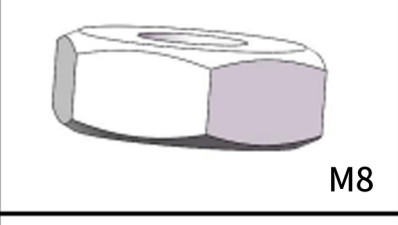
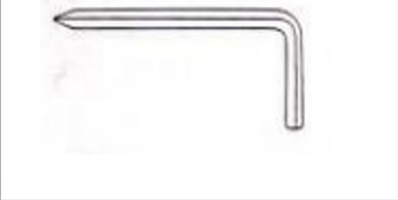