

2-Door 1-Drawer TV Stand

SKU WHIF2219

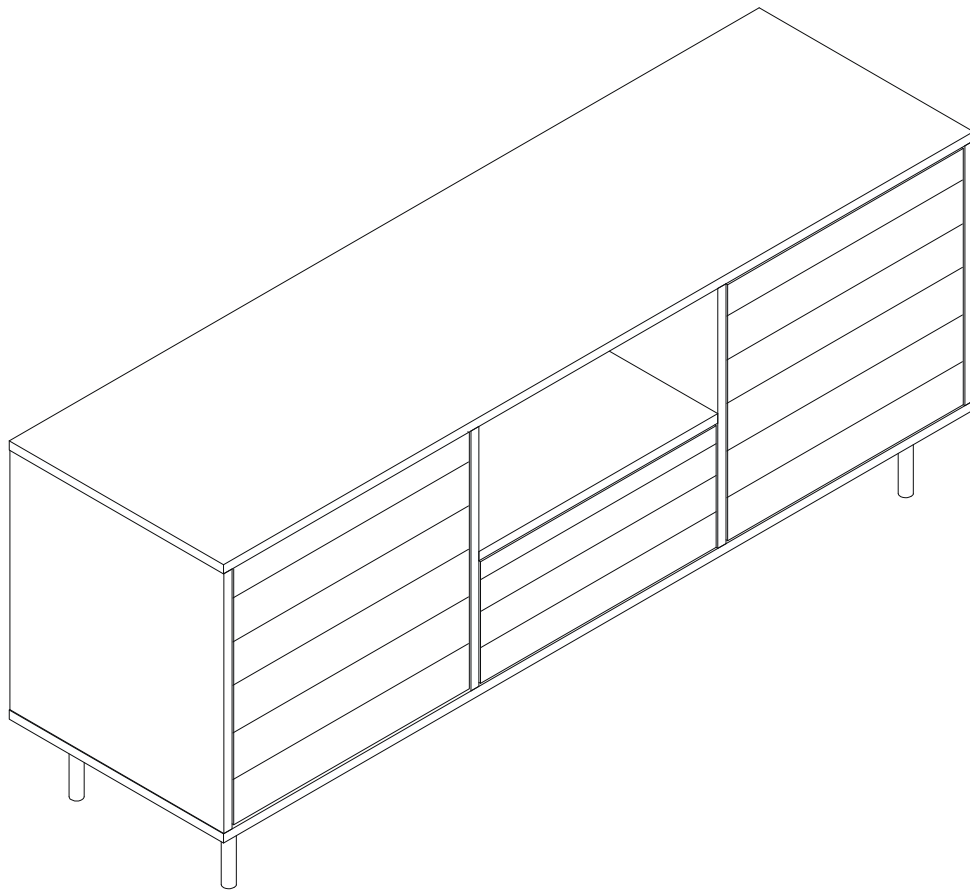

ASSEMBLY INSTRUCTIONS



60 min. assembly

2 person

*The estimated assembly time may vary depending on the individual.

Hey, there

Now is assembly time!

Deeeeeeep breathe.... and again....
Tools ready,
Easy peasy!

Estimated



60 min. assembly
2 person

Tools Required

- Allen Wrench (included)
- Phillips screwdriver (not included)
- Power Drill (not included)

***important:** Cautious when you use power tools*

Need Help?

Call us at +1 909 548 6688
Email customerservice@luxenhome.com
Submit a ticket on www.luxenhome.com/help

Thank you for purchasing this LuxenHome product. This product has been manufactured with the highest standards of safety and quality.

PLEASE READ ALL INSTRUCTIONS CAREFULLY BEFORE ASSEMBLY.

Un pack all parts from the packaging inside the carton to ensure there are no missing or damaged parts. Lay out all the parts on a clean, flat, and soft surface to prevent scratches. Refer to the steps provided as assembling guide.

Do not attempt to assemble or use the product if any parts are missing or damaged.

REMINDERS

SAFE USAGE IS KEY

Your well-being is our top priority when you use our product. Please prioritize your safety by diligently following the assembly guidelines and inspecting the product carefully both when it arrives and before each use.

Please be aware that LuxenHome and Winsome House, Inc. cannot be held liable for any injuries or fatalities that occur due to not adhering to the provided instructions or misuse of the product.

DO NOT MODIFY

Our products undergo rigorous testing to ensure they meet established safety standards before being released for sale. Altering the product in any way can lead to serious safety concerns, for which LuxenHome cannot assume responsibility.

What's in the box

Parts

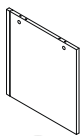

1 X 1

Middle support panel

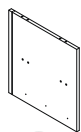

2 X 1

Middle support panel

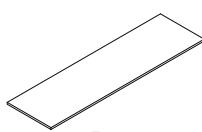

3 X 1

Top panel

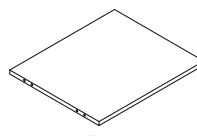

4 X 1

Shelf panel

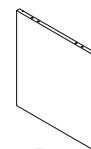

5 X 1

Left side panel

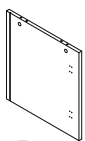

6 X 1

Right side panel

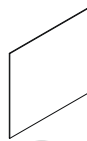

7 X 2

Back panel

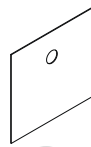

8 X 1

Middle back panel

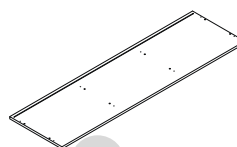

9 X 1

Bottom panel

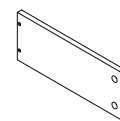

10 X 1

Left drawer side panel

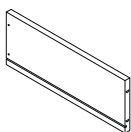

11 X 1

Right Drawer side panel

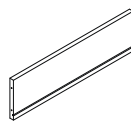

12 X 1

Drawer back panel

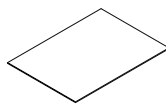

13 X 1

Drawer bottom panel

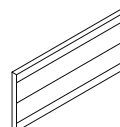

14 X 1

Drawer front panel

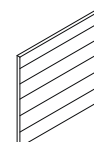

15 X 2

Door panel



16 X 4

Metal leg















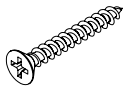
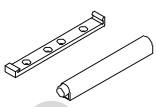

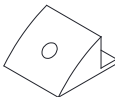
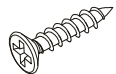
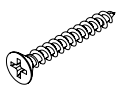
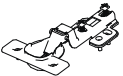
17 X 2

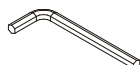
Middle adjustable leg

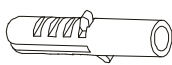
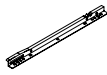
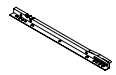
What's in the box

Hardware & Accessory

				
A X 16+2 M6 x 36mm	B X 16+2 M15 x 9mm	C X 20+3 M5.8 x 30mm	D X 9 M3 x 12mm	E X 12+2 M3.5 x 12mm
				
F X 10+2 M4 x 35mm	G X 3	H X 24+3 M6 x 12mm	I X 12+2 Wedges	J X 12+2 M3 x 16mm
				
K X 4 M4 x 30mm	L X 4 Hinge	M X 24+3 M4 x 14mm	N X 1 Allen key	O X 2 Wall strap&wahser
				
P X 2 M4 x 14mm	Q X 2 Wall plug	DL X 1 Inner left drawer runner	DR X 1 Inner right drawer runner	CL X 1 Outer left drawer runner
				
CR X 1 Outer right drawer runner	G-1 X 3			

Assembly

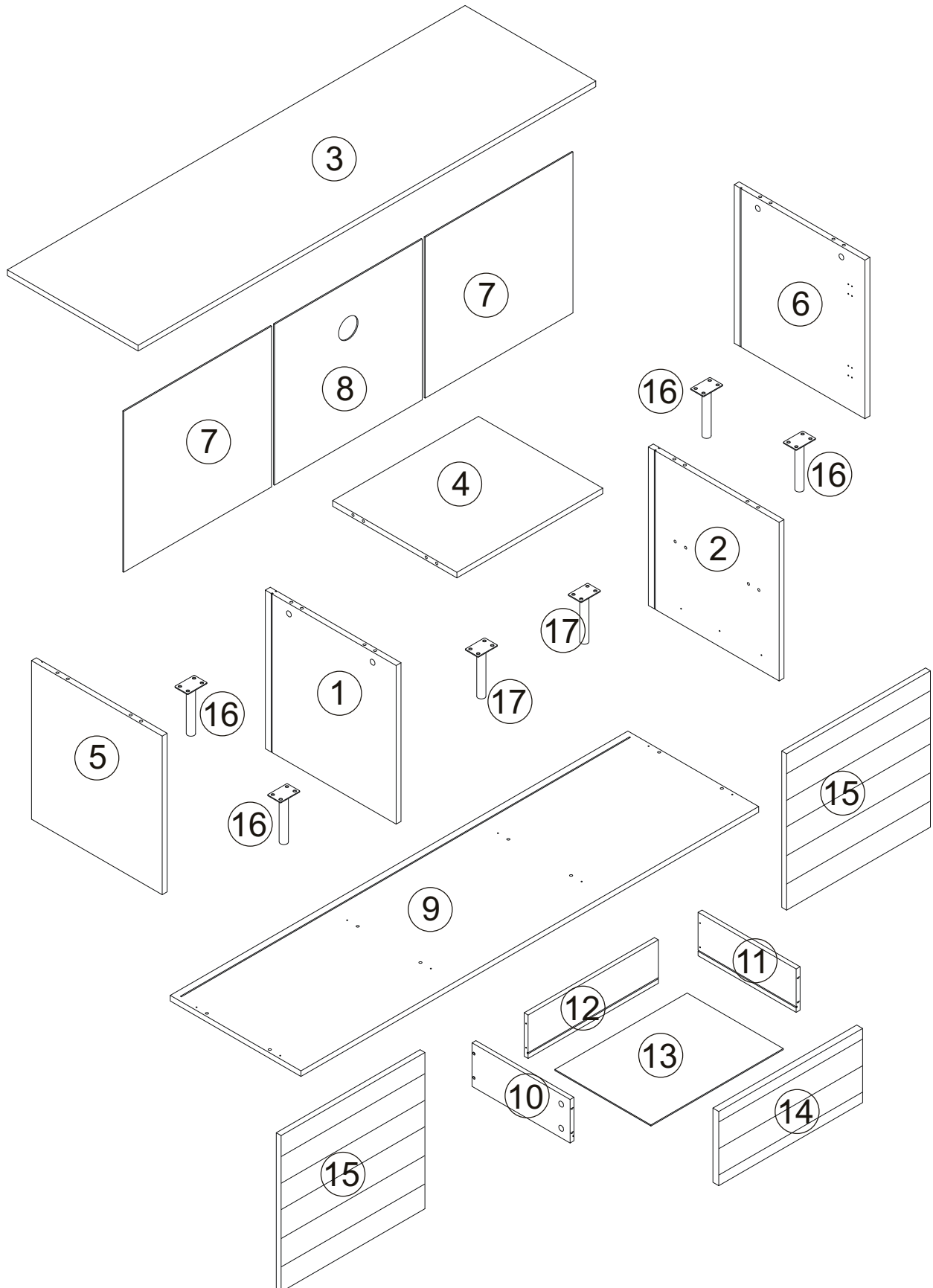

Step 1

Insert quickfit screws (A) into parts 1 and 2, as shown.

Fix left outer drawer runner (CL) and right outer drawer runner (CR) to parts 1 and 2 using screws (E), as shown.

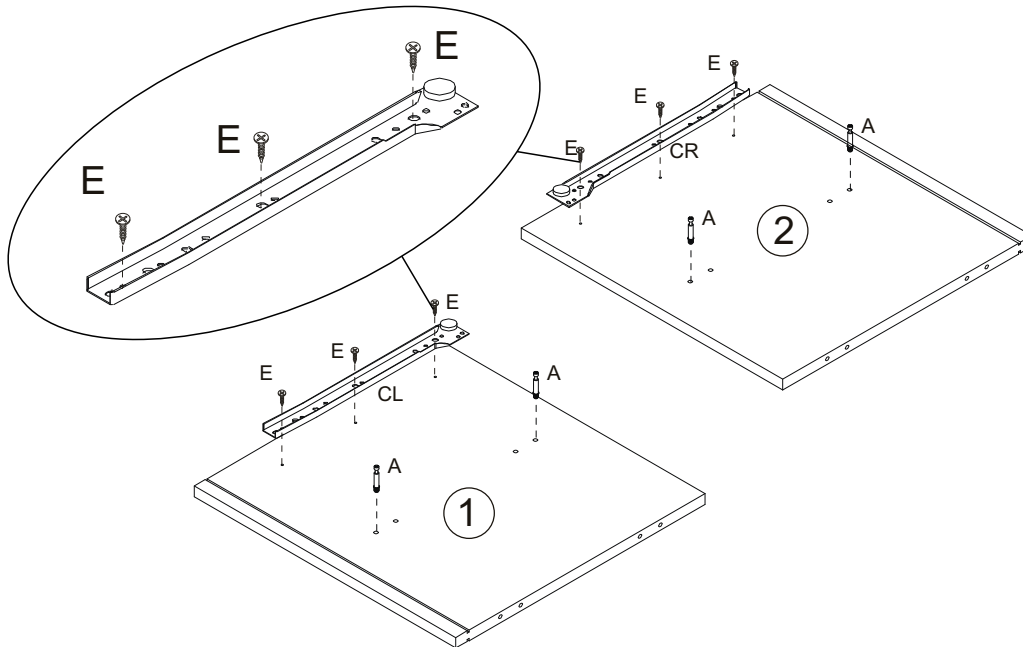

CLx1
CRx1
E x6
M3.5 x 12mm
Ax4
M6 x 36mm

Step 2

Insert quickfit screws (A) into part 3, as shown.

Fix door openers (G) to parts 3 and 4 using screws (D), as shown.

Insert catches into opener (G), as shown.

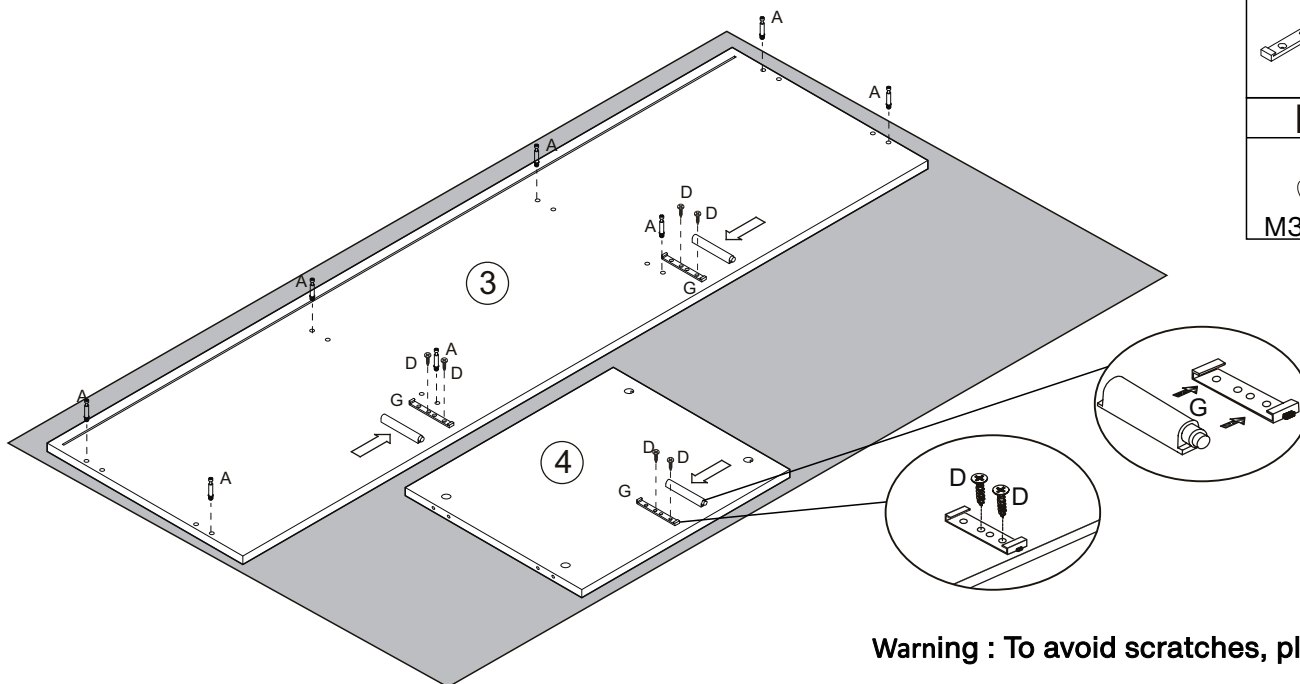



Ax8
M6 x 36mm
Gx3
Dx6
M3 x 12mm

Warning : To avoid scratches, place the panels on a clean and soft surface.

Step 3

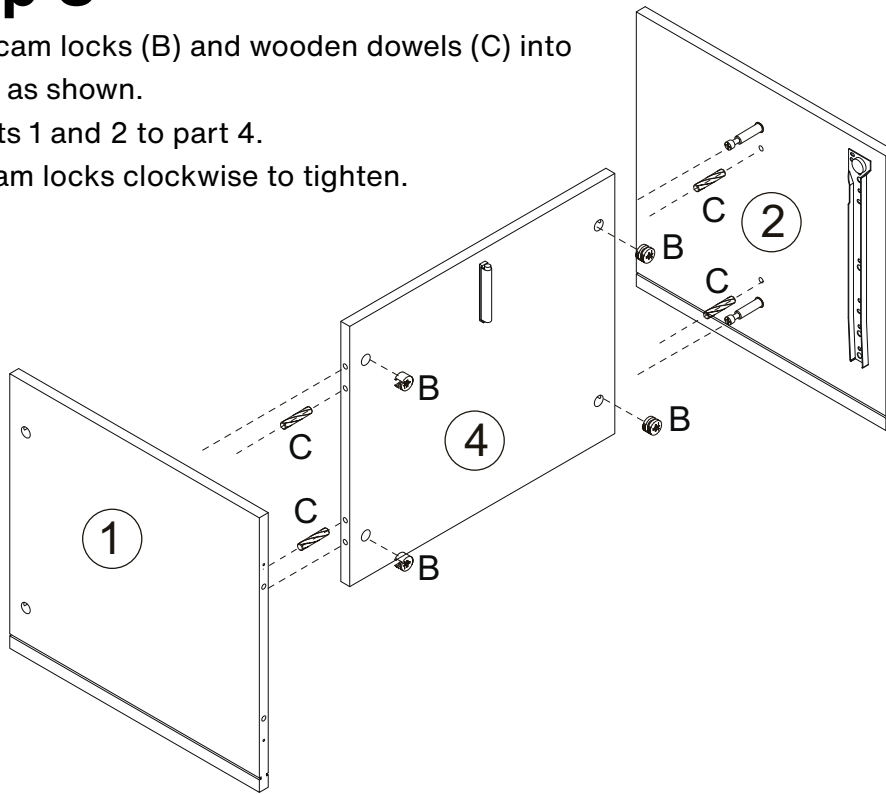
Insert cam locks (B) and wooden dowels (C) into part 4, as shown.
Fit parts 1 and 2 to part 4.
Turn cam locks clockwise to tighten.





Bx4
 M15 x 9mm
Cx4
 M5.8 x 30mm

Step 4

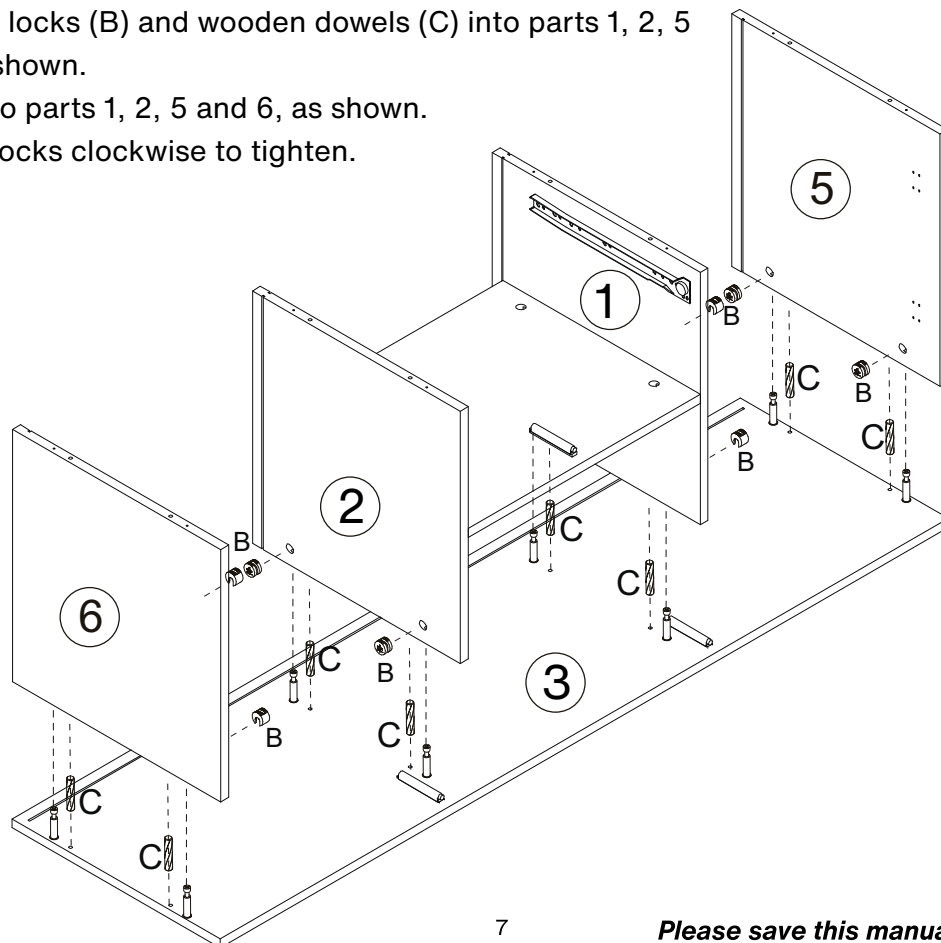
Insert cam locks (B) and wooden dowels (C) into parts 1, 2, 5 and 6, as shown.
Fit part 3 to parts 1, 2, 5 and 6, as shown.
Turn cam locks clockwise to tighten.



Bx8
 M15 x 9mm
Cx8
 M5.8 x 30mm

Step 5

Insert parts 7 and 8 into grooves between parts 1, 2, 5, 6 and 3, as shown.

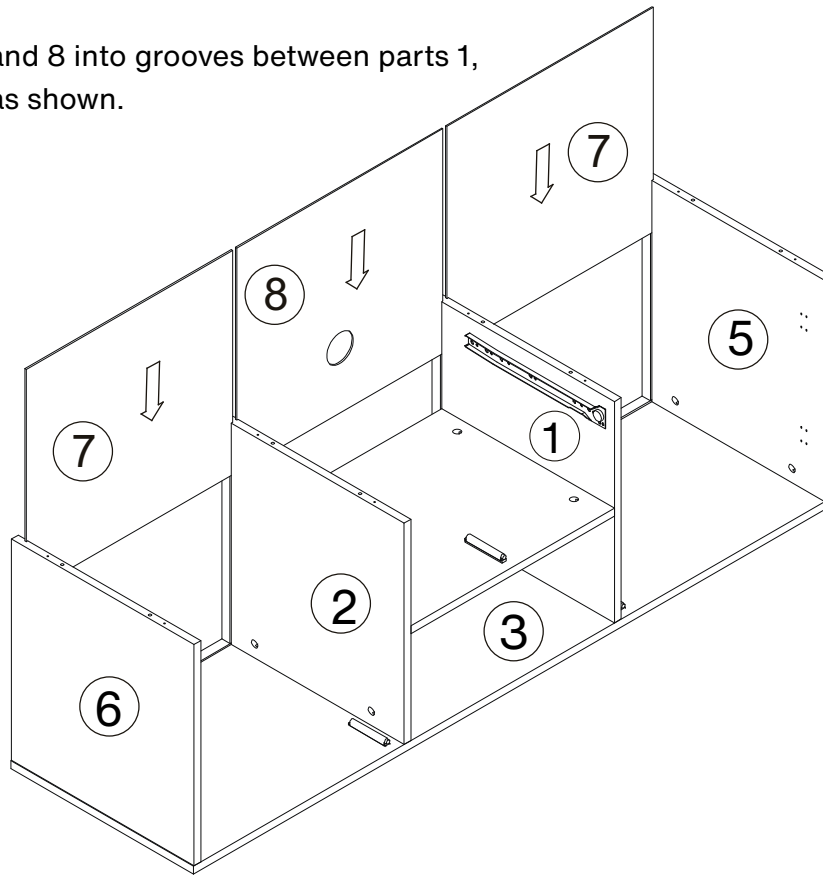

Step 6

Insert wooden dowels (C) into parts 1, 2, 5 and 6, as shown.

Fix part 9 to parts 1, 2, 5 and 6 using screws (F), as shown.

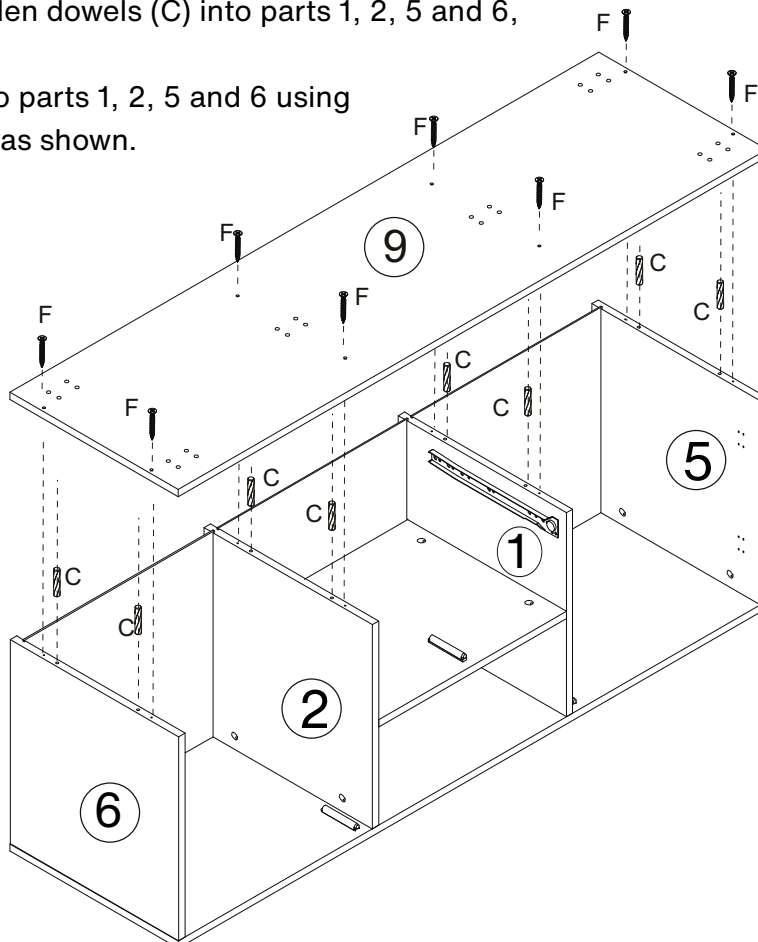

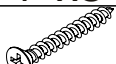
Cx8
 M5.8 x 30mm
F x8
 M4 x 35mm

Step 7

Fix legs 16 and 17 to part 9 using screws (H) and allen key (N), as shown.

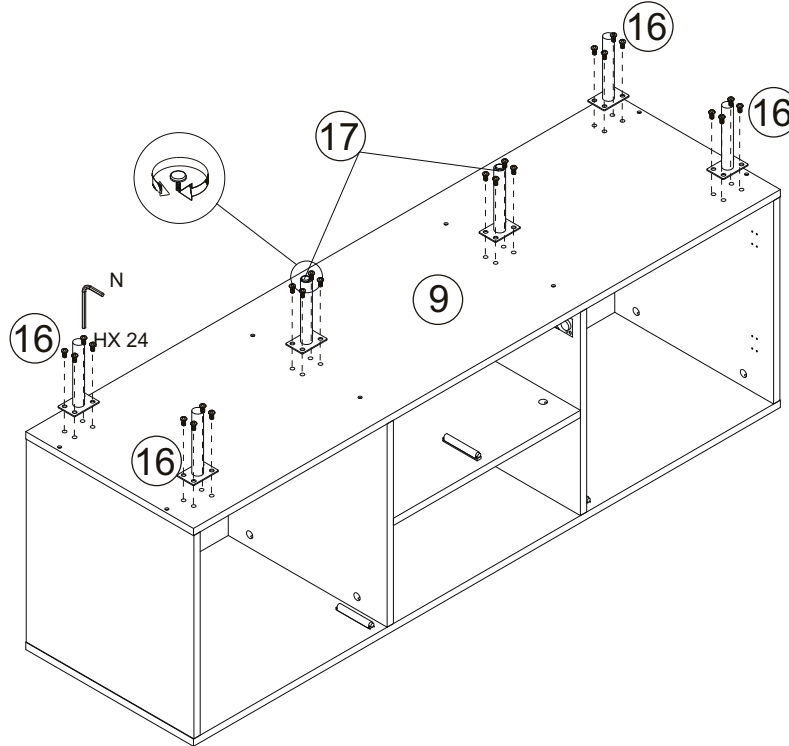

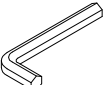
Hx24

M6 x 12mm
Nx1

Step 8



Fix wall straps (O-1) to part 3 using washers (O-2) and screws (P), as shown. Secure backing panels 7 and 8 by fixing wedges (I) using screws (J), as shown.

ATTENTION PLEASE

Please ensure the structure is straight and level and all panels are at right angles before installing hardware (I).

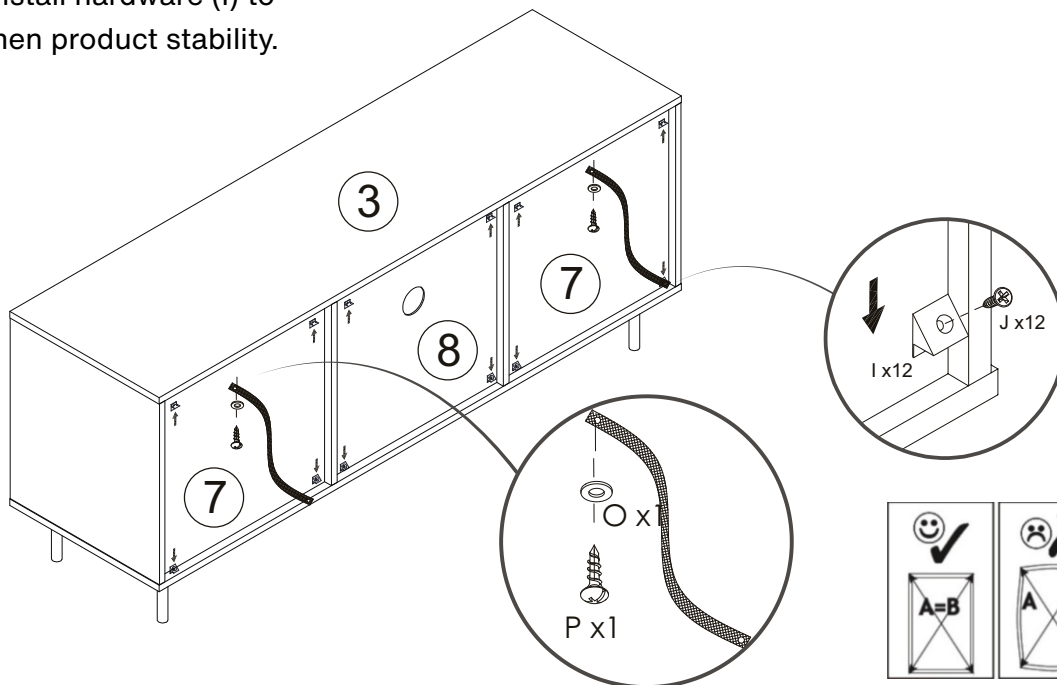
MUST install hardware (I) to strengthen product stability.

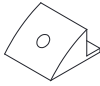

Jx12

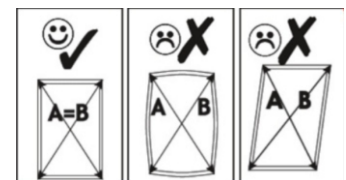
M3 x 16mm
Ix12

Ox2

Px2

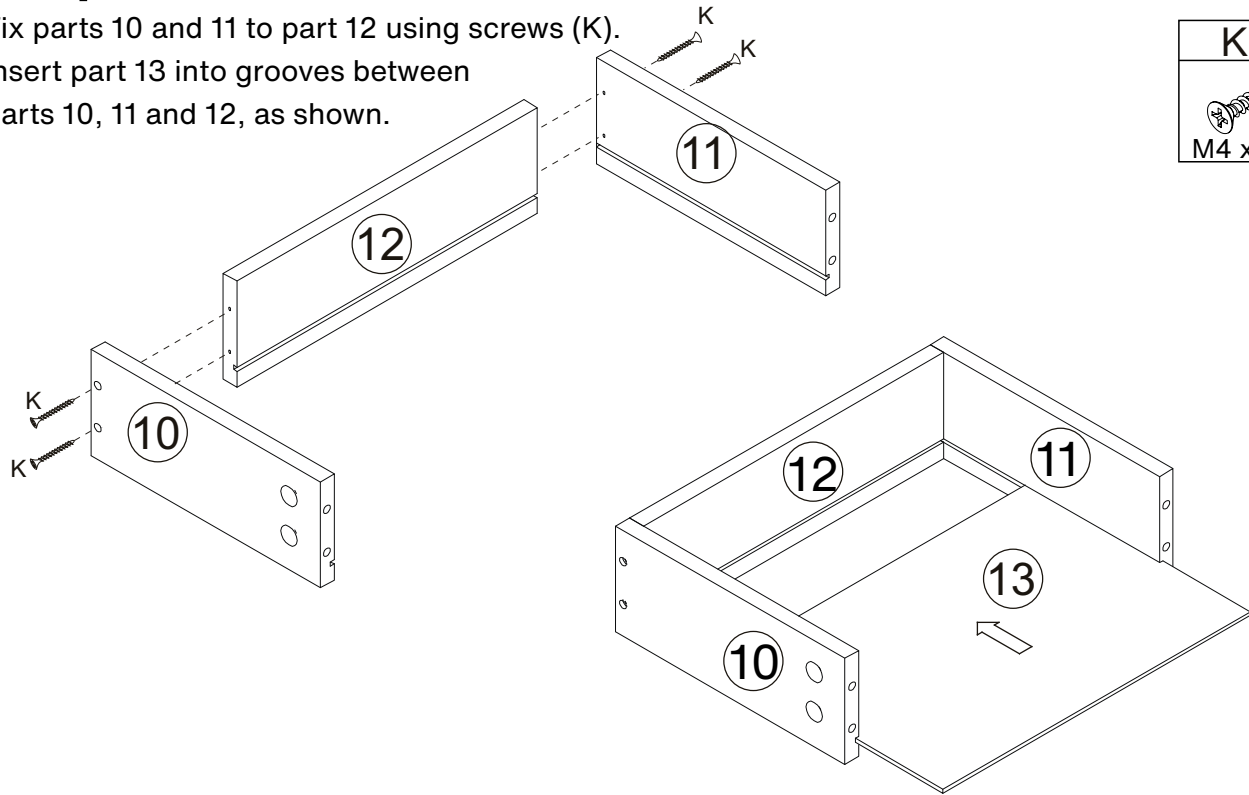
M4 x 14mm

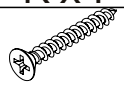

Step 9

Fix parts 10 and 11 to part 12 using screws (K).
 Insert part 13 into grooves between parts 10, 11 and 12, as shown.





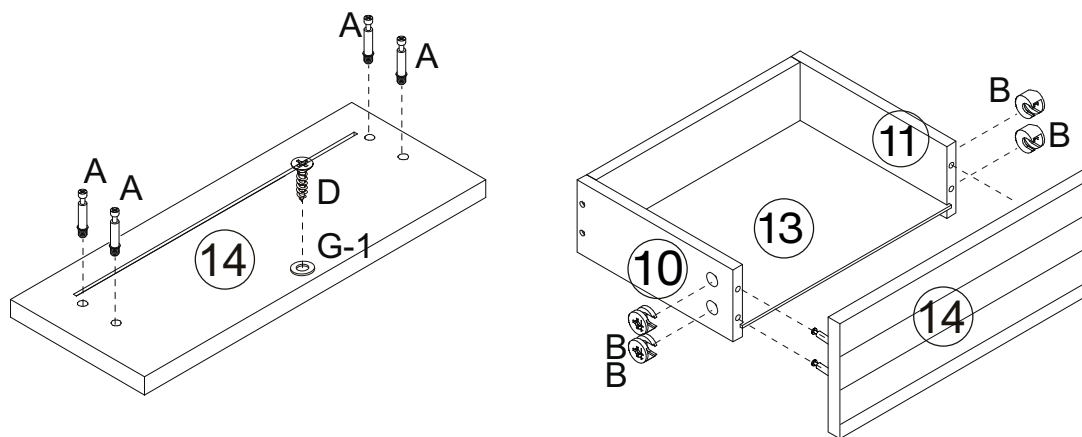

K x4

M4 x 30mm

Step 10

Insert quickfit screws (A) into part 14, as shown.
 Insert cam locks (B) into parts 10 and 11, as shown.
 Fix washer (G-1) to part 14 using screw (D), as shown.
 Fit part 14 to parts 10, 11 and 13.
 Turn cam locks clockwise to tighten.



A x4

M6 x 36mm
B x4

M15 x 9mm
D x1

M3 x 12mm
G-1 x1

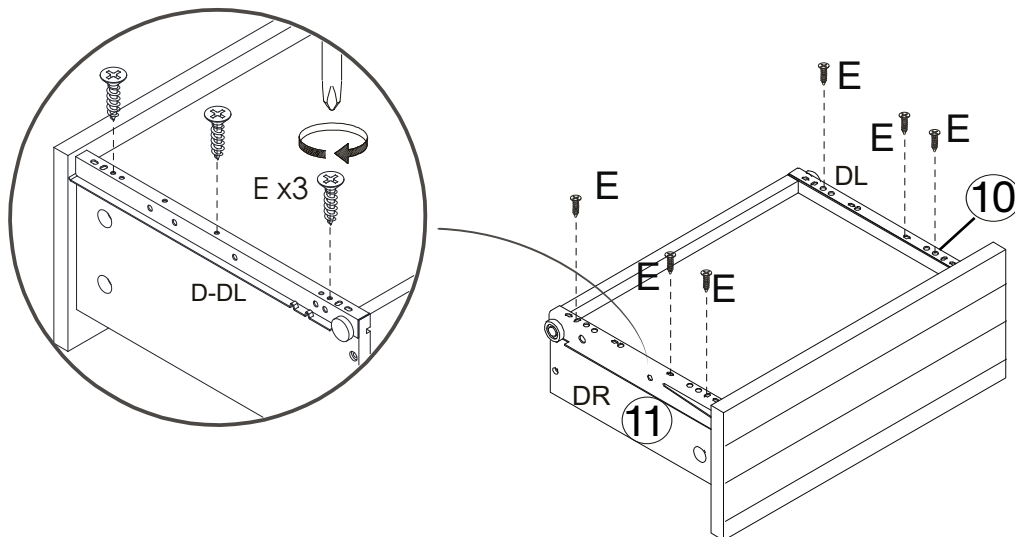
Step 11

Fix right inner drawer runner (DR) and left inner drawer runner (DL) to parts 10 and 11 using screws (E), as shown.

DRx1
DLx1
Ex6
M3.5 x 12mm



Step 12

Insert drawer into the assembled unit, as shown.

For extra stability, it is recommended that you fix your TV Stand to the wall using hardware (F, O and Q), as shown.

Screws (F) are fixed through washers (O) and wall straps and into the wall plugs (Q).

Should you choose not to affix the product to the wall, serious injury may be caused if the product tips over.



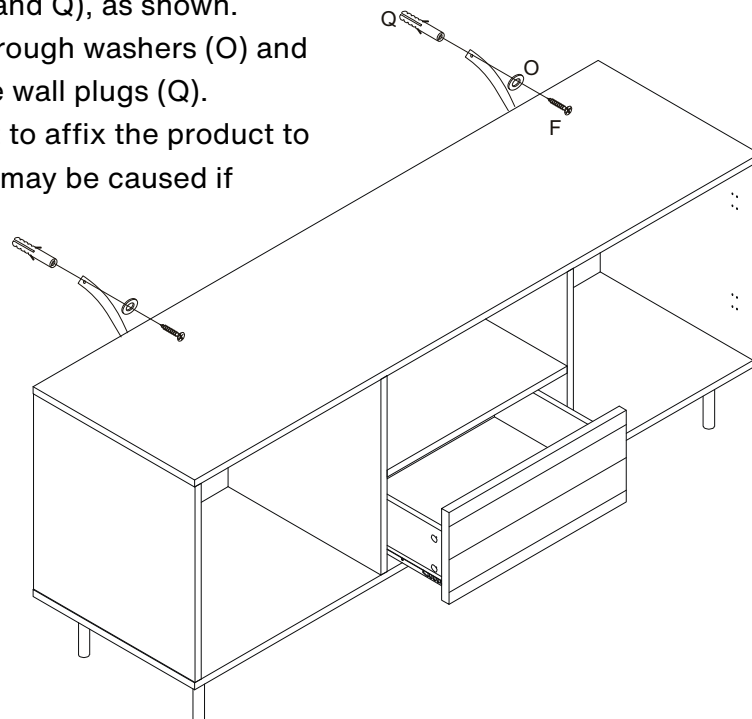

Fx2
M4 x 35mm
Ox2
Qx2

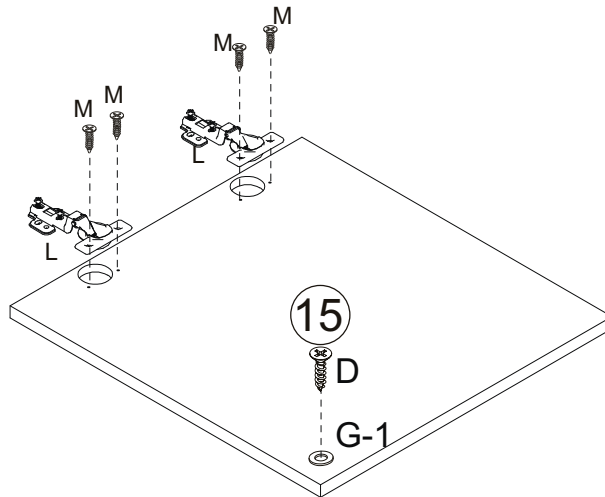

Step 13

Fix hinges (L) to doors 15 using screws (M), as shown.
 Fix washers (G-1) to doors 15 using screws (D), as shown.





Mx8
 M4 x 14mm
Lx 4

Dx 2
 M3 x 12mm
G-1x2

X 2

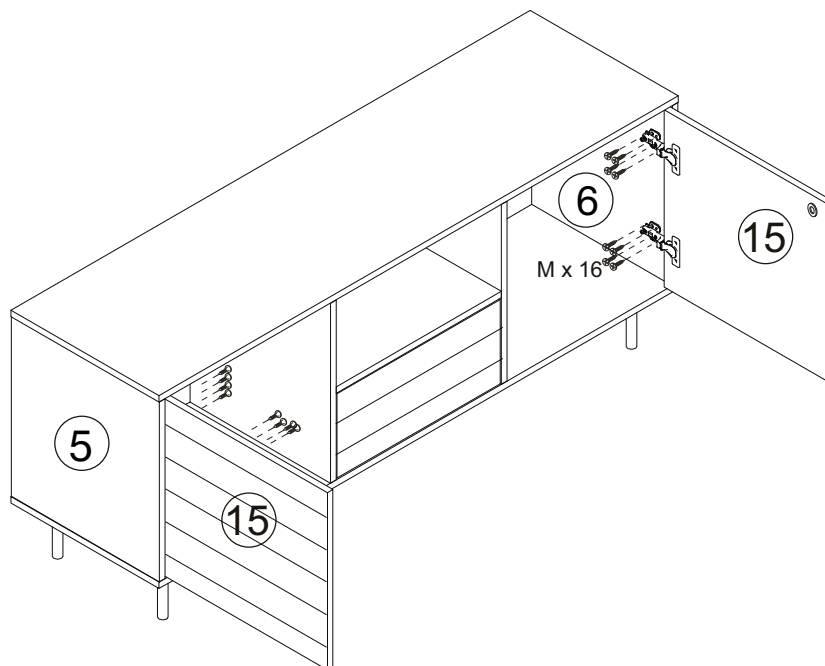
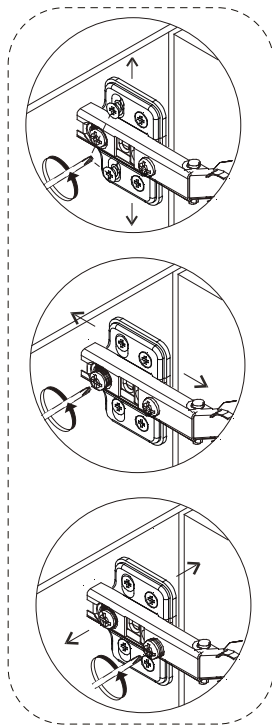
Step 14

Fix doors 15 to assembled unit using hinges and screws (M), as shown.



Mx16
 M4 x 14mm

VOILA!
Now enjoy.

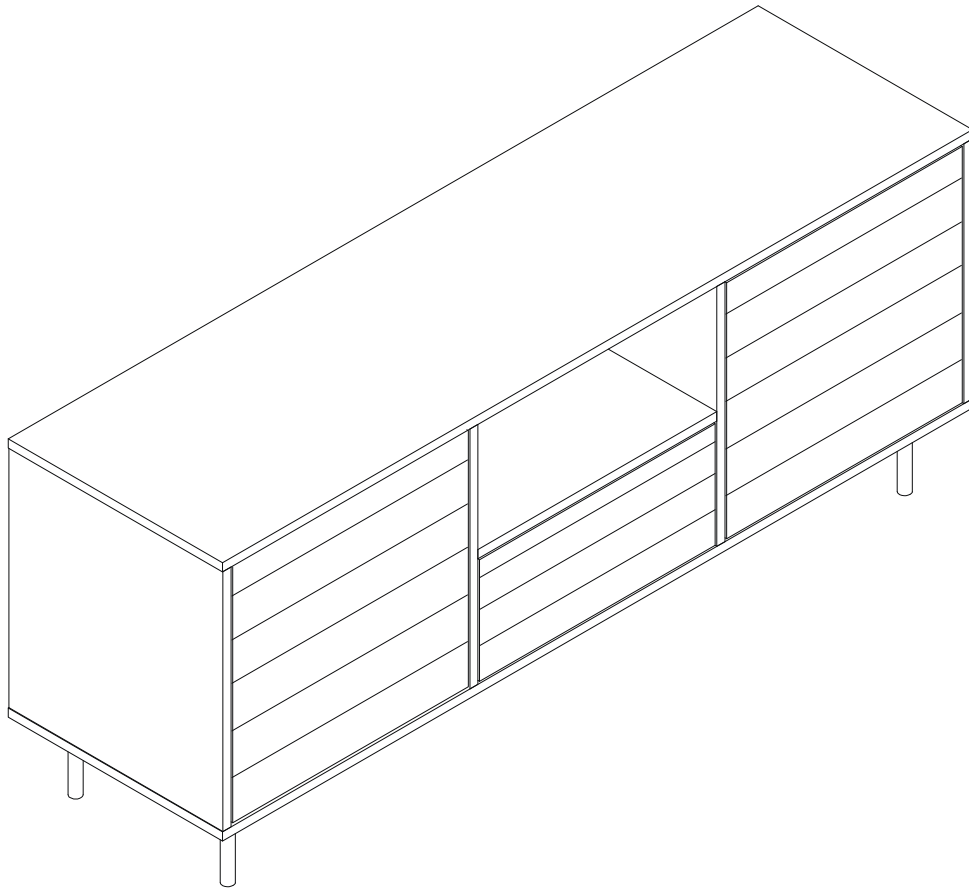

Warning

DO NOT sit or stand on the TV Stand as this may damage the product and cause serious bodily injury.

Something not right?

We are always here to help.

We make mistakes like every human does.

Though we always strive to provide the best possible products at competitive prices and the best service in the industry, it's not possible to completely eliminate mistakes. If you experience any dissatisfaction, feel free to contact us immediately. Our in-house customer care team will respond ASAP.



customerservice@luxenhome.com
Get response within 24 hrs



909.548.6688
Mon-Fri 9am-5pm PST/PDT



www.luxenhome.com/help
Submit a ticket on our website

Things to do to expedite the process

- Have your order# ready
- Take photos/videos to help us better identify the issues
- DO NOT throw away the packaging

Happy with our product?

Leave us a review

It really help us as a small business

- Find the product you purchased on our website (tip: search by SKU) and leave us a review.
- Alternatively, you can always return to the marketplace where you purchased it and leave a review there.

Share with others

Our customers look for REAL stuff



- Follow us on IG @luxen.home
- Share your #liveluxen moments



**Please save this manual
for future reference.**