

FLEXSTEEL®

Power Recliner with Power Headrest

IMPORTANT NOTE

Read these instructions carefully, and familiarize yourself with each procedure before assembling the furniture. Check that you have all the component parts, and familiarize yourself with each part before proceeding.

Take all the fittings out of the plastic bag and separate them into groups. Ensure you have enough space to lay out all the parts before assembly. To prevent damage to the parts, we recommend that you assemble the unit on a soft, level surface.

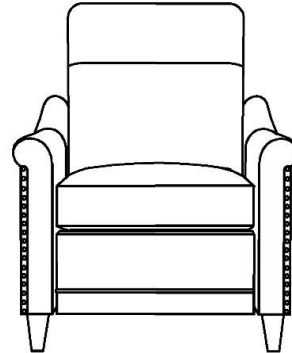

Part List

A.Back
1 piece

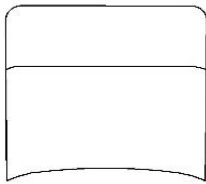

B.Seat
1 piece

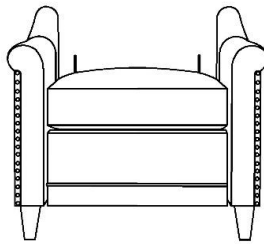

C.Transformer
1 piece



Assembly Instructions

STEP 1

Detach the transformer (C) from the back of the Seat (B). (See Figure 1.)

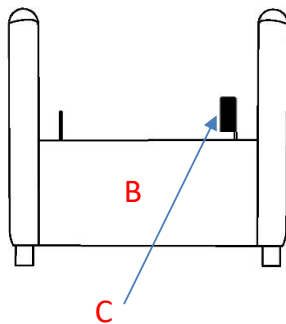

Figure 1

STEP 2

Lay the Back (A) face down on the Seat (B) and connect the headrest cable. (See Figure 2.)

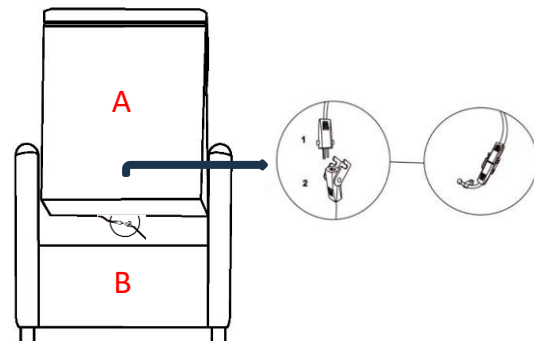

Figure 2

STEP 3

Attach the Back (A) to the Seat (B). Ensure the latches fit well. (See Figure 3.)

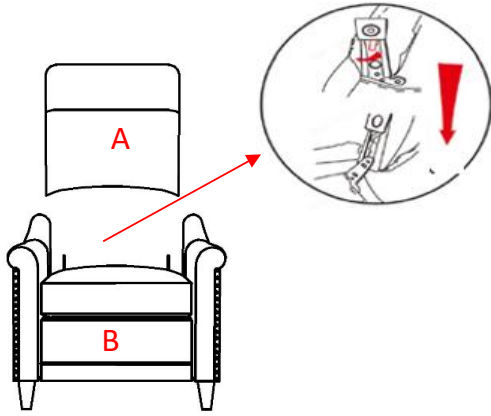

Figure 3

STEP 4

Zip the black fabric on bottom of Back (A) with Seat (B) . (See Figure 4)

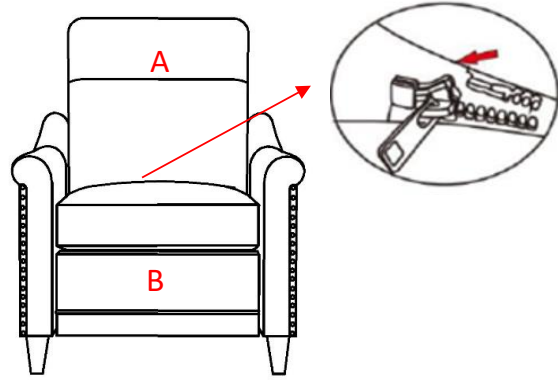

Figure 4

STEP 5

Connect the transformer with base motor cable connector , then plug the transformer into nearby power outlet (See Figure 5)

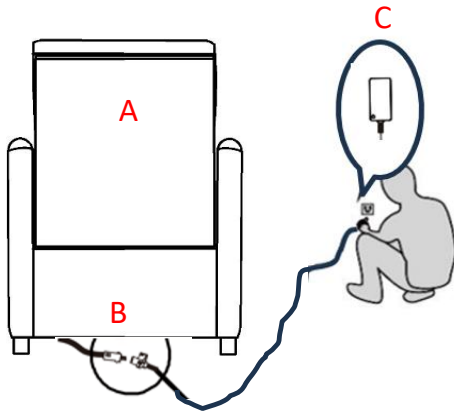
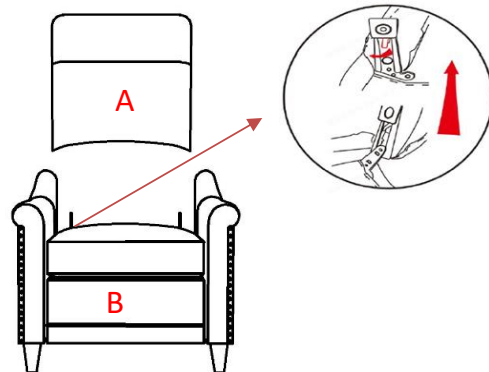

Figure 5

Disassembly instruction

To remove the back(s), unzip the zipper between the Back (A) and the Seat (B). Pull up on the leaf spring in the brackets on both sides of the back, and pull the Back (A) up. Then disconnect the headrest cable.



IMPORTANT NOTE

- To avoid any risk of suffocation to children or pets, dispose of all plastic bags immediately.
- To ensure proper performance, occasionally check for loose screws and tighten as needed.
- If the reclining functions are not working properly, check for loose cable connections before contacting the retailer.

FLEXSTEEL®

Power Reclining Loveseat with Power Headrests

IMPORTANT NOTE

Read these instructions carefully, and familiarize yourself with each procedure before assembling the furniture. Check that you have all the component parts, and familiarize yourself with each part before proceeding.

Take all the fittings out of the plastic bag and separate them into groups. Ensure you have enough space to lay out all the parts before assembly. To prevent damage to the parts, we recommend that you assemble the unit on a soft, level surface.

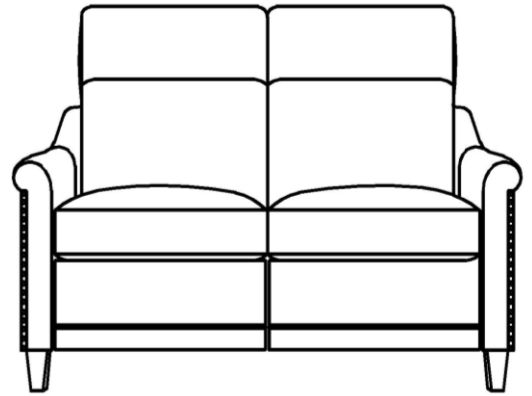

Part List

A:LAF BACK 1piece
B:RAF BACK 1piece

C.Seat
1 piece

D.Transformer
1 piece

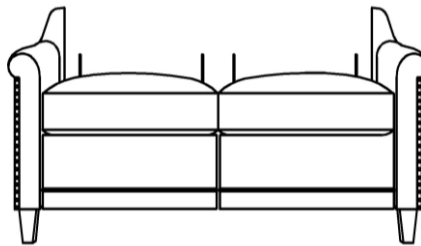
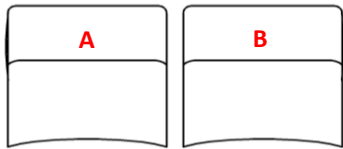

Assembly Instructions

STEP 1

Detach the transformer(D) from the Back of the Seat (C). (See Figure 1.)

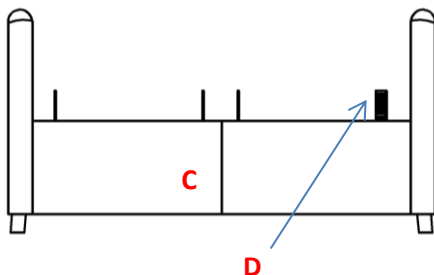

Figure 1

STEP 2

Lay the Backs (A&B) face down on the Seat (C) and connect the headrest cables to Backs(A&B). (See Figure 2.)

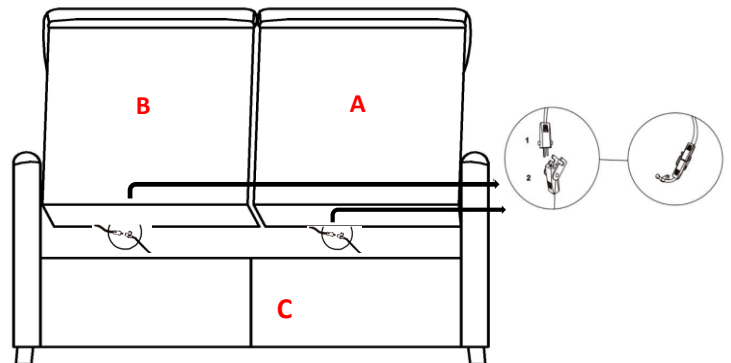

Figure 2

STEP 3

Attach the Backs(A&B) to the Seat (C).
Ensure the latches fit well. (See Figure 3.)

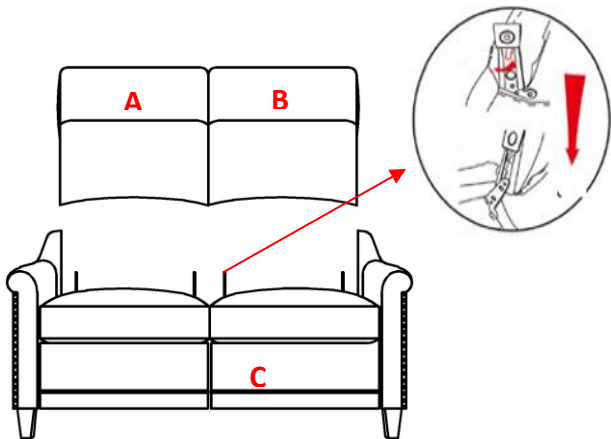

Figure 3

STEP 4

Zip the black fabric on bottom of Backs(A&B) with Seat (C). (See Figure 4)

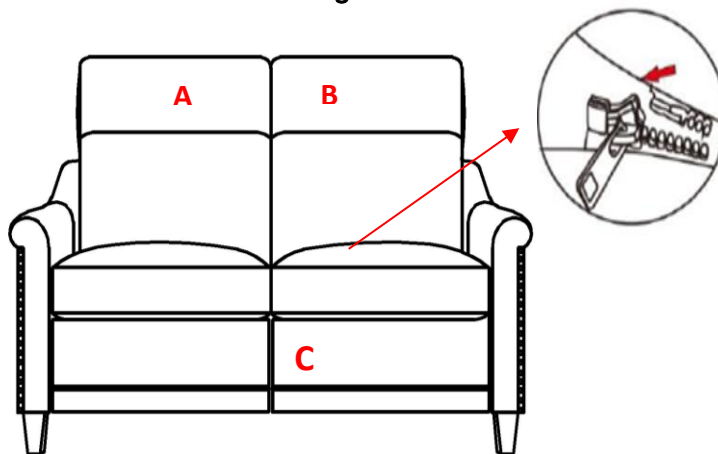

Figure 4

STEP 5

Connect the transformer with base motor cable connector , then plug the transformer into nearby power outlet (See Figure 5)

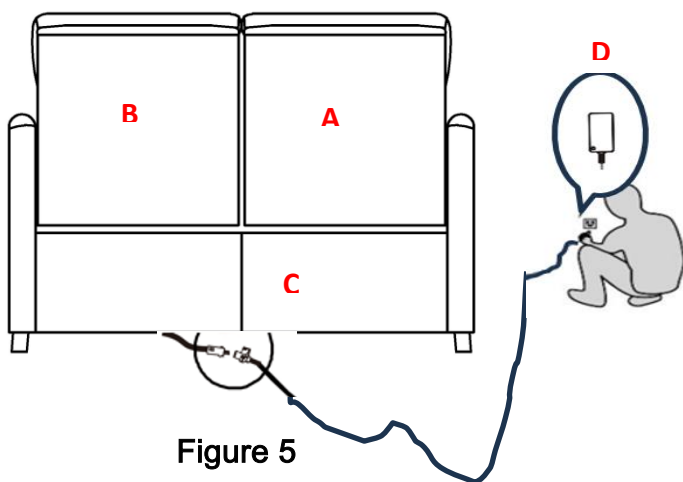
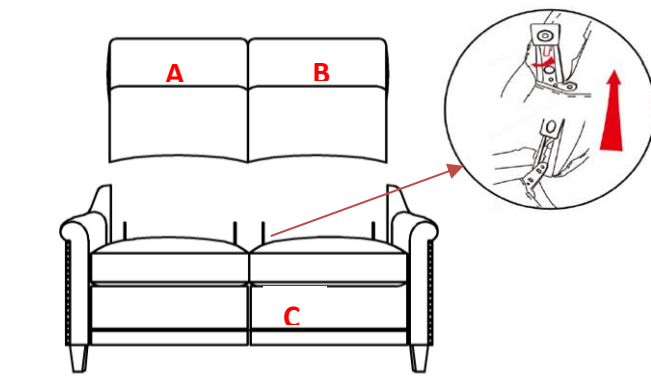

Figure 5

Disassembly instruction

To remove the Back(s), unzip the zipper between the Backs(A&B) and the Seat (C). Pull up on the leaf spring in the brackets on both sides of the back, and pull the Backs(A&B) up. Then disconnect the headrest cables.



IMPORTANT NOTE

- To avoid any risk of suffocation to children or pets, dispose of all plastic bags immediately.
- To ensure proper performance, occasionally check for loose screws and tighten as needed.
- If the reclining functions are not working properly, check for loose cable connections before contacting the retailer.

FLEXSTEEL®

Power Reclining Sofa with Power Headrests

IMPORTANT NOTE

Read these instructions carefully, and familiarize yourself with each procedure before assembling the furniture. Check that you have all the component parts, and familiarize yourself with each part before proceeding.

Take all the fittings out of the plastic bag and separate them into groups. Ensure you have enough space to lay out all the parts before assembly. To prevent damage to the parts, we recommend that you assemble the unit on a soft, level surface.

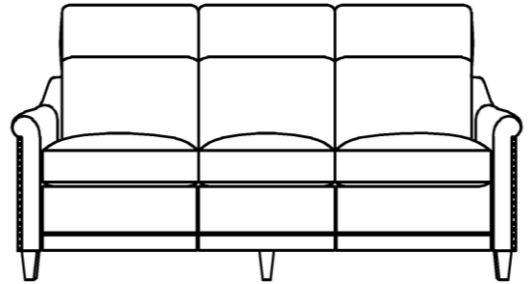

Part List

- A: LAF BACK 1piece
- C: CET BACK 1piece
- B: RAF BACK 1piece

D.Seat
1 piece

E.Transformer
1 piece

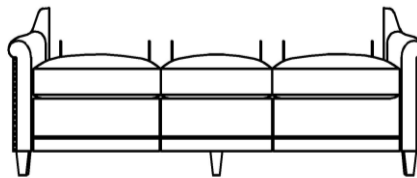
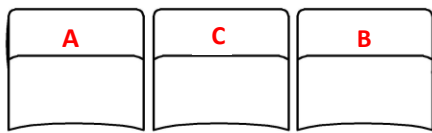

Assembly Instructions

STEP 1

Detach the transformer(E) from the back of the Seat (D). (See Figure 1.)

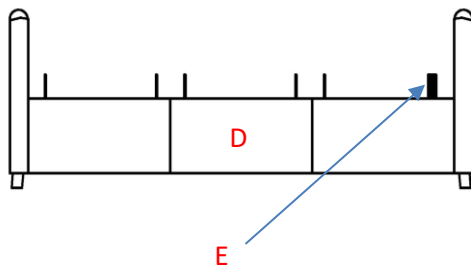

Figure 1

STEP 2

Lay the Backs(A&B&C) face down on the Seat (D) and connect the headrest cables to Backs(A&B). (See Figure 2.)

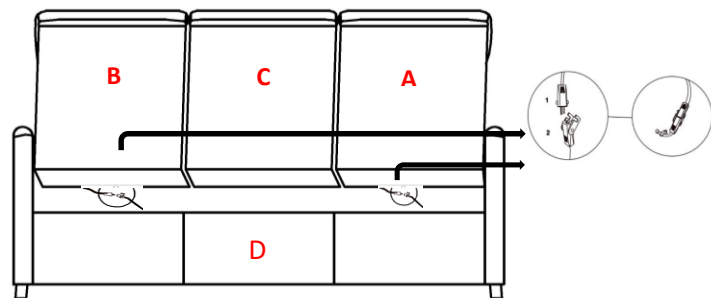

Figure 2

STEP 3

Attach the Backs(A&B&C) to the Seat (D). Ensure the latches fit well. (See Figure 3.)

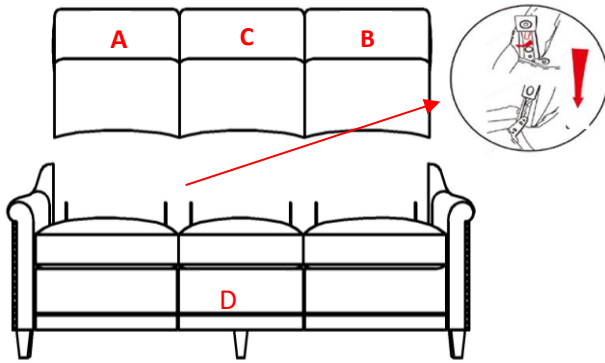

Figure 3

STEP 4

Zip the black fabric on bottom of Backs(A&B&C) with Seat (D) . (See Figure 4)

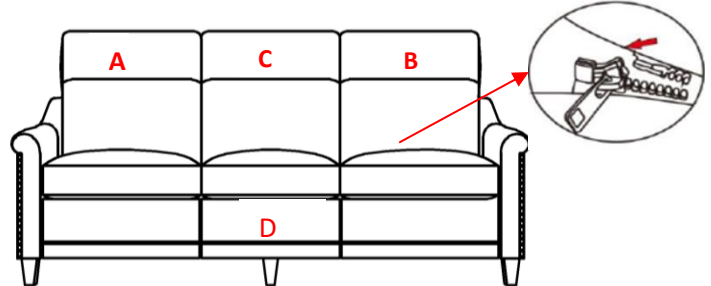

Figure 4

STEP 5

Connect the transformer with base motor cable connector , then plug the transformer into nearby power outlet (See Figure 5)

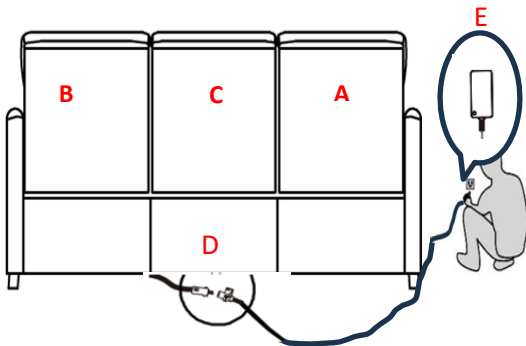
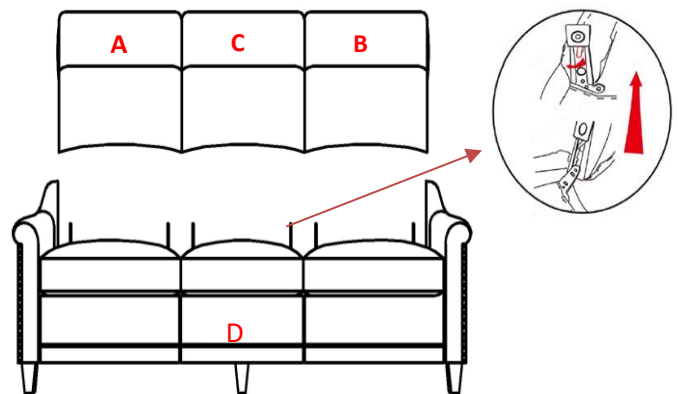

Figure 5

Disassembly instruction

To remove the Back(s), unzip the zipper between the Backs (A&B&C) and the Seat (D). Pull up on the leaf spring in the brackets on both sides of the back, and pull the Backs (A&B&C) up. Then disconnect the headrest cables to backs A&B.



IMPORTANT NOTE

- To avoid any risk of suffocation to children or pets, dispose of all plastic bags immediately.
- To ensure proper performance, occasionally check for loose screws and tighten as needed.
- If the reclining functions are not working properly, check for loose cable connections before contacting the retailer.