

Installation Manual-BV C11428 GWH

MOTIVATE
YOUR LIFE !

THANKS FOR WATCHING

Your feedback is invaluable to us and we would love to hear about your experience. Please take the time to leave us a review.

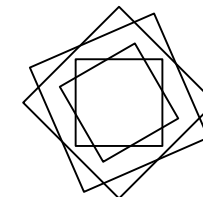
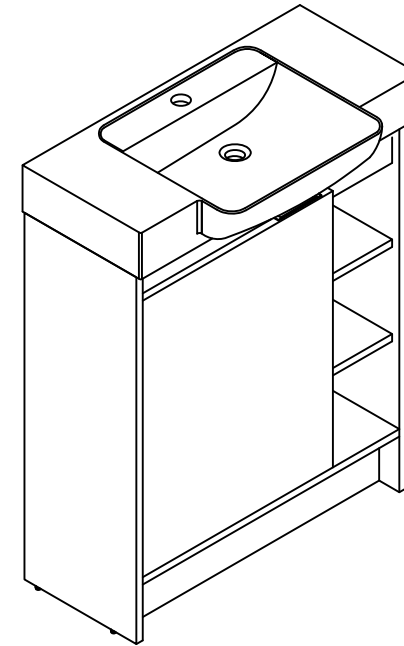













Thank you for shopping with us!

We encourage you to take a few minutes to go through this booklet. It contains important information on installation and care tips to keep your furniture looking as good as new.

Item NO.:BV C11428 GWH

Hardware

NO.	Draw	QTY	NO.	Draw	QTY
A	 Screws Ø4x14mm	32	H	 Bracket (19x19x35mm)	2
B	 Two-in-one connector	42	I	 Hinges(Internal hiding)	2
C	 Two-in-one connector	42	J	 Adjustable feet	4
D	 Wood plug	9	K	 Movable laminate support	4
E	 Plastic anchor(Ø10mm)	2	L	 Anti-collision gasket	2
F	 Screws for fix on the wall	2	M	 Screwdriver	1
G	 Bracket (53x70x44mm)	2			

Recommended tools

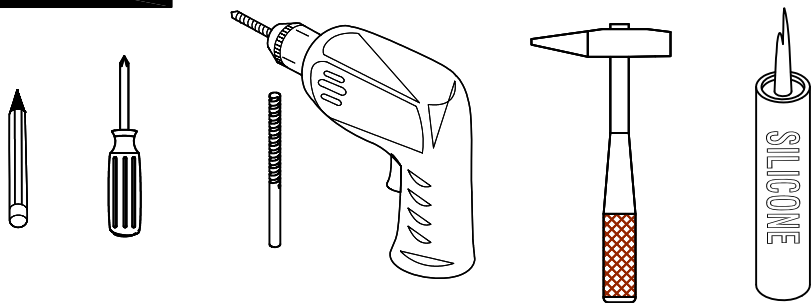

Dimensions

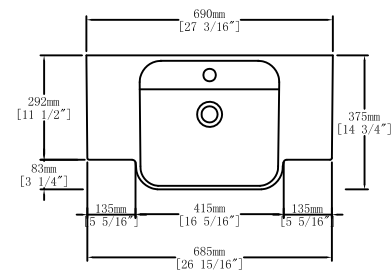

Top View

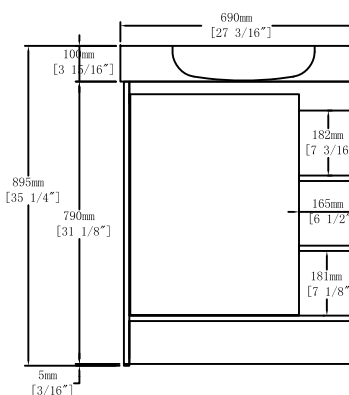

Front View

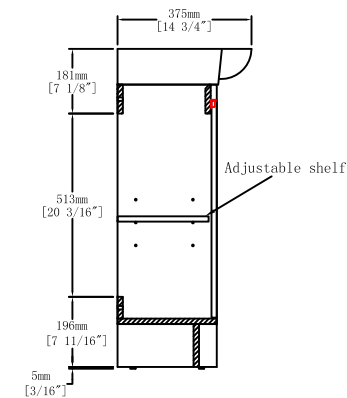

Side View

CARE CLEANING AND MAINTENANCE

1. Dust regularly with a soft , dry cloth.
2. Avoid the use of all chemicals household cleaners, abrasives, or cleaners that contain lemon, vinegar, or other acids that may damage the finish.
3. Excessive exposure to sunlight and extreme changes in temperature and moisture can damage wood furniture.
4. The sink is fragile, please pay attention to maintaining its appearance.
5. Do not place hot appliances, such as curling irons and hot hair dryers directly on the countertop. Wipe spills immediately.

Step 1

Notes: Screw installation depth as shown

Attention: Cam lock arrow point to the steel rod.

- B x3
- C x3
- M

Step 2

Note: The D parts are used for these two holes

first step second step third step

- B x4
- C x4
- D x2
- M

Step 12

Notes: Screw installation depth as shown

- E x2
- Tool

Step 13

Notes: Screw installation depth as shown

- F x2
- Tool

Step 9

You can adjust the doors by tightening or loosening the screws on the hinge. →

I	x2
(Ø4 x 14mm)	x12
A	x2
L	x2
Tool	

Step 3

Note: The D parts are used for this hole

B	x4
C	x4
D	x1
Tool	M

Step 10

Tool

Step 11

Tool

Ø10

Step 4

B	x3
C	x3
Tool	M

Step 5

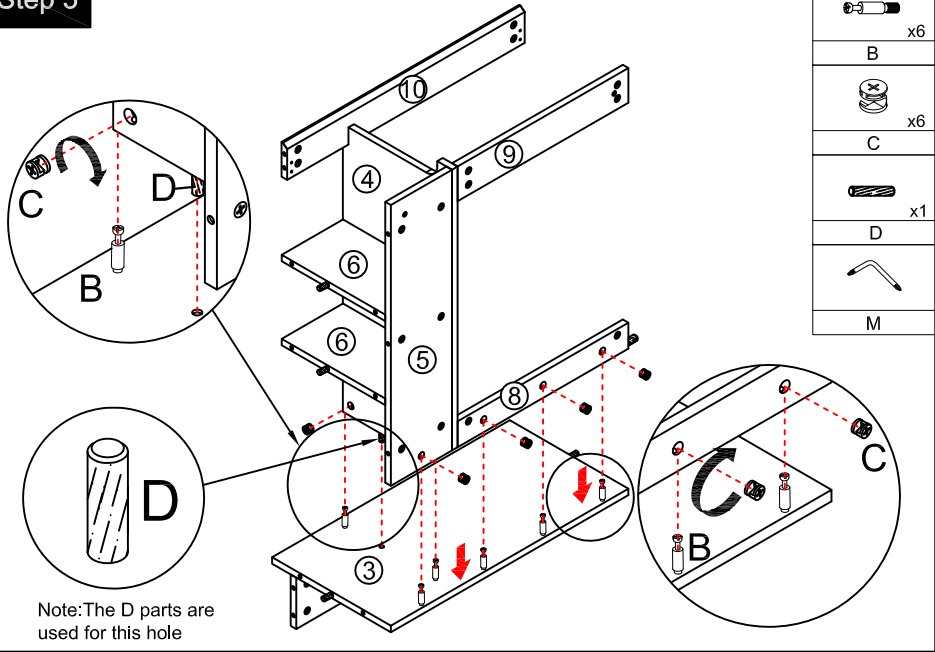

Step 7

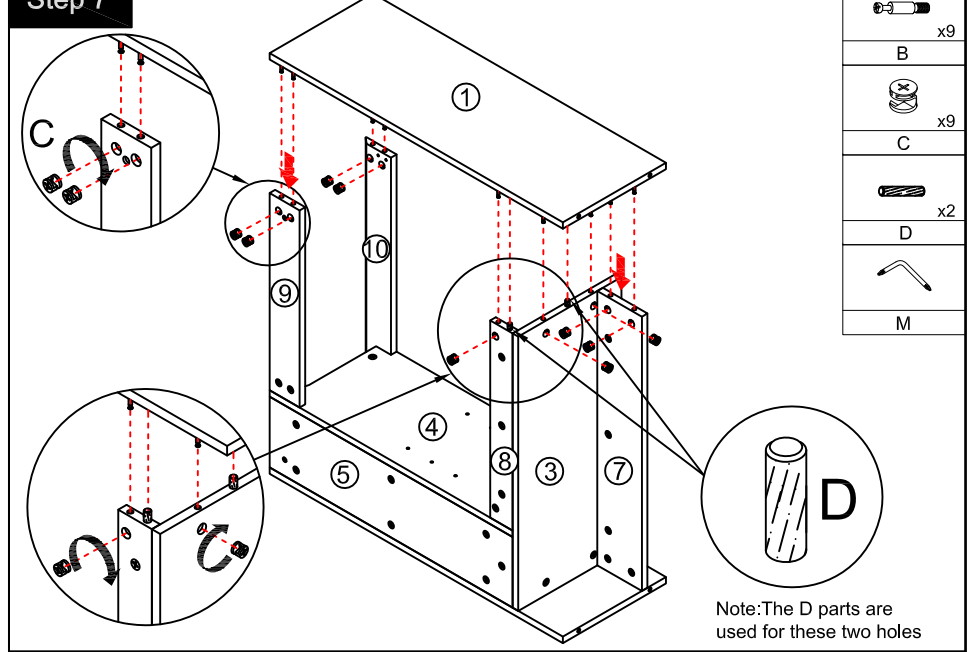

Step 6

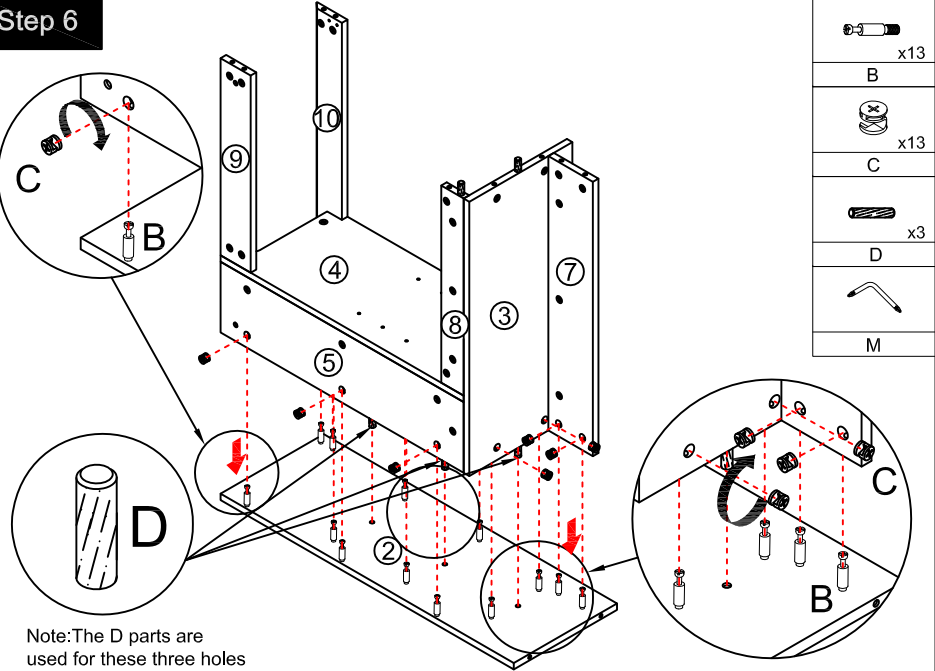

Step 8

