

1200W Portable Under Table Mini Electric Heater

with Removable Double-cover
Tempered Glasses

Owner's Manual UTH22001

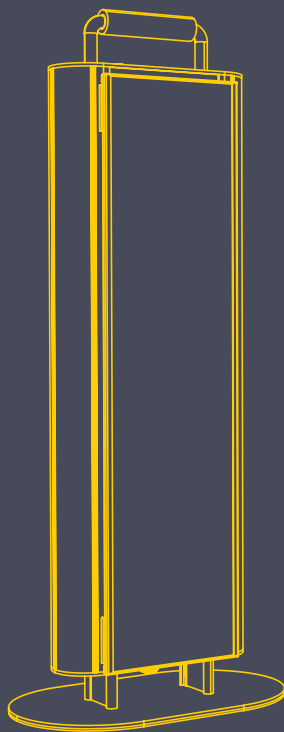

EAST OAK

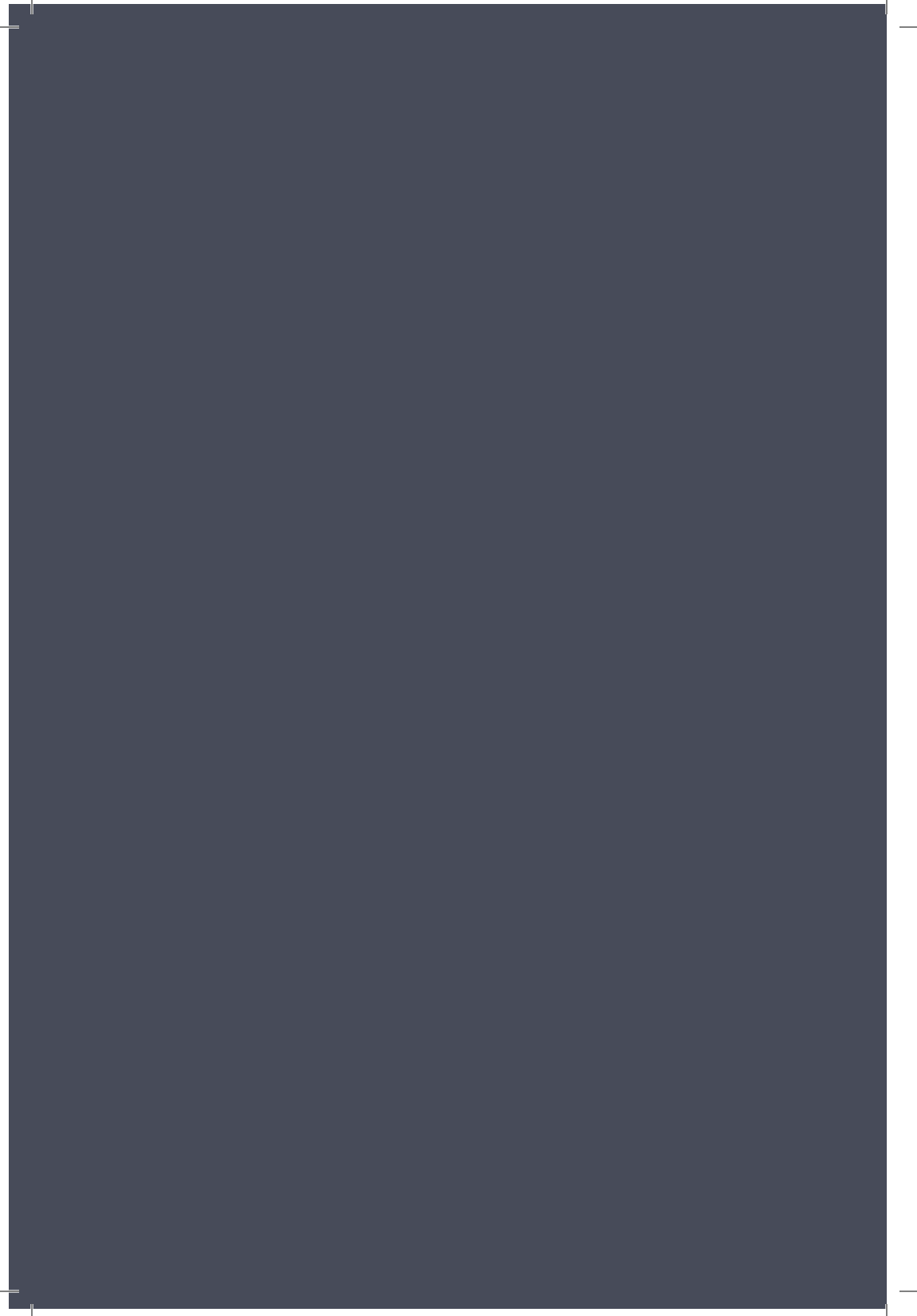

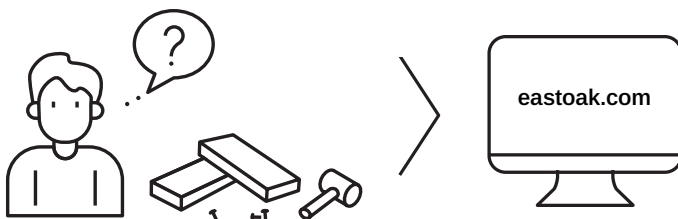

**Question? Comments?
Reach out to us to get expert support!**

✉ support@eastoak.com
🌐 eastoak.com
☎ 1-833-EAST-OAK (USA)
(1-833-327-8625)

Follow **eastoakliving** on



Claim 3-year warranty
at eastoak.com/warranty

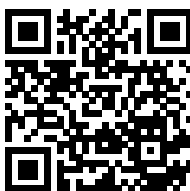

IMPORTANT CAUTION

Please verify all parts and components present and check for any damaged pieces before assembly. If you have any damaged or missing parts, please contact customer service at support@eastoak.com.

- Some parts may contain sharp edges and may cause injury or property damage. We recommend you wear protective gloves during assembly.
- If you are using power tools, please set the speed to the lowest setting possible to ensure there will be no damage to the parts.



IMPORTANT INFORMATION

DANGER

- To avoid any overheating, do not cover this product when it is in use.
- **This appliance shall be used by adults only.** Any child under the age of 8 years old or persons with reduced physical, sensory, or mental capacity may use this product if given proper supervision and instruction concerning the best practices and safety measures of the appliance. Children should not play with or clean this product.

CAUTION

- This product is **extremely hot when in use** and may cause burns, injury, or death. Children and vulnerable people should remain at least 3 feet away from this product.
- This heater cannot control room temperatures. **Do not use this heater in small rooms with children or pets.**
- This heater must not be placed immediately below a socket outlet.
- Do not place this heater close to any combustible items, such as curtains, cloth, gas, or any flammable liquids.

-
- If the cord or plug is damaged, please contact support@eastoak.com to repair and/or replace the part. Do not attempt to operate this heater prior to replacement.
 - Children under 3 years old should stay away from this product when in use unless closely supervised.
 - Children ages 3 to 8 years old shall not operate this appliance, plug or unplug it into the outlet, clean, or perform any maintenance on this product.



SAY HELLO TO THE FUTURE

Our Infrared Electric Heater offers maximum heat with 90% less light, creating an ambient and pleasurable outdoor experience for all. Its ultra-low glare technology promises instant comfort in a matter of seconds. And to set up – all you need is at least 5 minutes, because we’ve designed each heater with a patented easy-fit replacement system. Plus, its remote controlled and IP 65 approved.

Welcome warmth and the perfect amount of heat into your life now with East Oak’s Infrared Heater.



SAFETY GUIDE

When using any electrical appliance, including this infrared heater, basic safety precautions must be followed to reduce the risk of fire, shock, or injury. Please read all instructions before using this appliance:

- This heater becomes extremely hot when in use. To minimize risk of burns or injury, do not touch any part of the heater when in use. Allow enough time for product to cool down completely before handling. If applicable, use handles when transporting this product. Keep all combustible items, such as furniture, pillows, bedding, or paper, at least 3 feet away from all sides of the heater.
- Be extremely cautious of surroundings when heater is in use. No children or pets should be close to the product when it is on.
- Ensure heater is unplugged after each use.
- Do not operate this heater if it malfunctions, has been dropped, or any cords or plugs are damaged. Discard heater or send the product to an authorized service facility for inspection and/or repair.
- Do not run the cord under any carpeting, rugs, furniture, or appliances. Ensure the cord is neatly placed away from areas that are high-traffic and may be tripped over.
- Connect to properly grounded outlets only.
- To disconnect the heater, turn the switch to the "OFF" position. Then, remove the plug from the outlet. Allow the product to cool down completely.
- Do not insert any foreign objects into the ventilation system. This may result in a fire, shock, or damage to the heater.
- For fire prevention, do not block any air intakes or exhausts with any items, including newspapers, cloths, or curtains. Do not use this appliance on top of soft surfaces, such as a bed or clothes.
- Do not place any open flame sources on this appliance, such as a lit candle.
- Do not place this appliance near any combustible materials, such as gas, paint, or flammable liquids.
- Only use this heater as described in the manual. Any other use is not recommended by the manufacturer. Be aware that misuse may result in fire, shock, or injury.
- Only plug the heater directly into a grounded outlet with protective connection. Do not use this appliance with an extension cord or power strip.
- Always check the voltage on the name plate of the appliance with the outlet you will be inserting it into.
- The appliance is not located immediately below a wall socket-outlet.

-
- All parts of this heater may become extremely hot when in use. Do not touch the appliance and ensure there is no combustible material around the product. Misuse may result in fire, shock, damage, or injury.
 - In case of an emergency, such as shock or fire, turn off the heater and unplug the appliance immediately. Do not try to repair the product by yourself. Please contact the manufacturer or a qualified electrician.
 - Unplug the appliance and wait until the heater has completely cooled down prior to cleaning or transporting.
 - The appliance must only be mounted by an authorized specialist. Please be aware of any relevant regulations from local electric companies or regional construction organizations.

STORAGE

Do not move, reroute, or wrap cord when heater is in use.

CARE AND MAINTENANCE

- This appliance is designed with a protective aluminum exterior for added durability and low maintenance use. No serviceable parts are included.
- Prior to cleaning your product, unplug the device and wait for it to completely cool down.
- Wipe your product with only a clean, lint-free cloth or a soft bristle brush.
- Do not clean your product with any abrasive cleaners, rough brushes, or chemical products.
- If needed, you may use alcohol to clean this product.
- For your safety, do not immerse the cord, plug, or any part of the product in water or any other liquid.
- If a replacement is needed, please contact the manufacturer or a qualified electrician.
- If a replacement is needed, please contact customer service at support@eastoak.com.

SAVE THESE INSTRUCTIONS

Specifications	
Specification	UTH22001
Voltage (V)	120V 60Hz
Power consumption (W)	1200W
IP code	IP65

FUNCTION INSTRUCTION

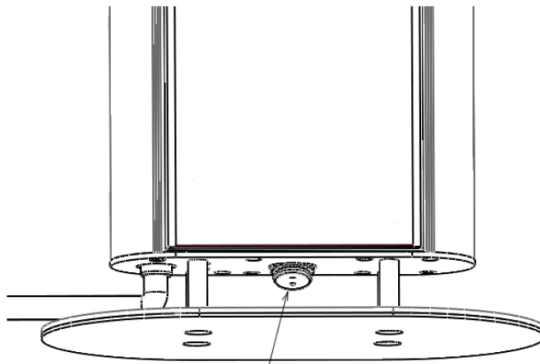

A **Switch**
Turn on the power or Turn off the power

1

OPERATION INSTRUCTION

Use the heater according to the following steps:

Open the package and remove all parts and materials. Ensure all pieces are present and working. Check the heater body, heater stand, wire cables, and plug for any damage. If damage is present, please contact our customer support and do not continue assembly.

If any parts or hardware pieces are missing or damaged, please contact customer service at support@eastoak.com. In your email, include your shipping address and product purchased. We will send you replacement parts for free.

2

Place the product on the ground vertically. Connect the plug to a socket for electrical power. Make sure the socket and plug is not wet.

3

Turn the switch to the “ON” position. The heater should begin heating up.

4

If the glass baffle must be removed, turn off the heater and allow it to cool.

- Unscrew the two screws on the upper cover plate by about 10 mm.
- Hold the glass frame with both hands. To remove the plate, lift up and pull out.
- Tighten the two screws to secure the plate.

Unscrew the two screws on the left side by approximately 10 mm. Do not unscrew all the way.

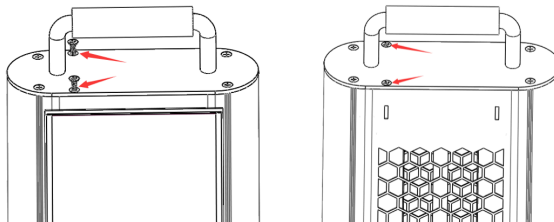
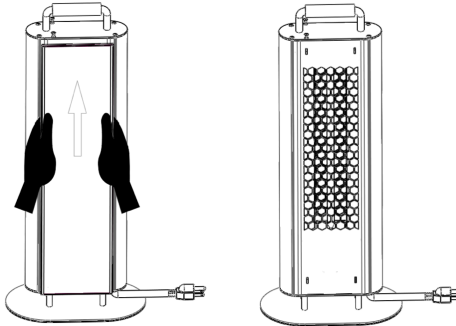
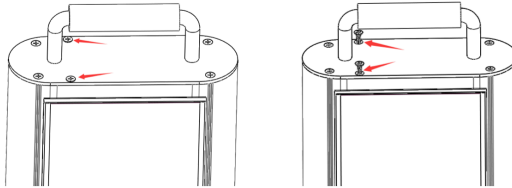

5

If the glass baffle needs to be installed, reverse steps 4a - 4c.
Do not move or cover the appliance when it is in use.

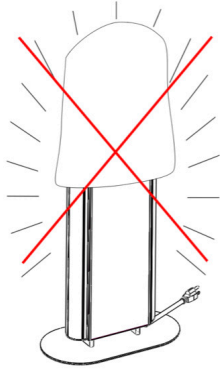

- Inspect the mount and all mounting pieces, such as dowels and screws. Make sure they are secured tightly to lengthen the product's lifespan.
- Do not add excessive weight to the appliance.
- Adjust your heater to your desired angle. Then, fasten all screws tightly. Regularly check your screws and tighten if needed.
- Plug your heater to a power source, then turn the switch to the "ON" position. Assess the product for at least 15 minutes to ensure there are no problems.

GROUNDING INSTRUCTIONS

This heater is compatible with 120 volt sockets. The plug (A) is shown Figure 60.1. An adapter (C) is available to adapt three-blade plugs to two-slot sockets. The green grounding extension must be connected to a permanent round, such as an outlet box. The adapter should not be used if a three-slot socket is available.

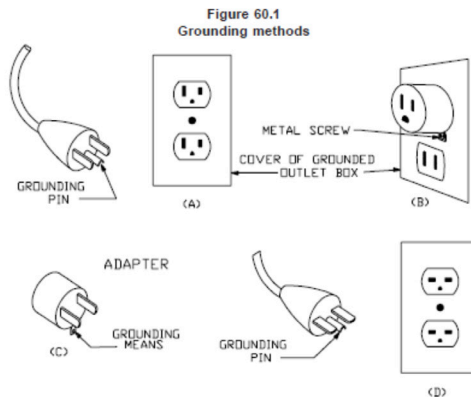

SERVICE

- For your safety, all repairs must be done by an authorized and trained electrician only.
- Please contact the manufacturer or an electrician for your choice.
- Unauthorized repairs may lead to property damage, injury, or death.
- Unauthorized repairs may lead to property damage, injury, or death.
- Our warranty does not cover any damage resulting from unauthorized repairs, accidents, misuse, or maintenance abuse.
- We are committed to continuous product development and we reserve the right to change the product and documentation specifications without notice.
- For any services, please contact customer service at support@eastoak.com.

WARRANTY

GUARANTEED 3-YEAR WARRANTY

Thank you for choosing East Oak. This product is covered by our company warranty for up to 3 years from its original purchase date.

CLAIM WARRANTY

If you'd like to claim your product's warranty, register your new product on our website at www.eastoak.com/warranty.

The first part of the document discusses the importance of maintaining accurate records of all transactions. It emphasizes that every entry, no matter how small, should be recorded to ensure the integrity of the financial data. This includes not only sales and purchases but also expenses and income. The document provides a detailed list of items that should be tracked, such as inventory levels, supplier payments, and customer orders. It also outlines the procedures for recording these transactions, including the use of specific forms and the assignment of responsibilities to different staff members.

The second part of the document focuses on the analysis of the recorded data. It describes various methods for identifying trends and anomalies in the financial performance. This includes comparing current data with historical records and industry benchmarks. The document also discusses the importance of regular reviews and reports to management, highlighting the need for transparency and accountability. It provides examples of how to present the data in a clear and concise manner, using charts and graphs to illustrate key findings.

The final part of the document offers practical advice on how to improve the efficiency of the record-keeping process. It suggests implementing standardized procedures and using technology to streamline data entry and reporting. The document also emphasizes the importance of training staff members on the correct use of the system and the consequences of inaccurate record-keeping. It concludes by reiterating the overall goal of the document: to ensure that the organization's financial records are accurate, complete, and reliable.

EAST OAK

✉ support@eastoak.com
🌐 eastoak.com
☎ 1-833-EAST-OAK (USA)