

METAL DAYBED

Metal Daybed







Examine all packaging material for small parts that may have come loose during shipment. Periodic checks are recommended to insure that all components are in proper position, tight and free from damage. Keep this assembly instruction for future reference. Adult assembly is required.

HARDWARE LIST

- A (16) Long Allen Bolts M6 x 60mm
- B (4) Short Allen Bolts M6 x 25mm
- C (8) Spring Washers
- D (8) Flat Washers
- E (8) Hex Nuts
- F (1) Allen Wrench

PARTS LIST

- G (2) Side Panels
- H (1) Back Panel
- J (2) Long Posts
- K (2) Short Posts
- L (4) Top Finials

PART	QTY	HARDWARE	PART	QTY	HARDWARE
A	16		B	4	
C	4		D	8	
E	8		F	1	

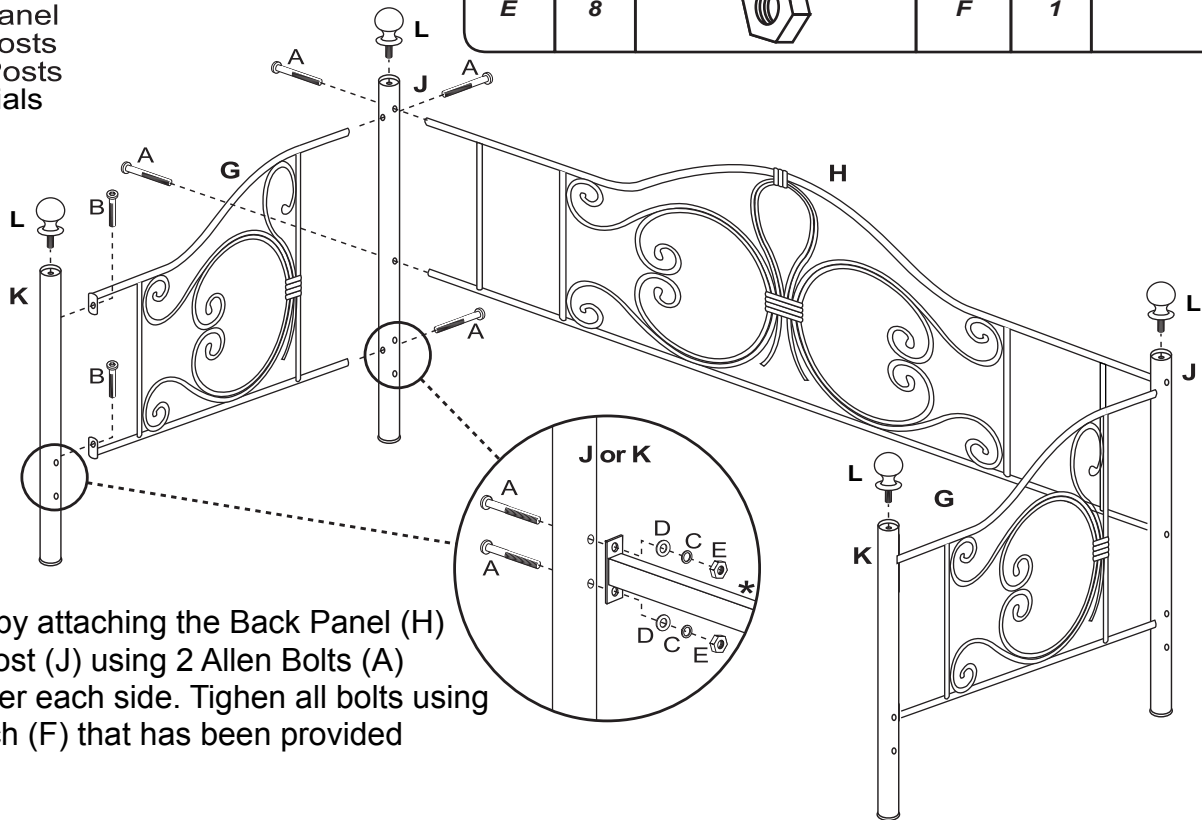

STEP 1

Begin assembly by attaching the Back Panel (H) to each Long Post (J) using 2 Allen Bolts (A) from the side, per each side. Tighten all bolts using the Allen Wrench (F) that has been provided

STEP 2

Attach each Side Panel (G) to each Long Post (J) using 2 Allen Bolts (A) from the backside, per each side. Tighten all bolts.

STEP 3

Attach each Short Post (K) to each Side Panel (G) using 2 Short Allen Bolts (B) from the inside, per each side. Tighten all bolts.

STEP 4

Attach each Finial (L) to the top of each Post (J) & (K) by carefully screwing into place. Do not overtighten to prevent stripping of the threads.

STEP 5

Finally, attach the Link Spring (*Not Included) to each post on the inside using 2 Long Allen Bolts (A) from the outside, and 2 Flat Washers (D), 2 Spring Washers (C) & 2 Hex Nuts (E) pre each post. Tighten all bolts. The assembly of your new daybed is now complete.

CARE & MAINTENANCE: The touch of a soft cloth is all the maintenance the finish will ever need. Please do not use harsh or abrasive cleaners for polishing, as they may cause damage to the finish. Periodic checks are recommended to make sure that all bolts, screws and nuts are securely tightened.