

Before the Installation

1. Do not throw away packing materials until assembly is complete for small parts may come loose inside the carton during shipment, If parts are missing, please contact us.
2. Assemble this item on a soft surface, such as carpet to protect the finish.
3. Proper assembly of this item requires 2 people.
4. Do not fully tighten the screws during initial assembly. Fully tighten screws only once all pieces which are correctly assembled.
5. If you encounter any problems during installation, refer to two solutions: Follow the installation product page or contact our customer service.
6. A Philips head screwdriver and hammer is required for the assembly of this product.
7. Power tools should not be used to assemble this product.

Care and Cleaning

1. Move your product carefully, with 2 people lifting it to the preferred location .
2. To protect the finish, avoid use chemicals and household cleaners.
3. All hot serving dishes should be placed on a pad.
4. Any liquid spilled onto the top should be cleaned up immediately with a dry cloth.

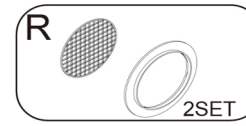
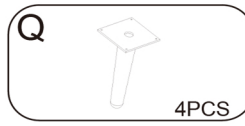
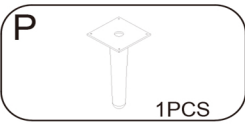
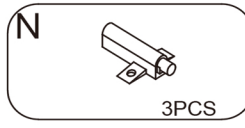
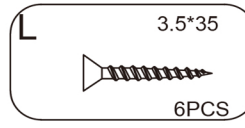
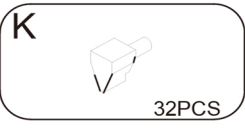
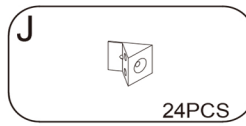
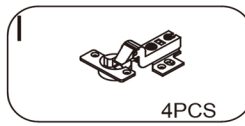
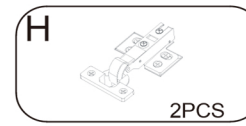
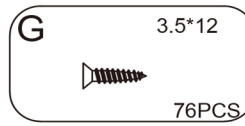
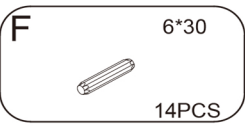
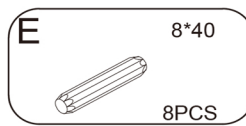
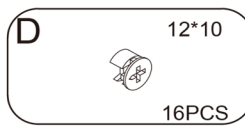
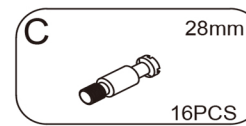
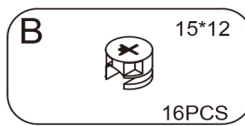
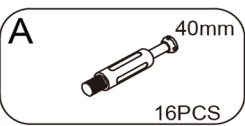
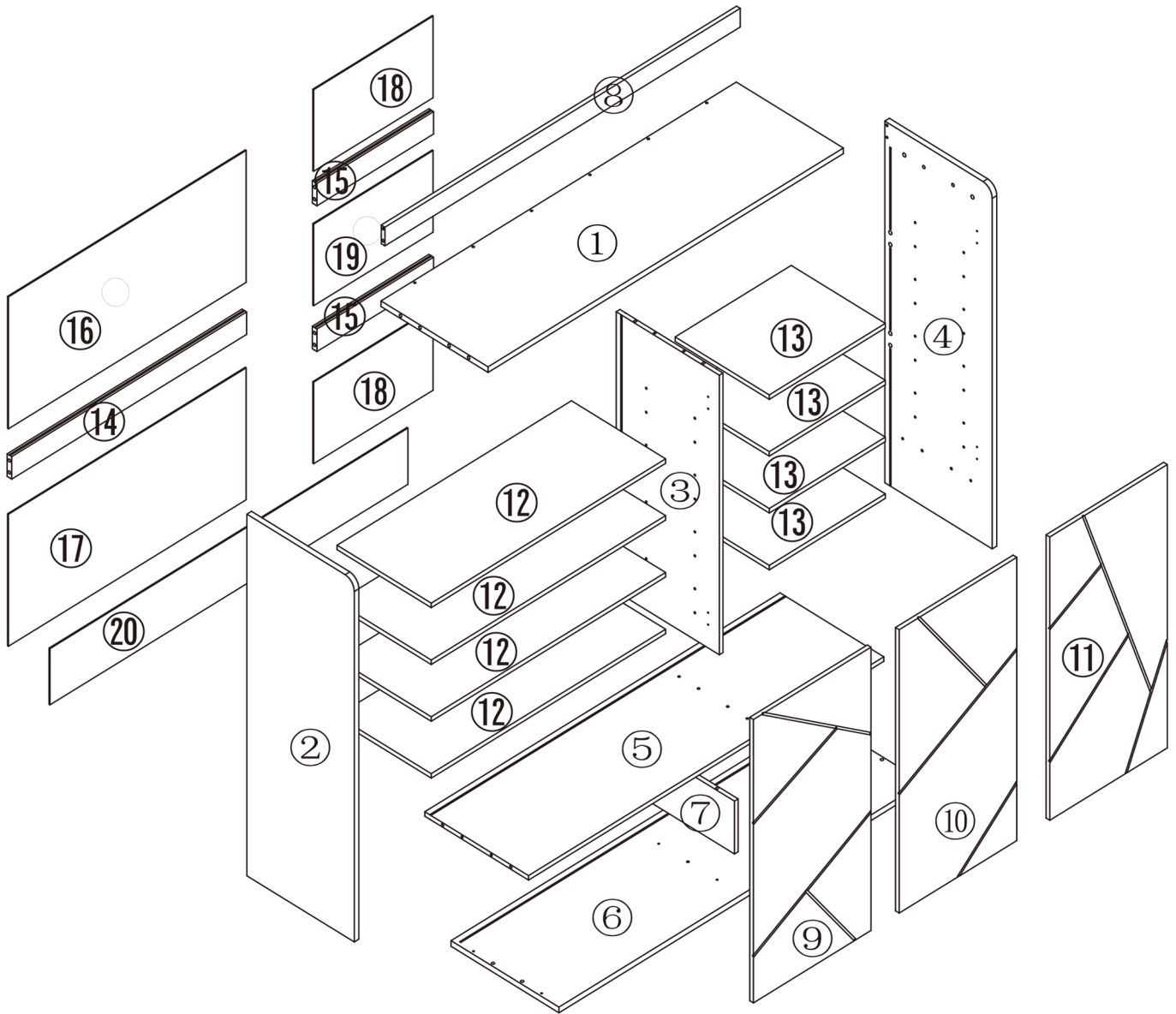



Pay attention to the difference between the middle parts of the two types of door hinges.

The full coverage door hinges(I) are used on outermost door panel NO.9 & NO.11 .

The curved door hinges(H) are used on the door panel in the middle of the cabinet NO.10 .

I

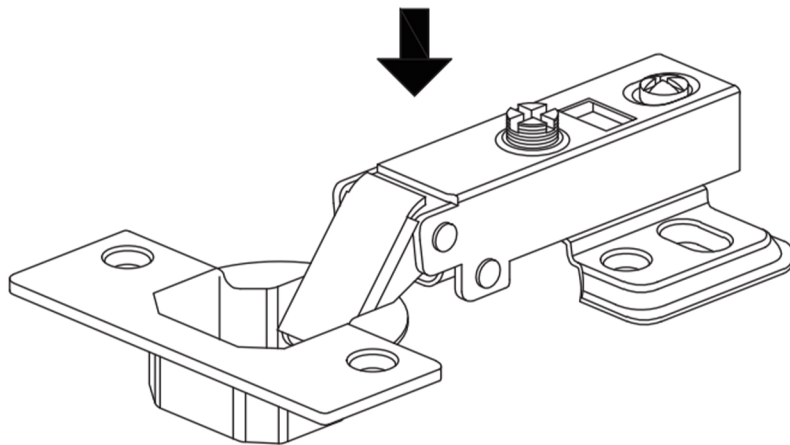

H

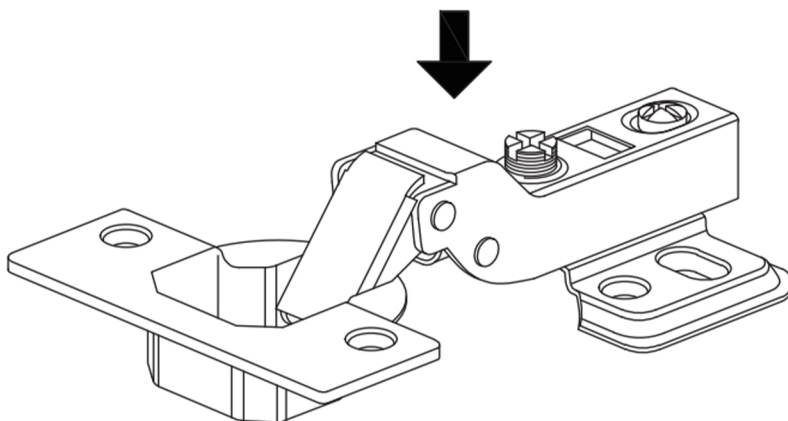

STEP 1

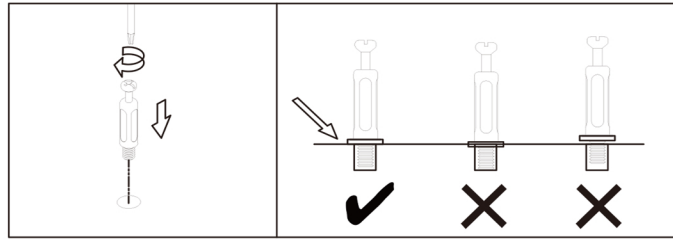

- C** 28mm
4PCS
- D** 12*10
4PCS
- F** 6*30
2PCS
- G** 3.5*12
18PCS
- H**
2PCS
- I**
4PCS
- N**
3PCS

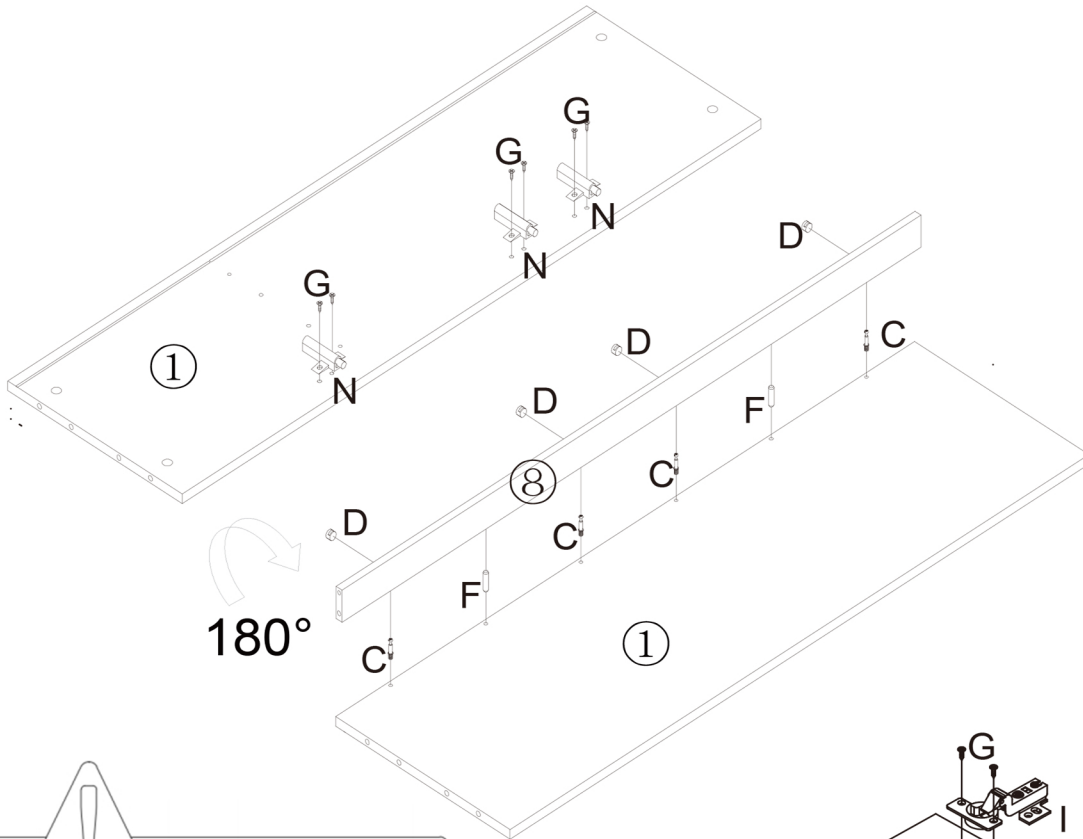

When installing hinge, please pay attention to distinguish the category of hinge!!!!

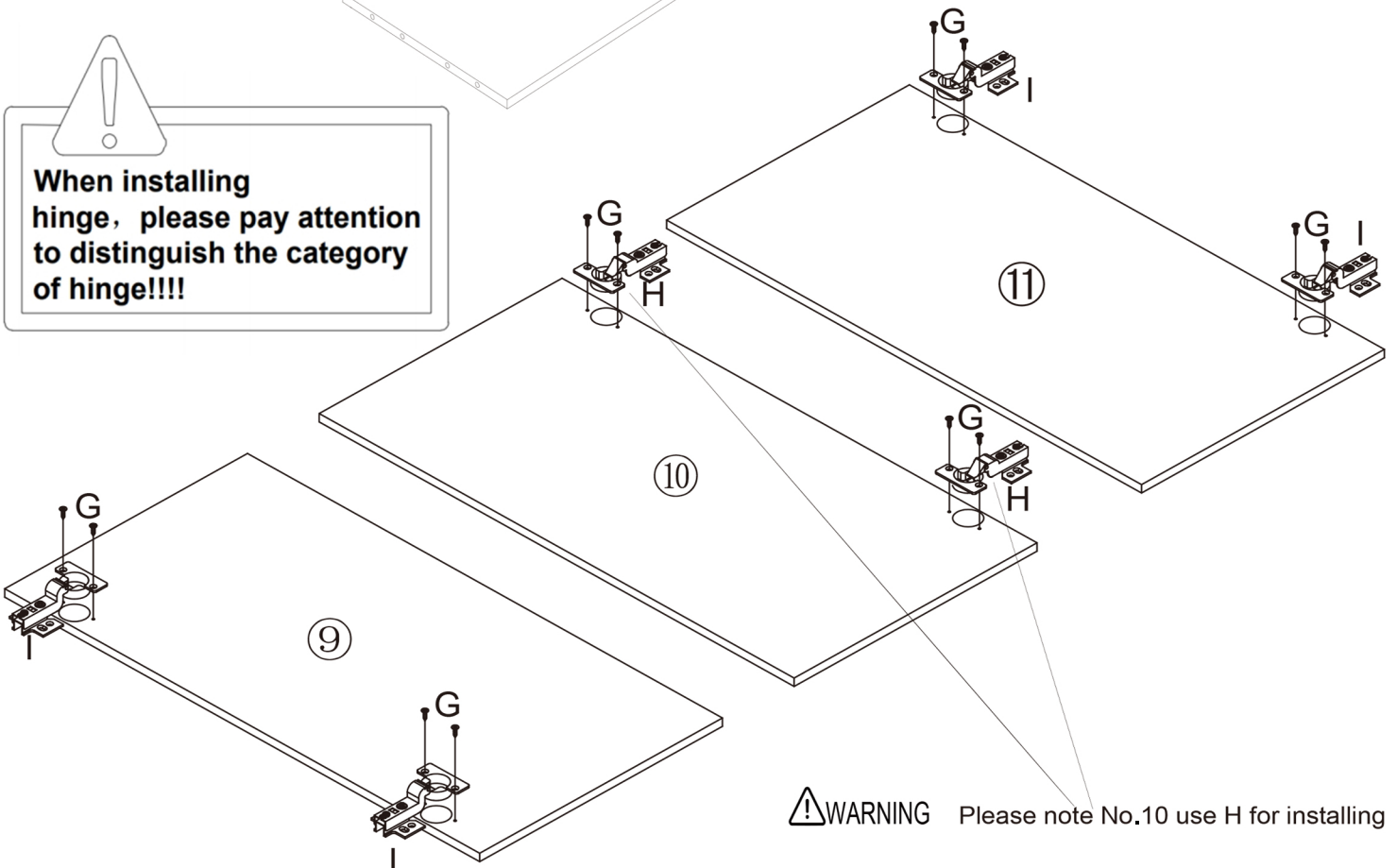

!WARNING Please note No.10 use H for installing

STEP 2

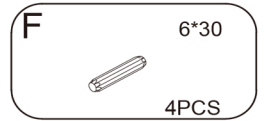
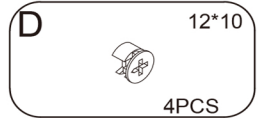
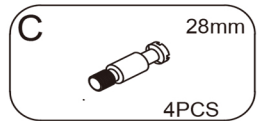
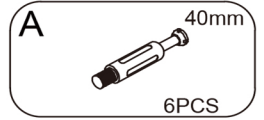
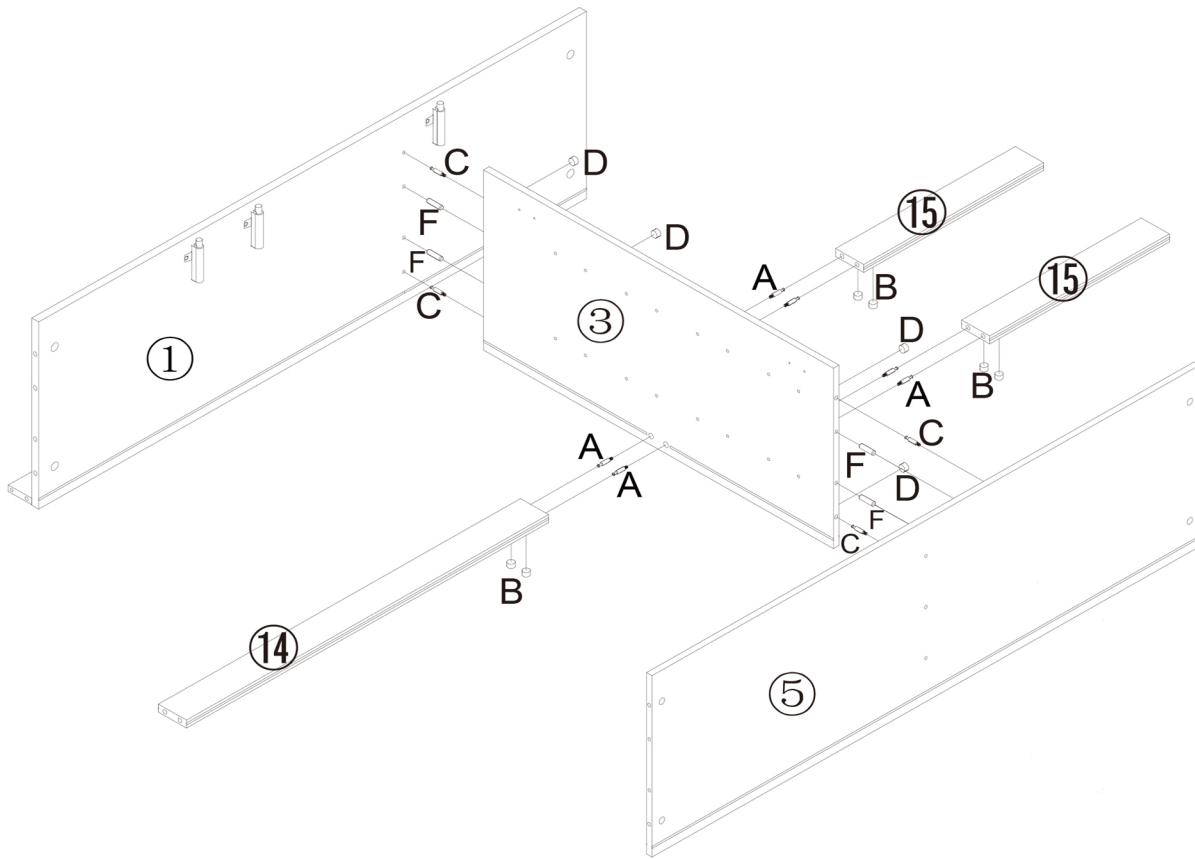

STEP 3

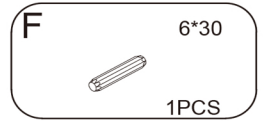
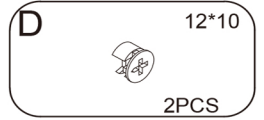
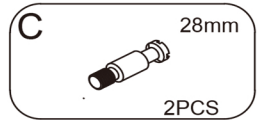
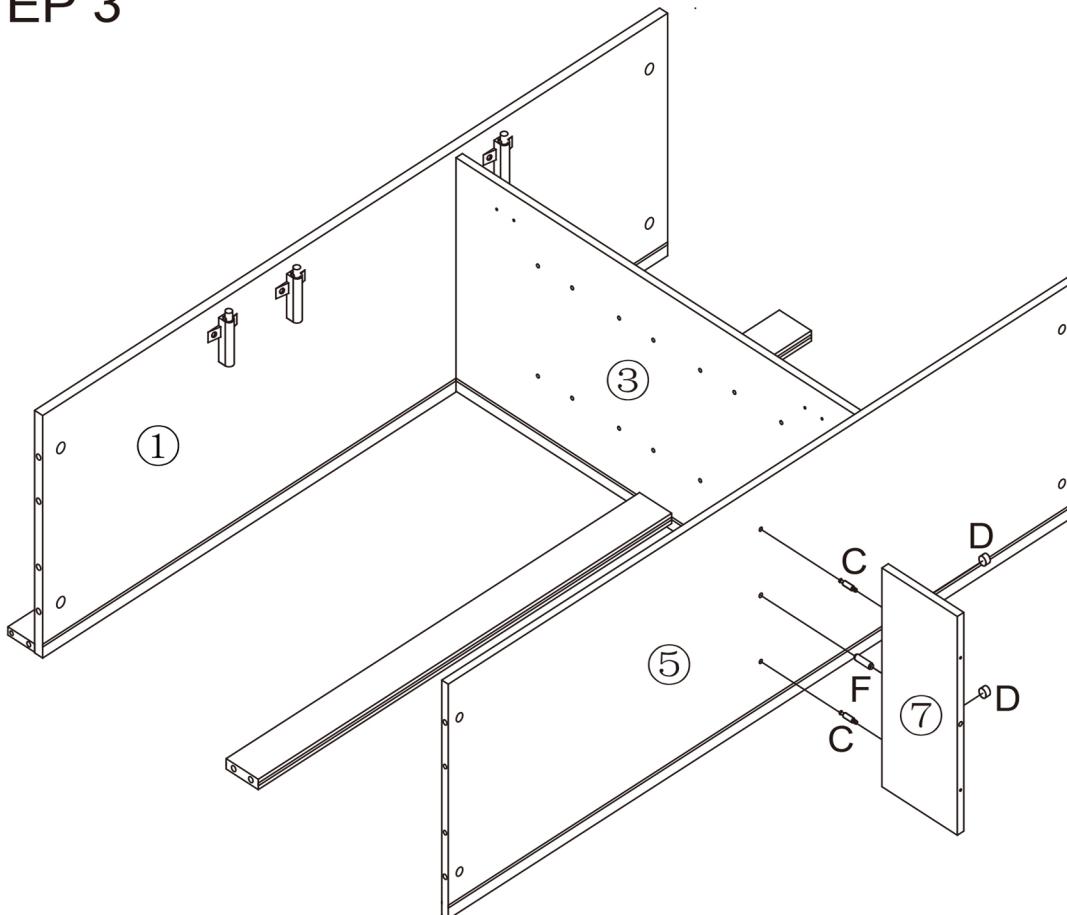



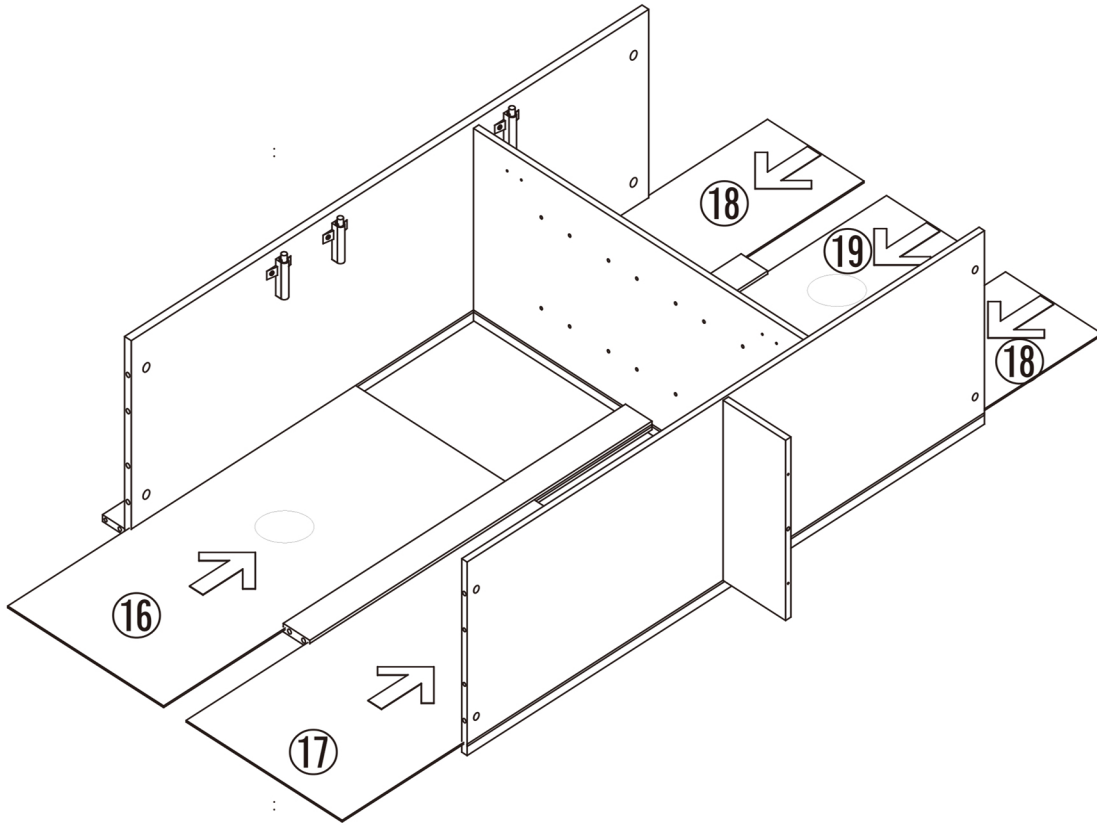

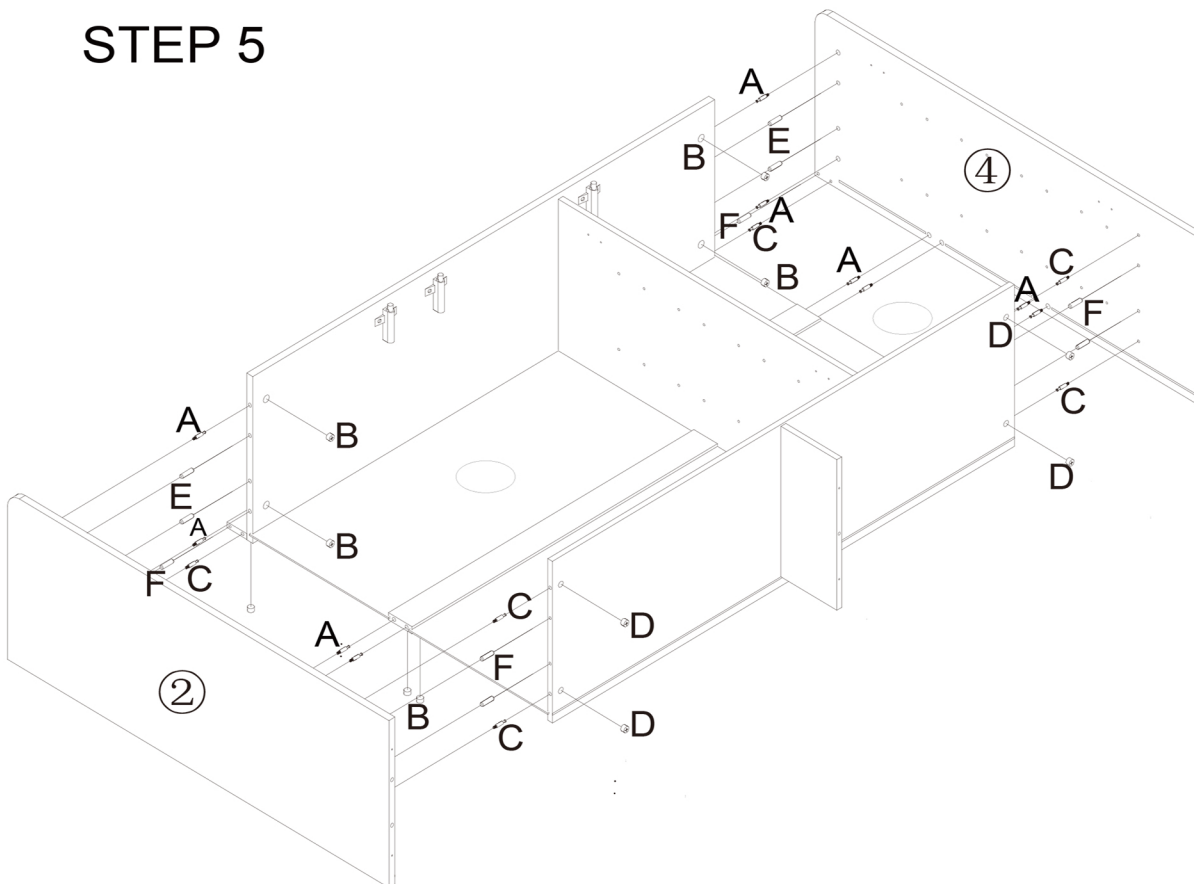

STEP 4



STEP 5

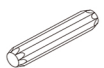

- A**  40mm
10PCS
- B**  15*12
10PCS
- C**  28mm
6PCS
- D**  12*10
6PCS
- E**  8*40
4PCS
- F**  6*30
6PCS

STEP 6

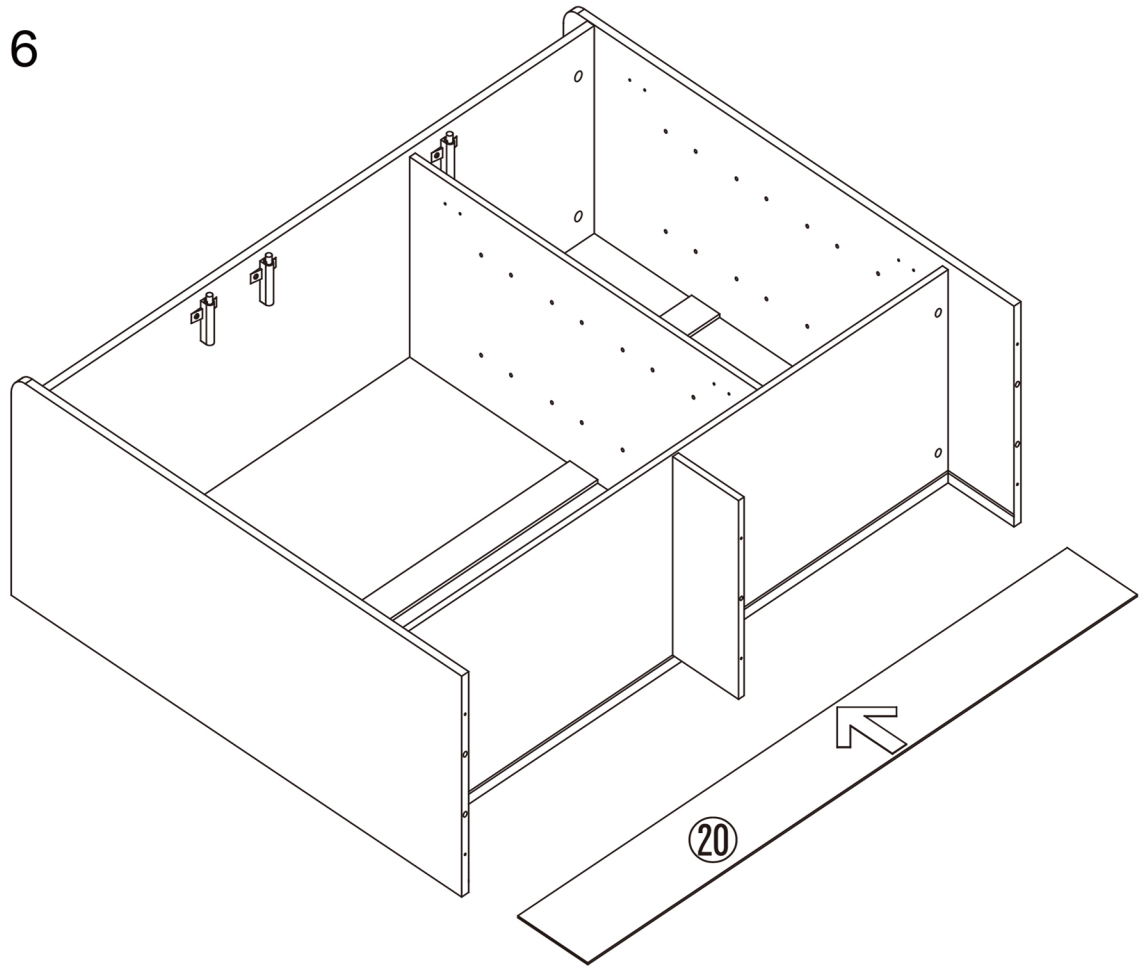

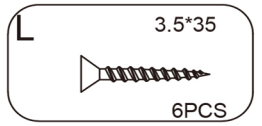
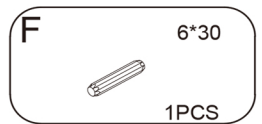
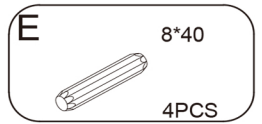
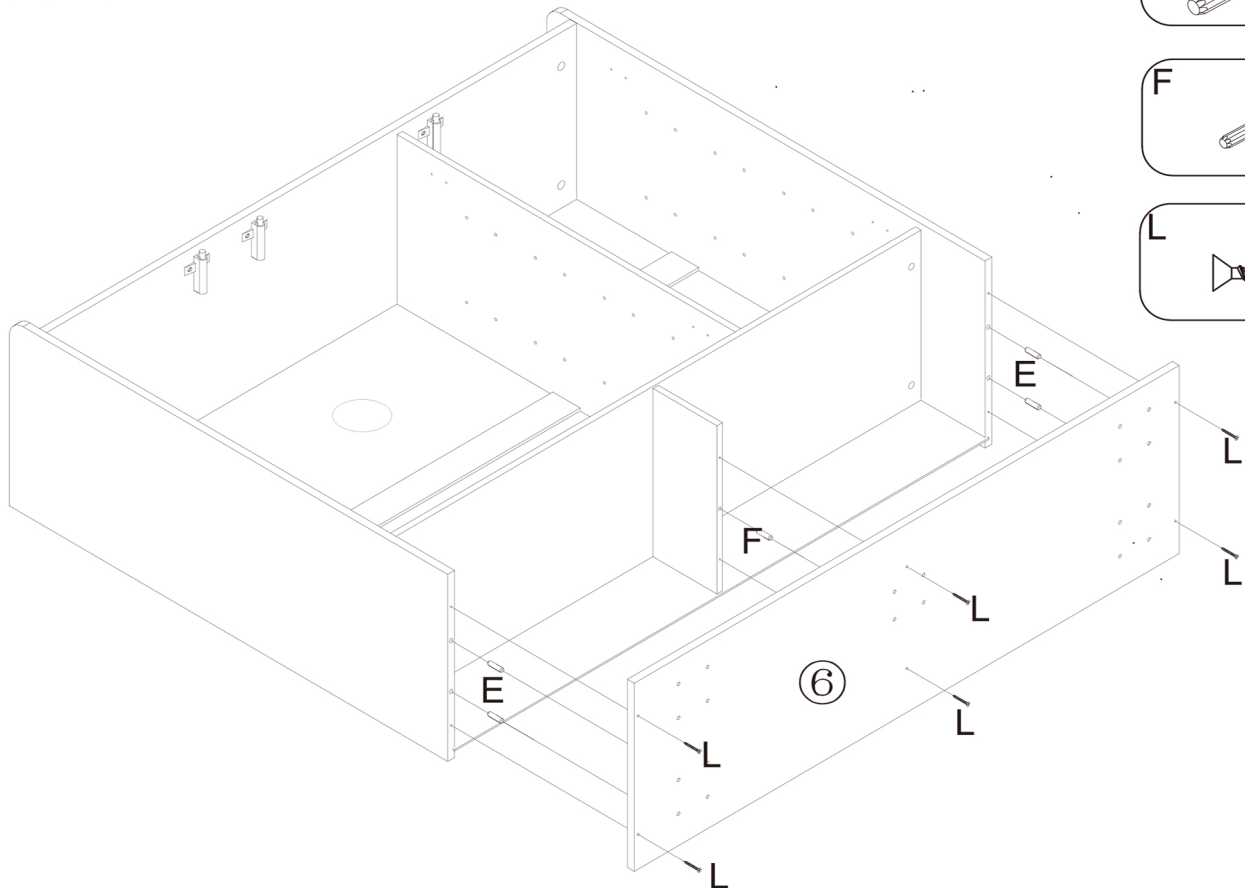

STEP 7



STEP 8

G 3.5*12

20PCS

P

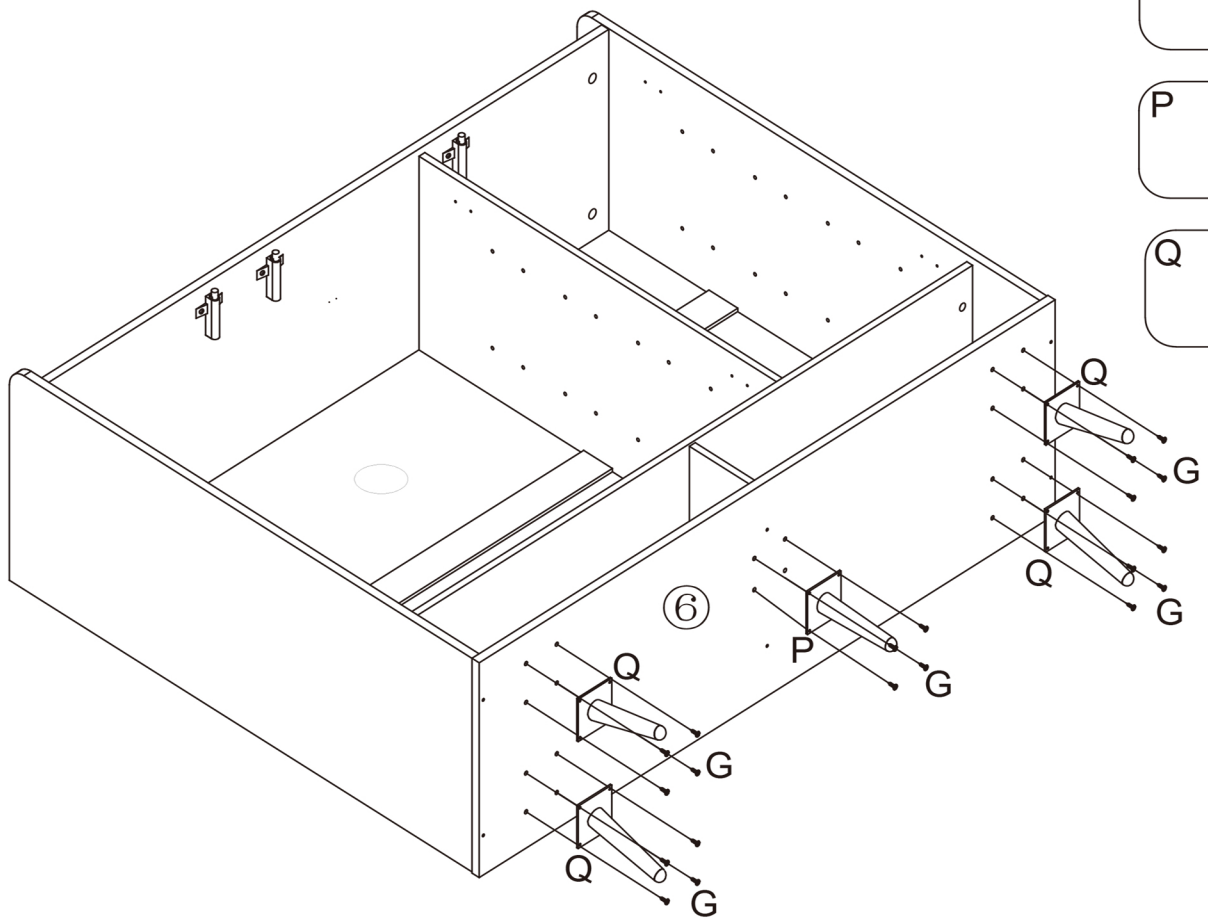
1PCS

Q

4PCS

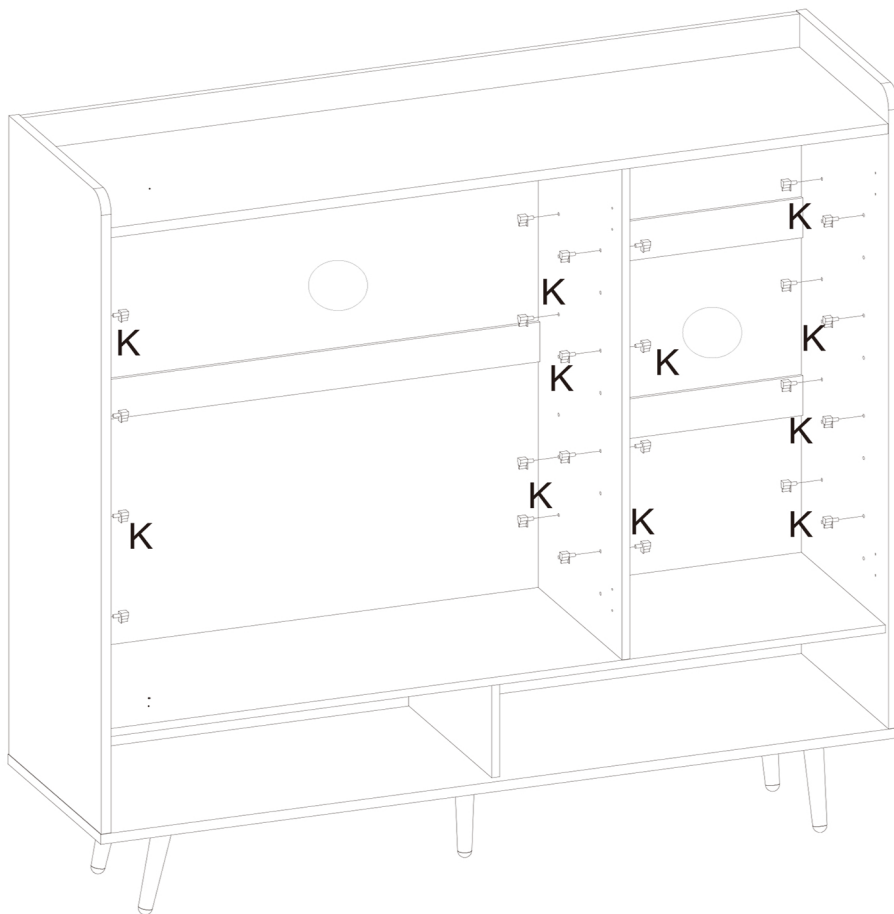

STEP 9

K

32PCS

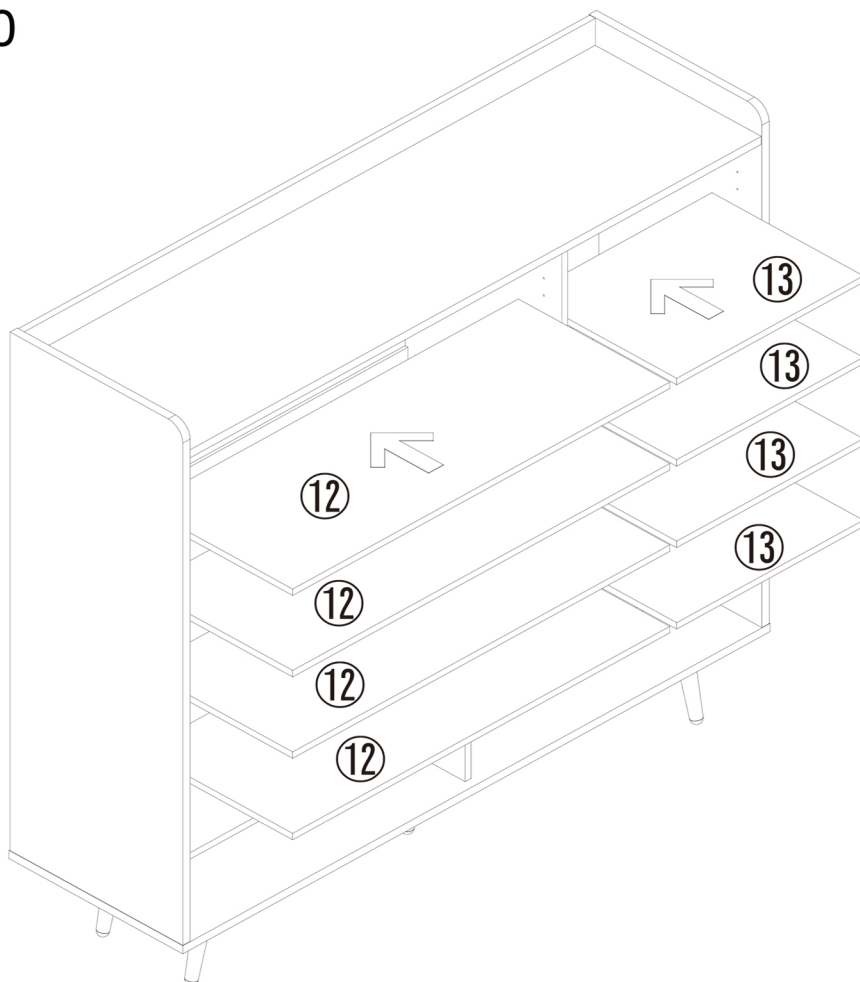

STEP 10

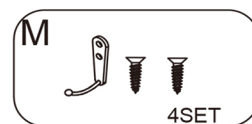
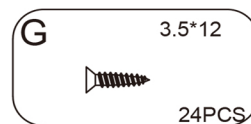
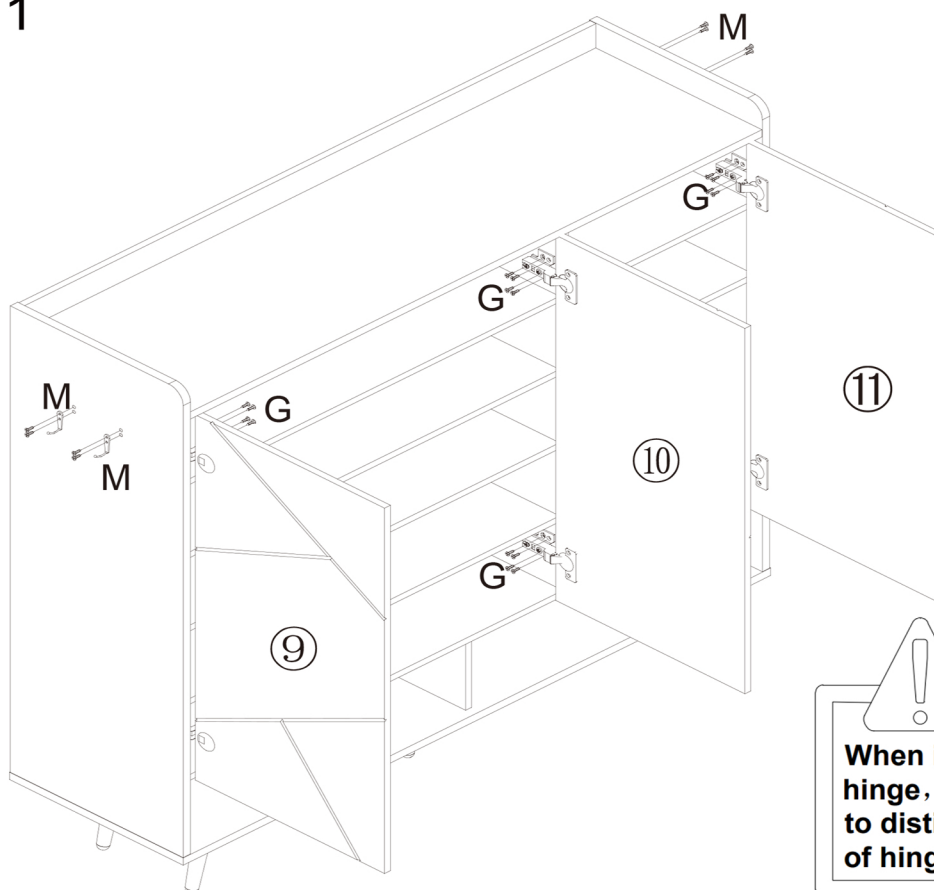

STEP 11



When installing hinge, please pay attention to distinguish the category of hinge!!!!

STEP 12

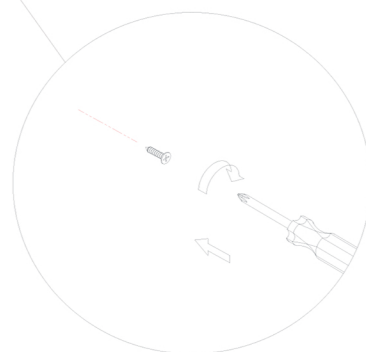
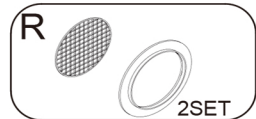
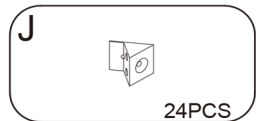
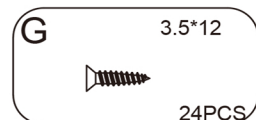
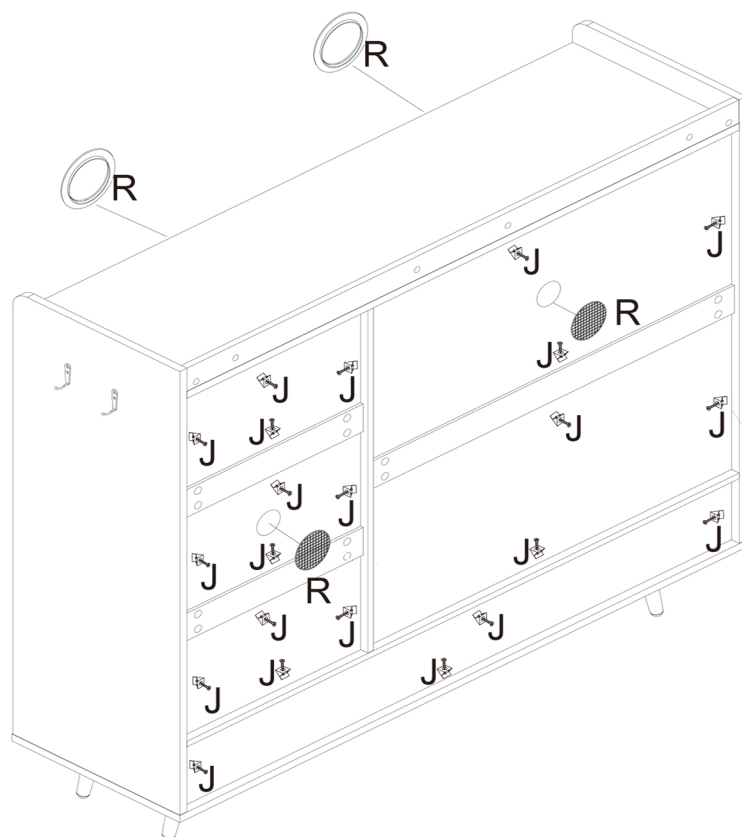

STEP 13

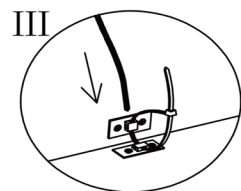
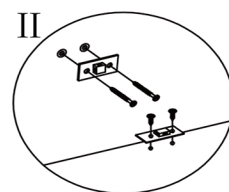
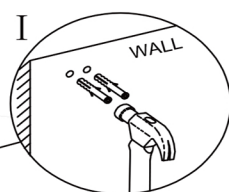
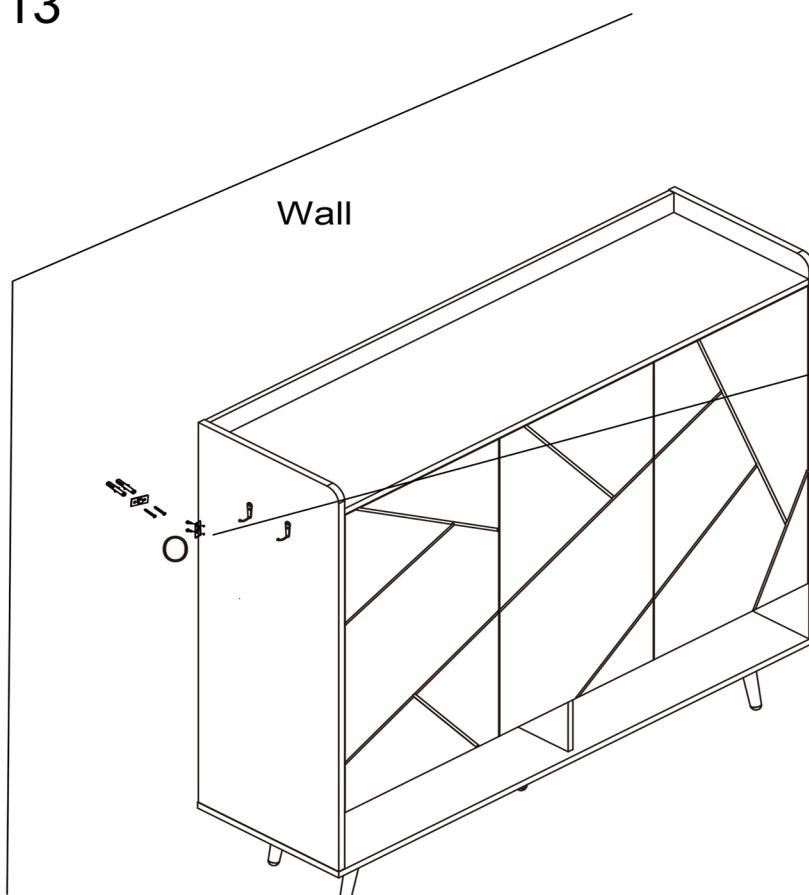

Adjusting the door

- Before adjusting the hinge, please check whether the cabinet is skewed.
- If the skew can not be repaired, please remove the anti-tipping device first, then adjust the cabinet to vertical position.
- Please adjust the hinge with the door open.
- Please operate it with more than 2 people, one person holds the door and the other one adjusts the screw.

Components Name

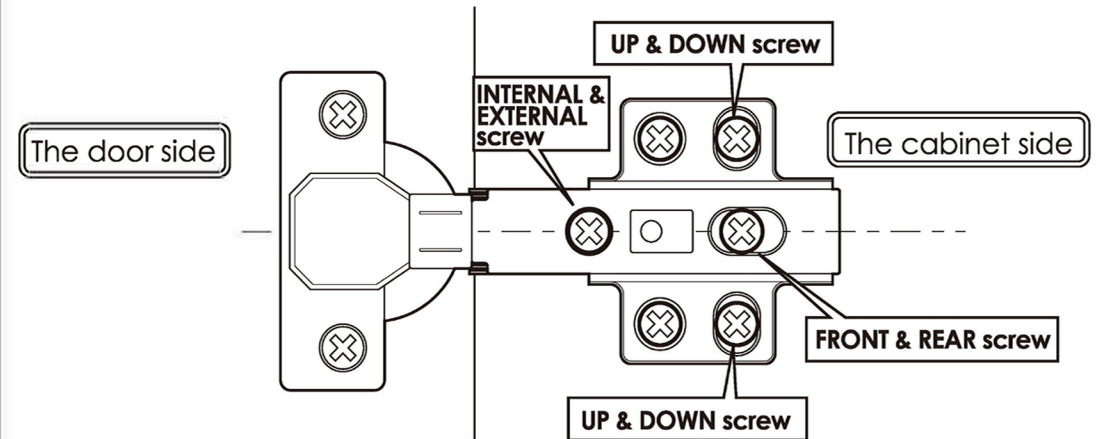

Obvious gaps between doors or Doors don't look closed

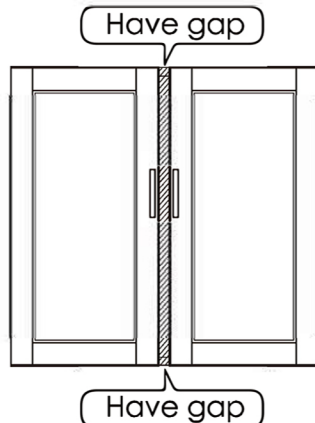

1 Turn "internal & external screw" to the right can make the door approach inside. Please adjust the doors little by little.

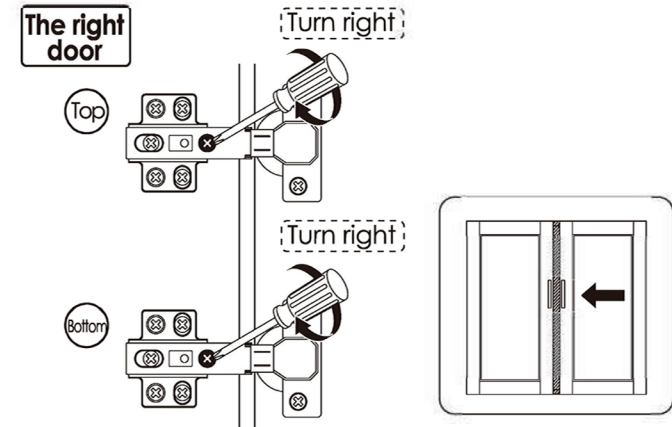
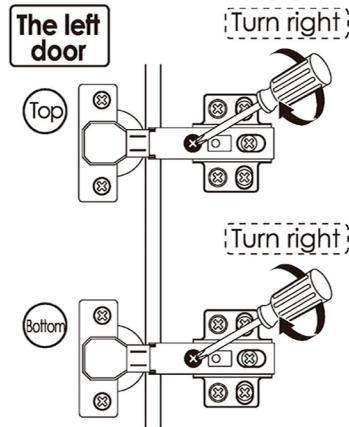

※ If the 2 doors are overlap, please turn the "internal & external screw" to the left.

When door is crooked



Please take the following steps to adjust first.

- 1 Rotate the "front and rear screws" to the left

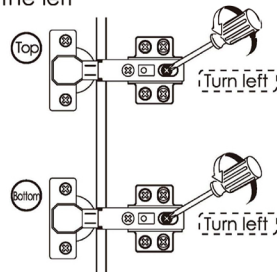

※ After adjusting the "front and rear screw", the door still does not change, please turn the "internal & external screw" to the right slightly.

- 2 Push the door to the cabinet

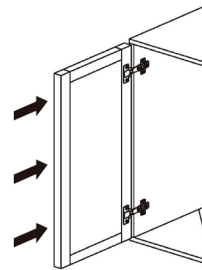

- 3 Rotate the "front and rear screws" to the right

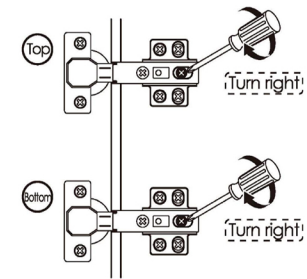

When door is leaning

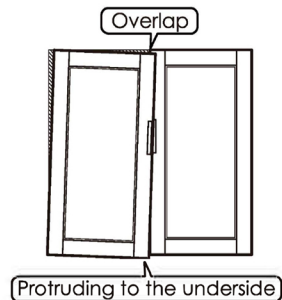

- 1 Turn "internal & external screw" to the left can make the top of the door tilted outward.

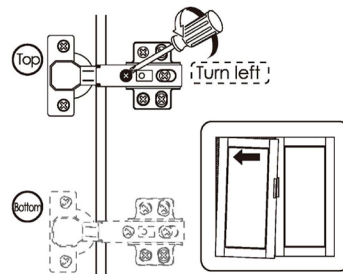

Protruding to the upside

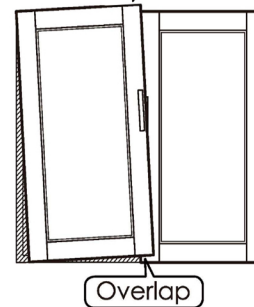

- 1 Turn "internal & external screw" to the left can make the bottom of the door tilted outward.

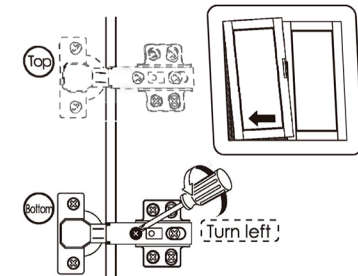

When the door is higher on top

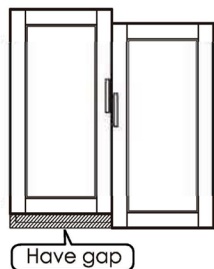

- 1 Turn "up & down screw" to the left

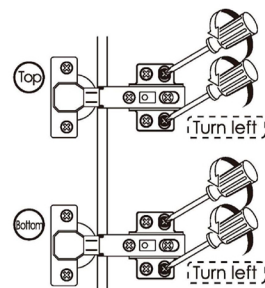

- 2 Lower the door's height so that 2 doors are of the same height.

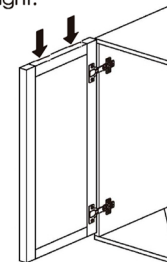

- 3 Turn "up & down screw" to the right

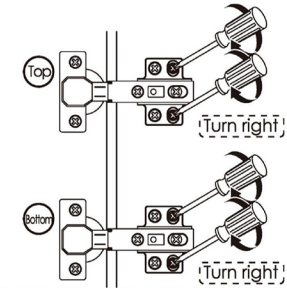

※ If the door is lower on bottom, please lift up the left door slightly on step 2