







ASSEMBLY INSTRUCTIONS & PARTS IDENTIFICATION COUNTER TABLE

Thank you for purchasing this quality product. Be sure to check all packing material carefully for small parts that may have come loose inside the carton during shipment .

Table Components			
No.	Code	Description	QTY
1		TABLE TOP LEG	1 PC
2		ASSEMBLY	2 PCS
3		STRETCHER	1 PC
4		LEVELER	4 PCS

Hardware Kit -			
No		Description	QTY
A		ALLEN BOLT M8X40 MM	10 PCS
B		ALLEN BOLT M6X30 MM	2 PCS
C		LOCK WASHER	12 PCS
D		FLAT WASHER 25 MM	10 PCS
E		FLAT WASHER 20 MM	2 PCS
F		ALLEN KEY 5 MM	1 PC
G		ALLEN KEY 4 MM	1 PC

STEP 1:

ATTACH STRETCHER TO THE LEG ASSEMBLY WITH SMALL BOLT (B), LOCK WASHER (C), AND FLAT WASHER (E). HAND TIGHTEN USING THE ALLEN WRENCH (G).

STEP 2:

PLACE THE TABLETOP ON A CLEAN PADDED SURFACE TO PREVENT SCRATCHES. ATTACH THE BASE UNIT TO THE TABLETOP WITH THE LONG BOLT (A), LOCK WASHER (C) AND FLAT WASHER (D). HAND TIGHTEN USING THE ALLEN WRENCH (F).

STEP 1

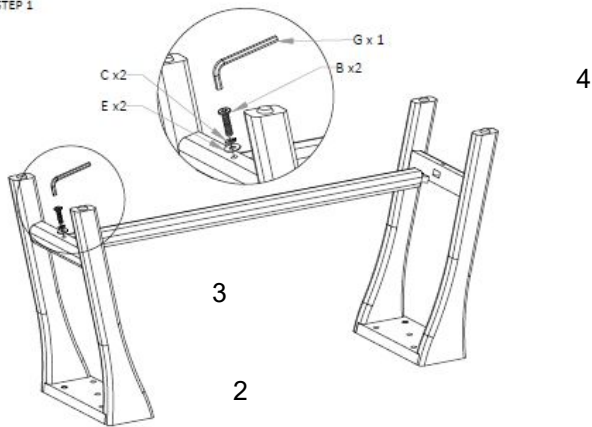

STEP 2

