

PARTY TENT

6X9 M
20X30 FT

SKU:EPT2369G020-1
EPT2369G020-2
EPT2369G020-3
EPT2369G020-4

ASSEMBLY INSTRUCTIONS

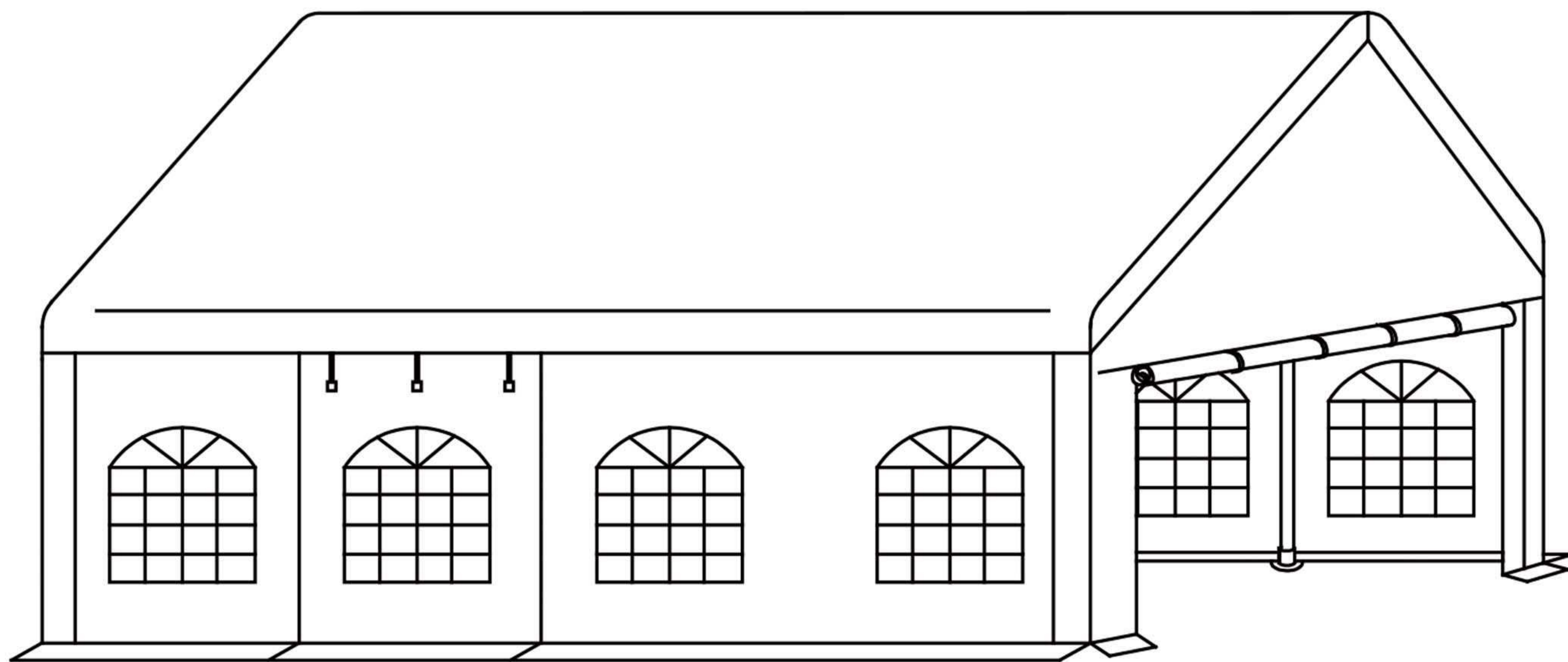

Please check the number of parts in the following accessory catalogue when unpacking. We have sent you more small parts for spare. If there is any missing or any questions about the installation. Please feel free to contact us. We will reply within 24 hours.



E-mail: cs.helper01@gmail.com

TOOLS RECOMMENDED

*NOTE: The recommended tools are not included in boxes and need to be prepared by yourself.

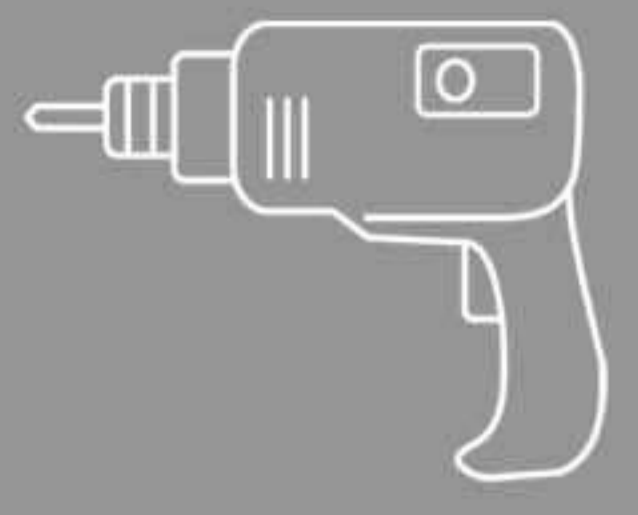

DRILL



RUBBER Mallet



STEPLADDER
(6.5Ft Or More)



SAFETY HAT



GLOVES



SAFETY GOGGLES

ATTENTIONS



Since it is easy to lose many small accessories during the installation, please collect all the screw accessories before the assembly is completed



To better align the screws for practical situations, do not fully tighten screws initially



Please reinforced the Gazebo and do not use in heavy winds or inclement weather



Make sure all screws are tightened before use and check all screws, buckles and straps every 90 days



Two or more people are required for assembly



Please clear the snow off the roof in time for the heavy snowfall and do not use it

Please take care of the screws and contact the after-sales service if there is any problem with the installation or parts.



ACCESSORY CATALOGUE

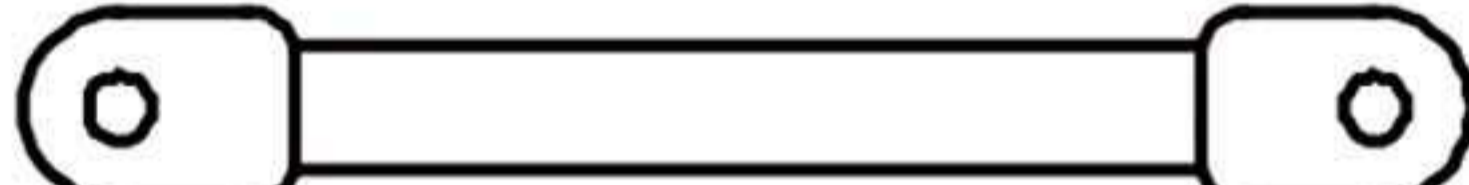
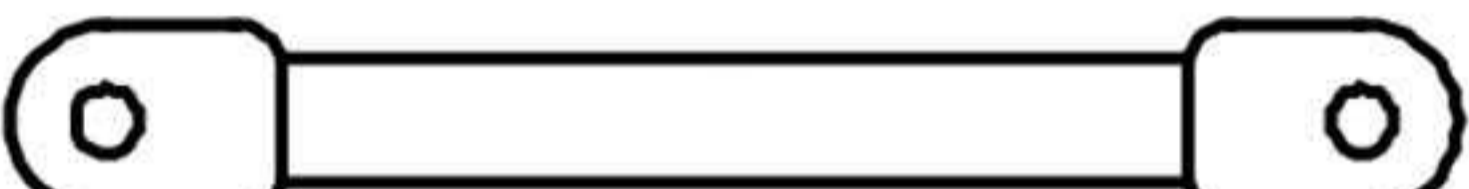

BOX 1

SKU:EPT2369G020-1

Item no.	Reference Image	Qty.	Item no.	Reference Image	Qty.
2		12	4		8
7		8			

BOX 2

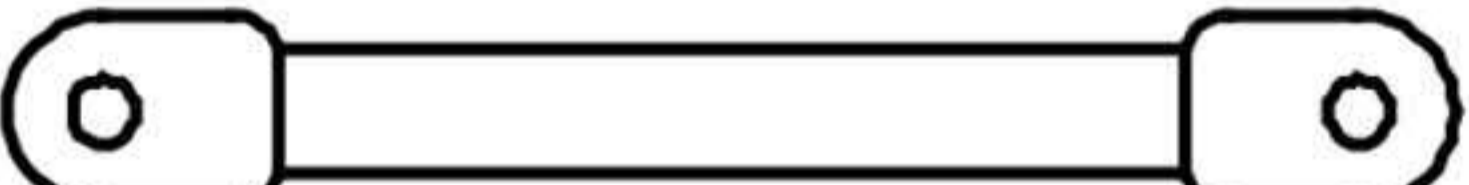
SKU:EPT2369G020-2

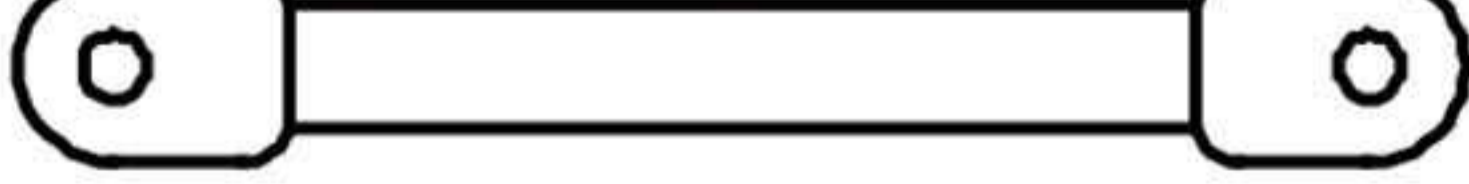
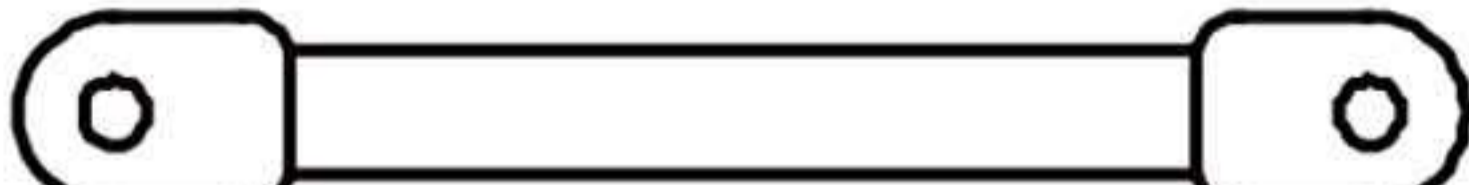
Item no.	Reference Image	Qty.	Item no.	Reference Image	Qty.
1		20	6		5
3		10	8		4
5		10			









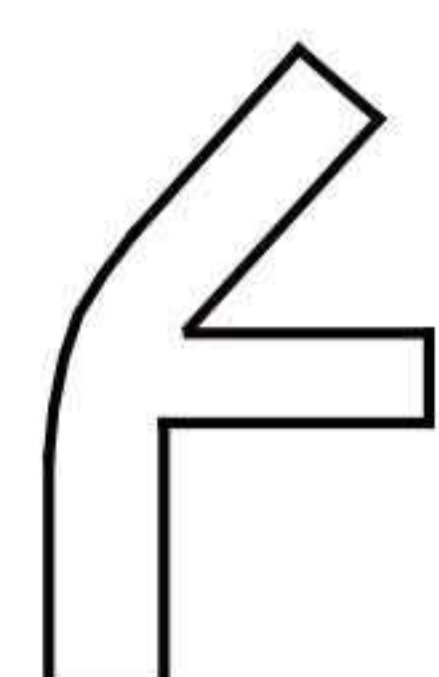

Please take care of the screws and contact the after-sales service if there is any problem with the installation or parts.

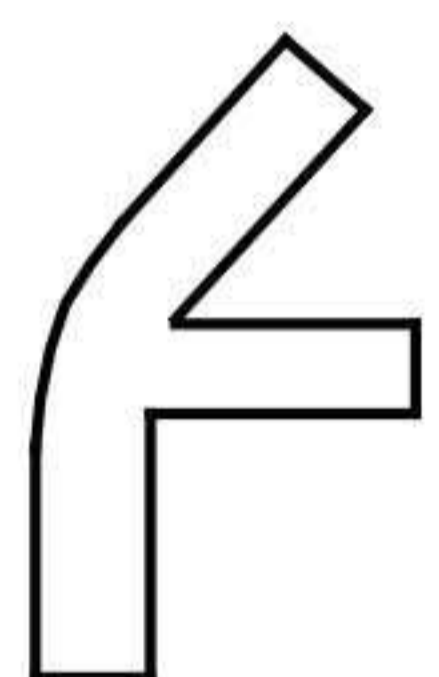
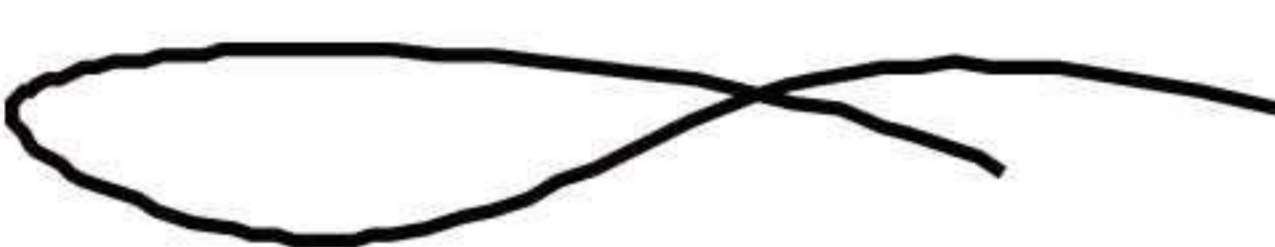
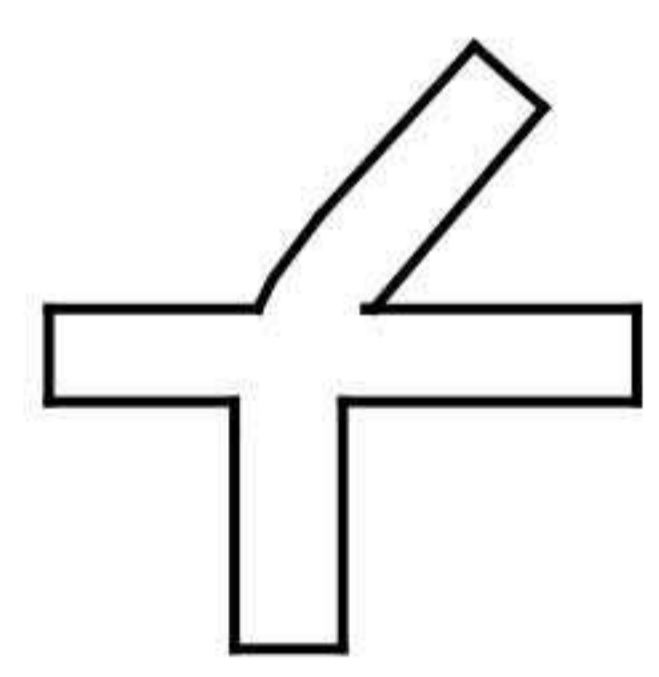
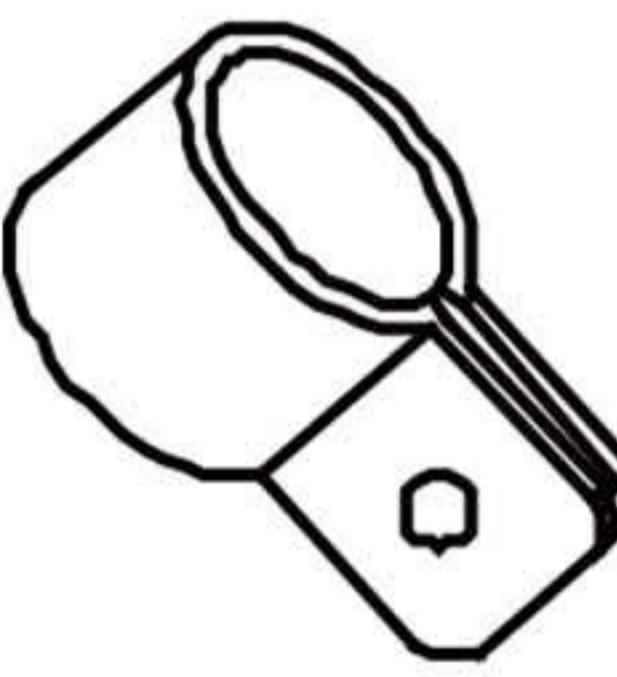
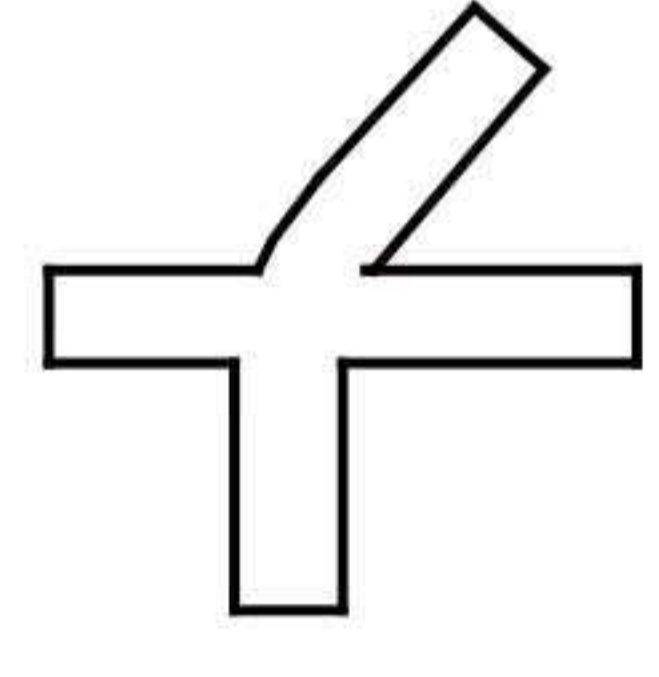
➔ ✉ E-mail: cs.helper01@gmail.com

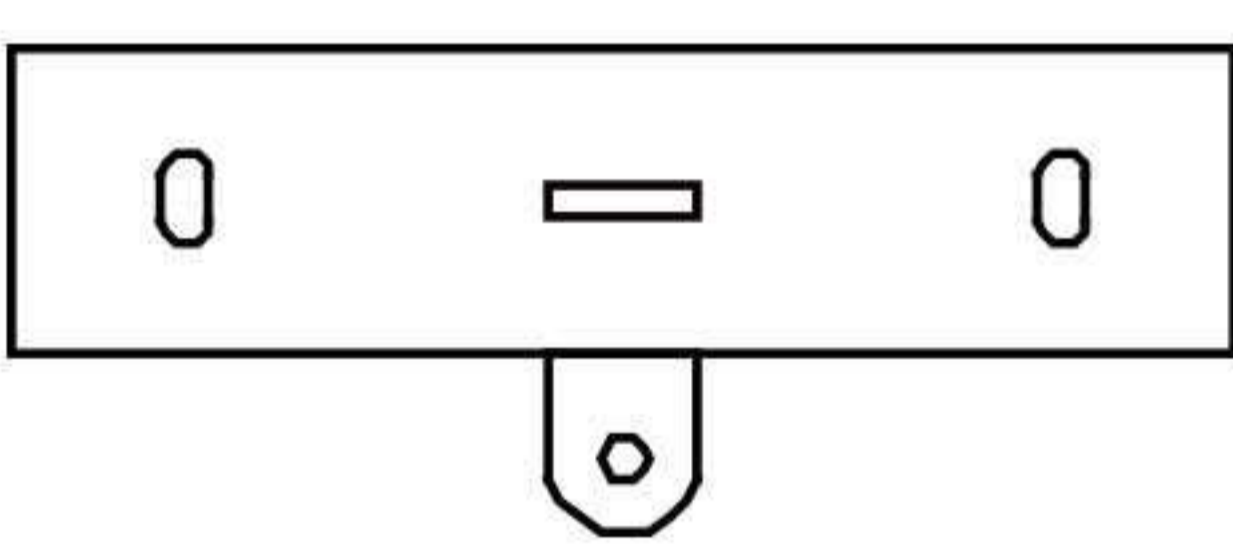
ACCESSORY CATALOGUE

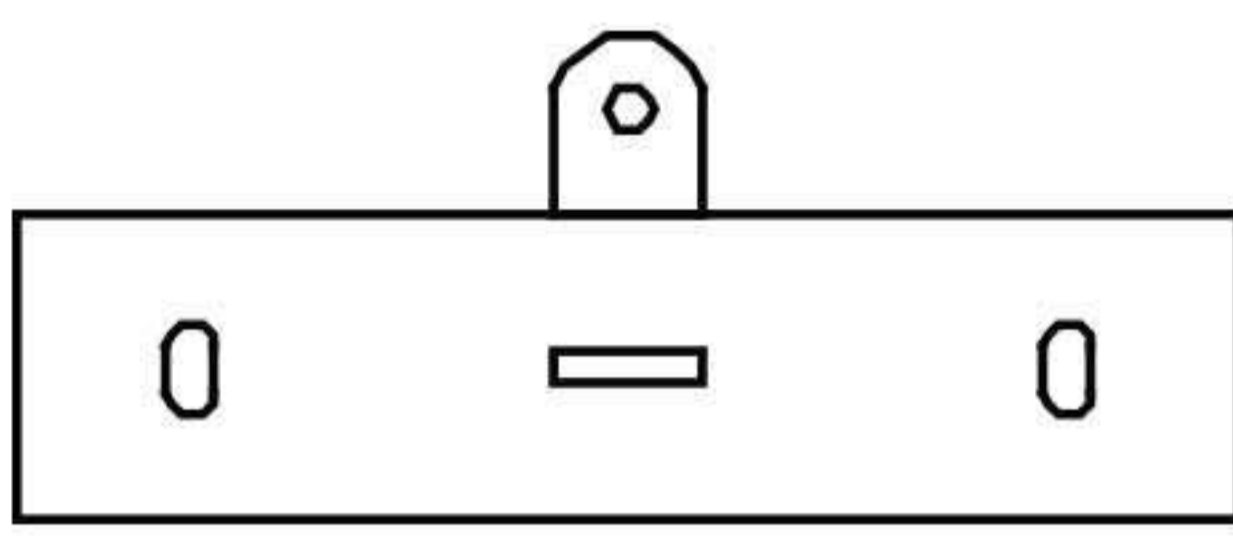
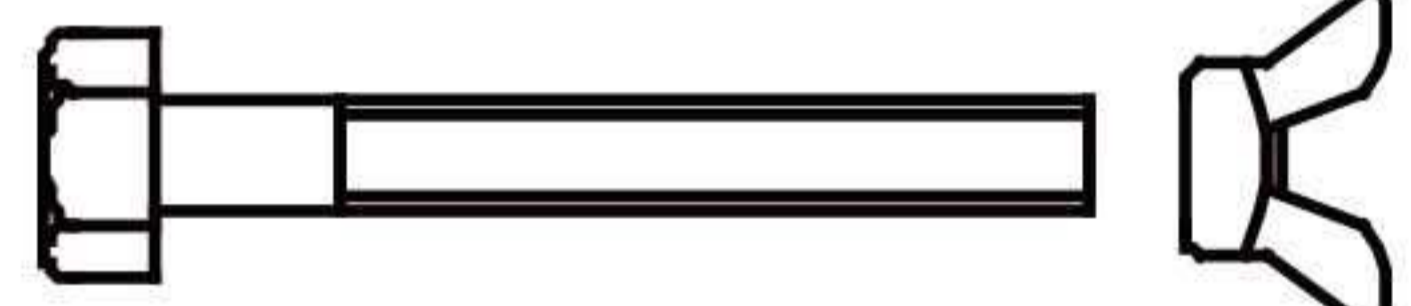
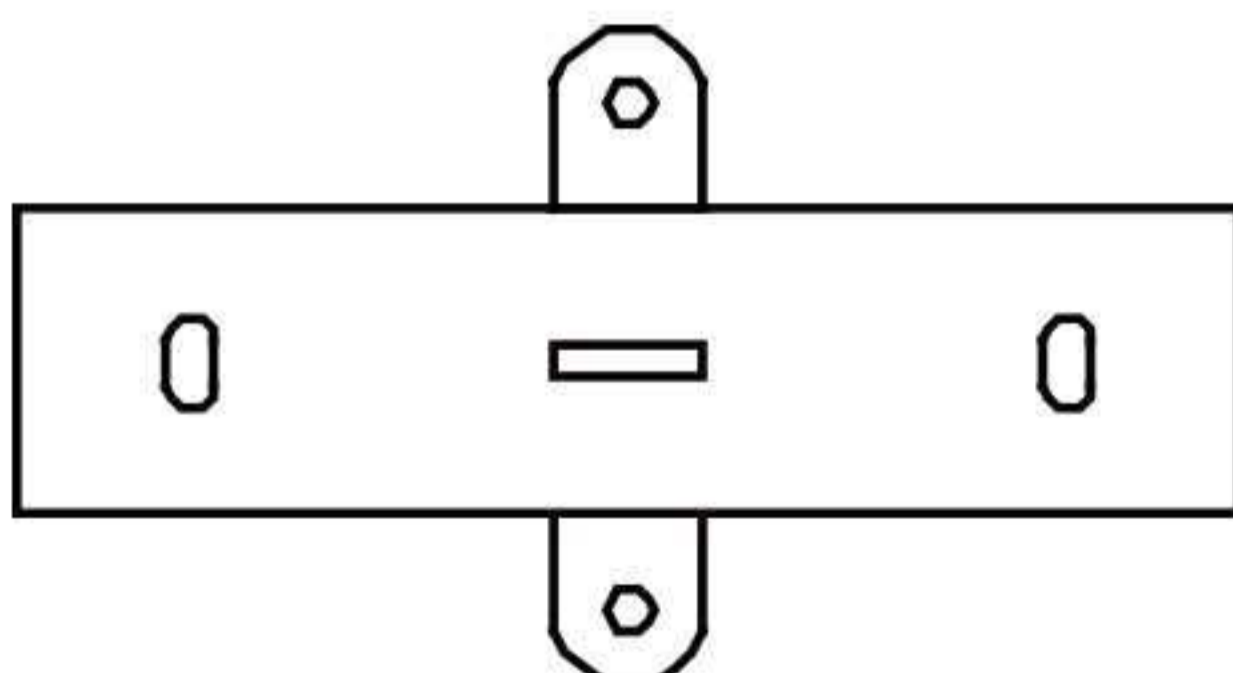
BOX 3

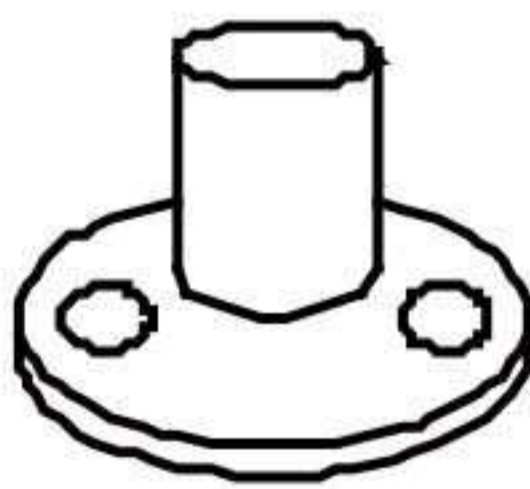
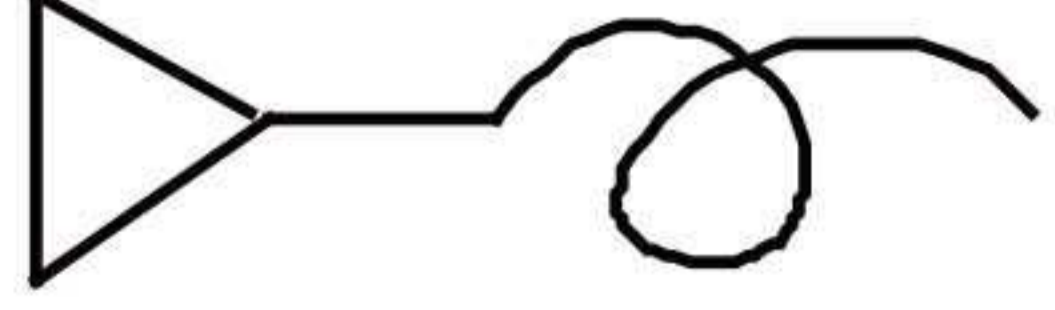
SKU:EPT2369G020-3

Item no.	Reference Image	Qty.	Item no.	Reference Image	Qty.
A		2	G		112
A1		4	H		4
B		3	I		8
B1		6	J	 M6x25	8
C1		2	K	 M6x16	36
C		2	L	 M8x55	10
D		6	M	 M8x50	20
F		10	N	 ø4*150mm	18
O		4			

Please take care of the screws and contact the after-sales service if there is any problem with the installation or parts.



ACCESSORY CATALOGUE

BOX 4

SKU:EPT2369G020-4

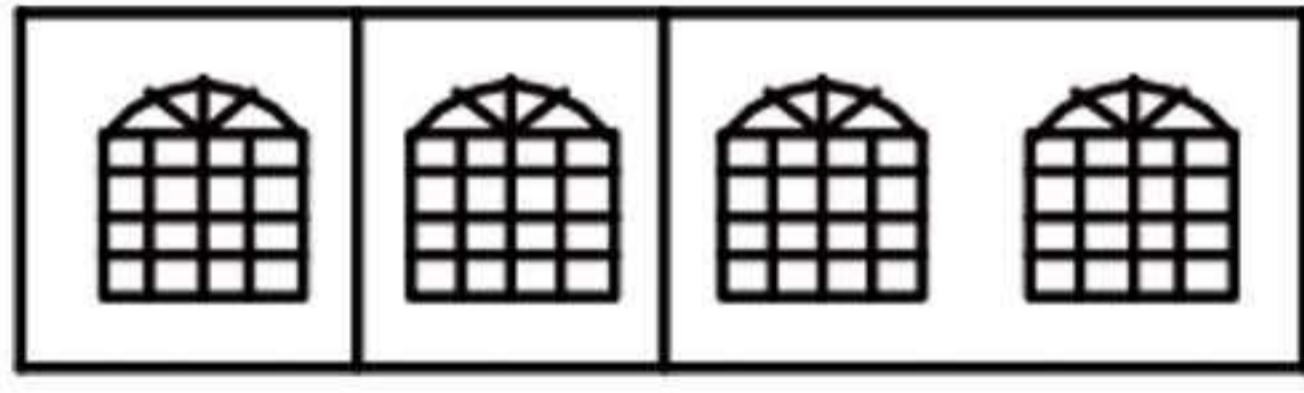
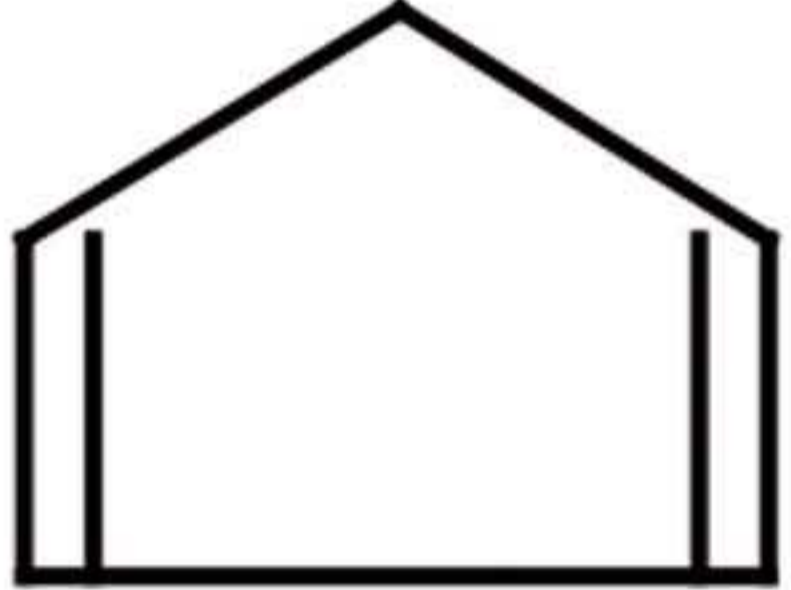
Item no.	Reference Image	Qty.	Item no.	Reference Image	Qty.
P		1	SANDBAG		4
Q		2	E		2

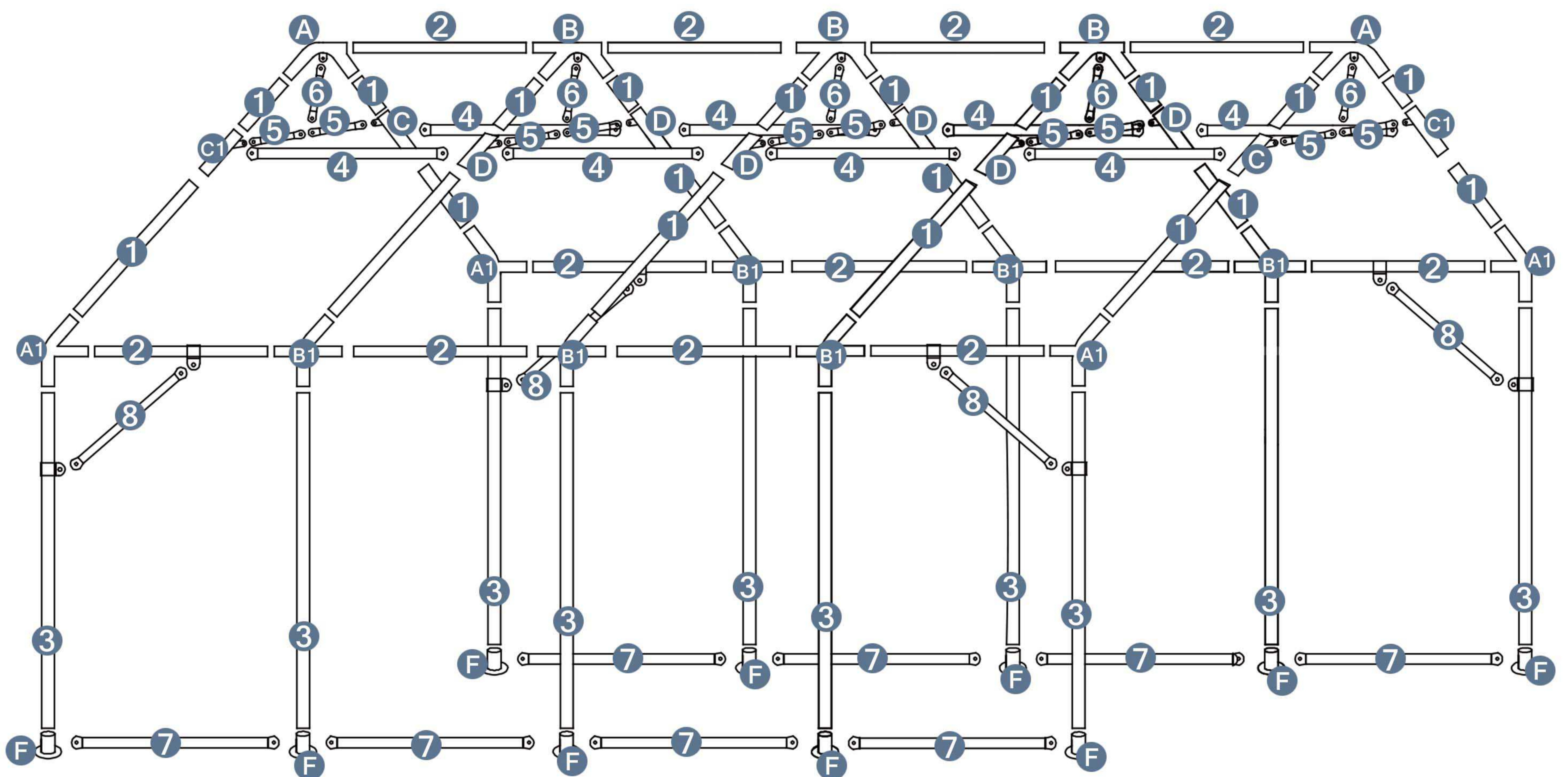







P1-1

Please take care of the screws and contact the after-sales service if there is any problem with the installation or parts.

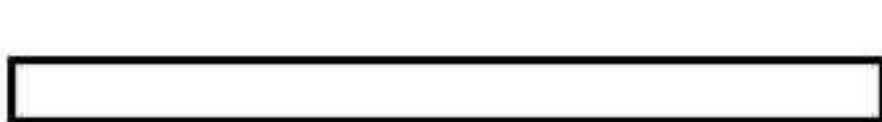
➔ ✉ E-mail: cs.helper01@gmail.com

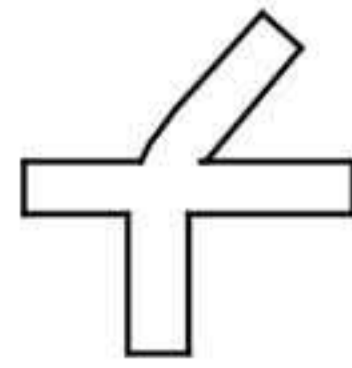
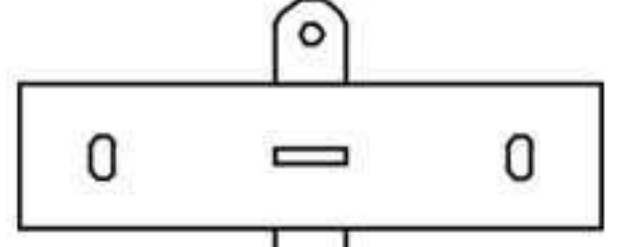
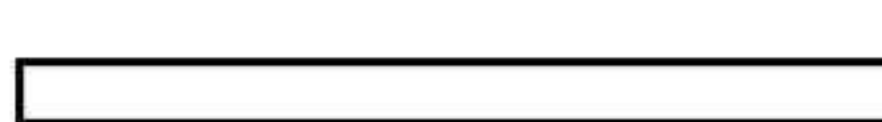
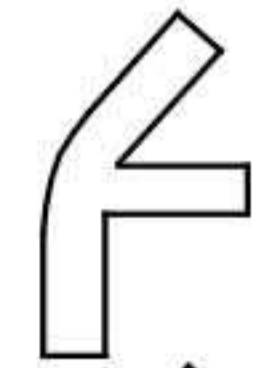
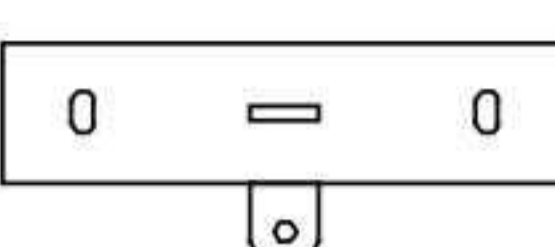
STEP 1

Parts required

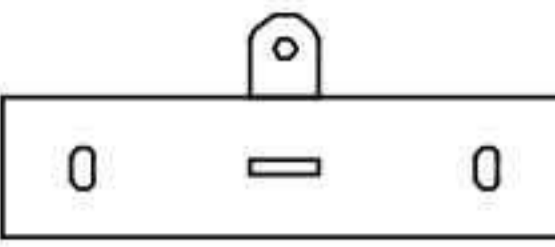
- | | | | | | | | |
|---|----------------|---|----------------|---|----------------|---|---------------|
|  | 1 20pcs |  | A 2pcs |  | B1 6pcs |  | D 6pcs |
|  | 2 12pcs |  | A1 4pcs |  | C1 2pcs |  | I 4pcs |
|  | 4 8pcs |  | B 3pcs |  | C 2pcs | | |

For convenience, please place each accessory according to the position shown in the figure, and then start to build.

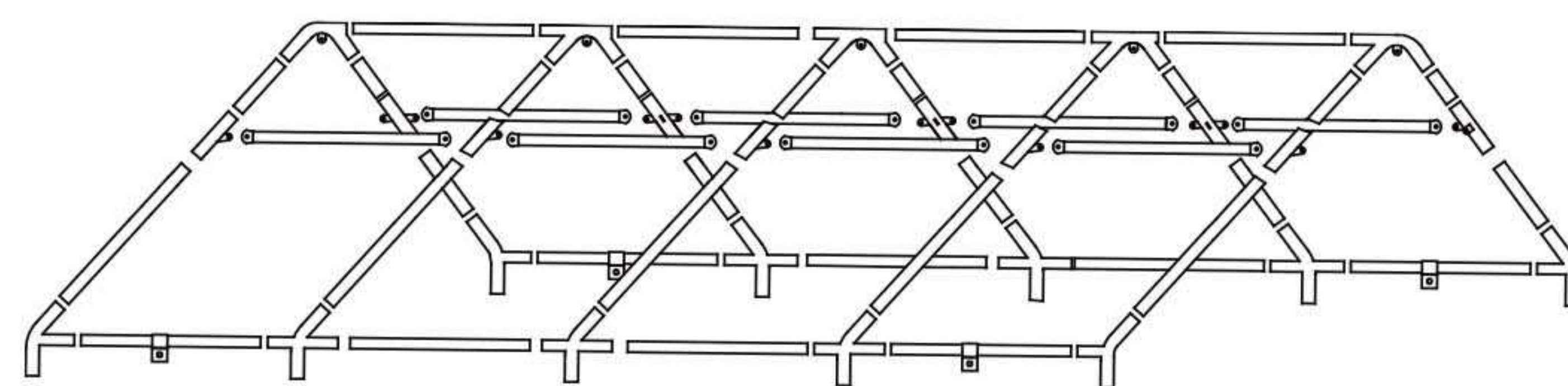
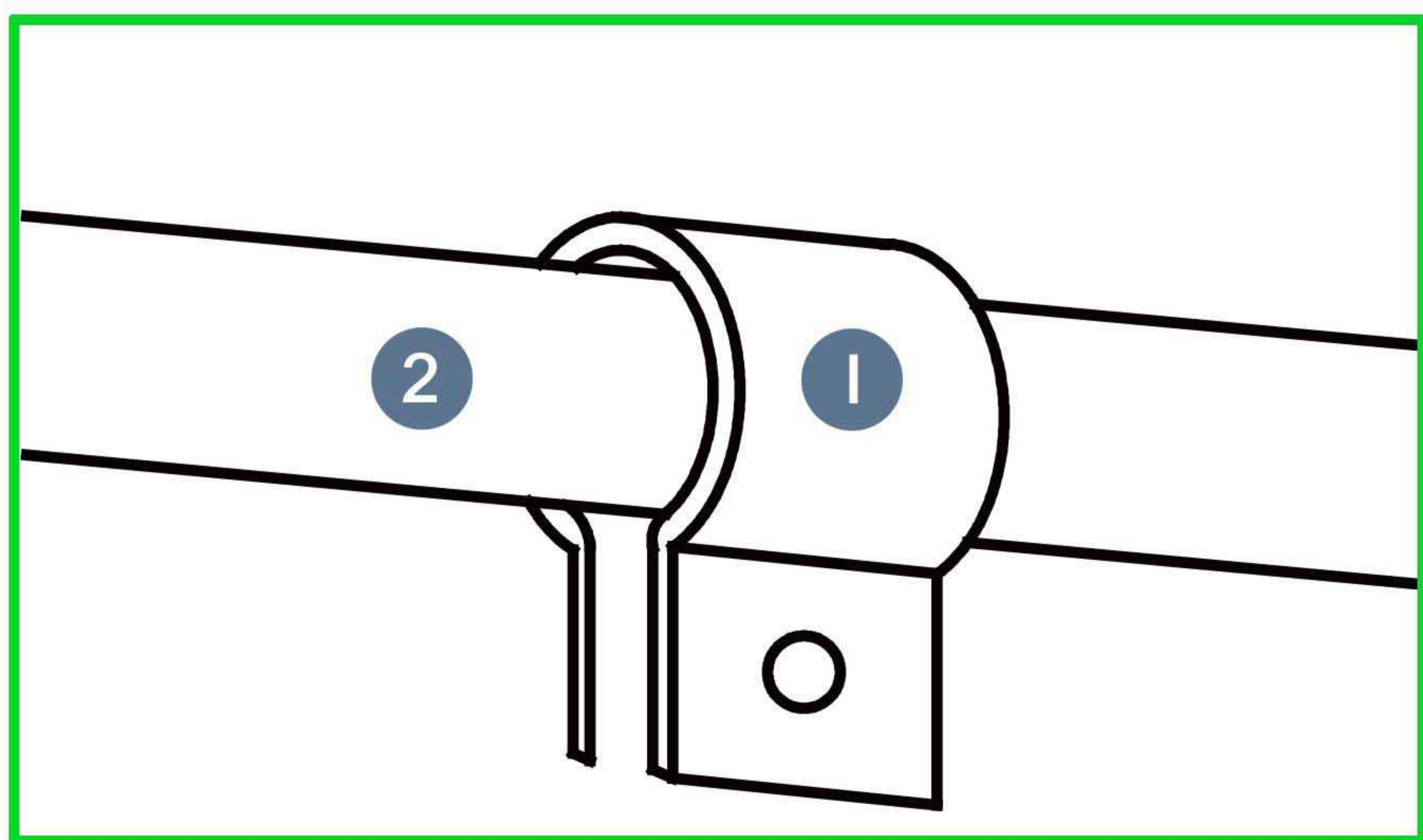
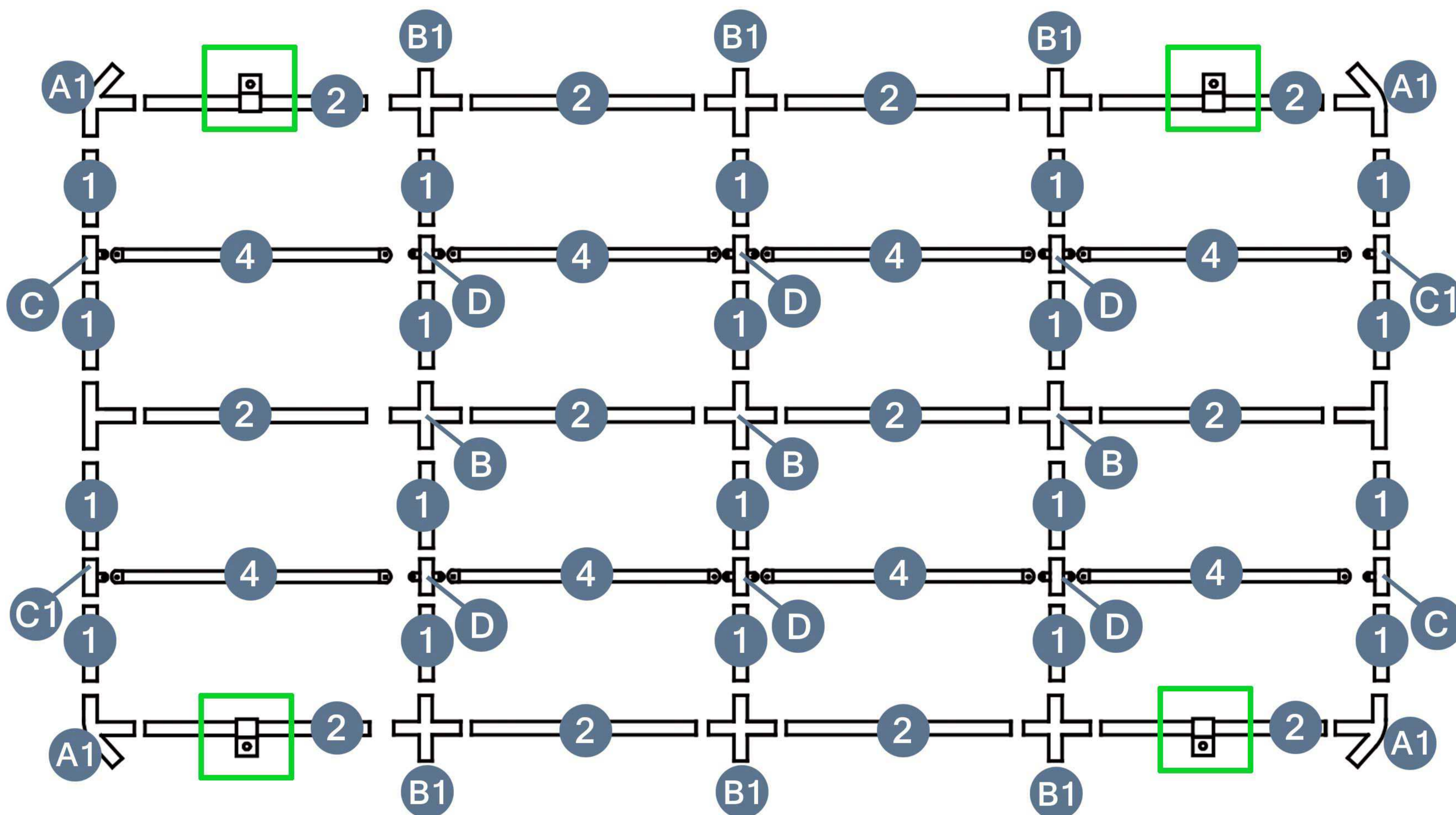

What it looks like after it is set up

Please take care of the screws and contact the after-sales service if there is any problem with the installation or parts.



STEP 2

Parts required



K 16pcs



M 20pcs

Note that  and  are different screws.

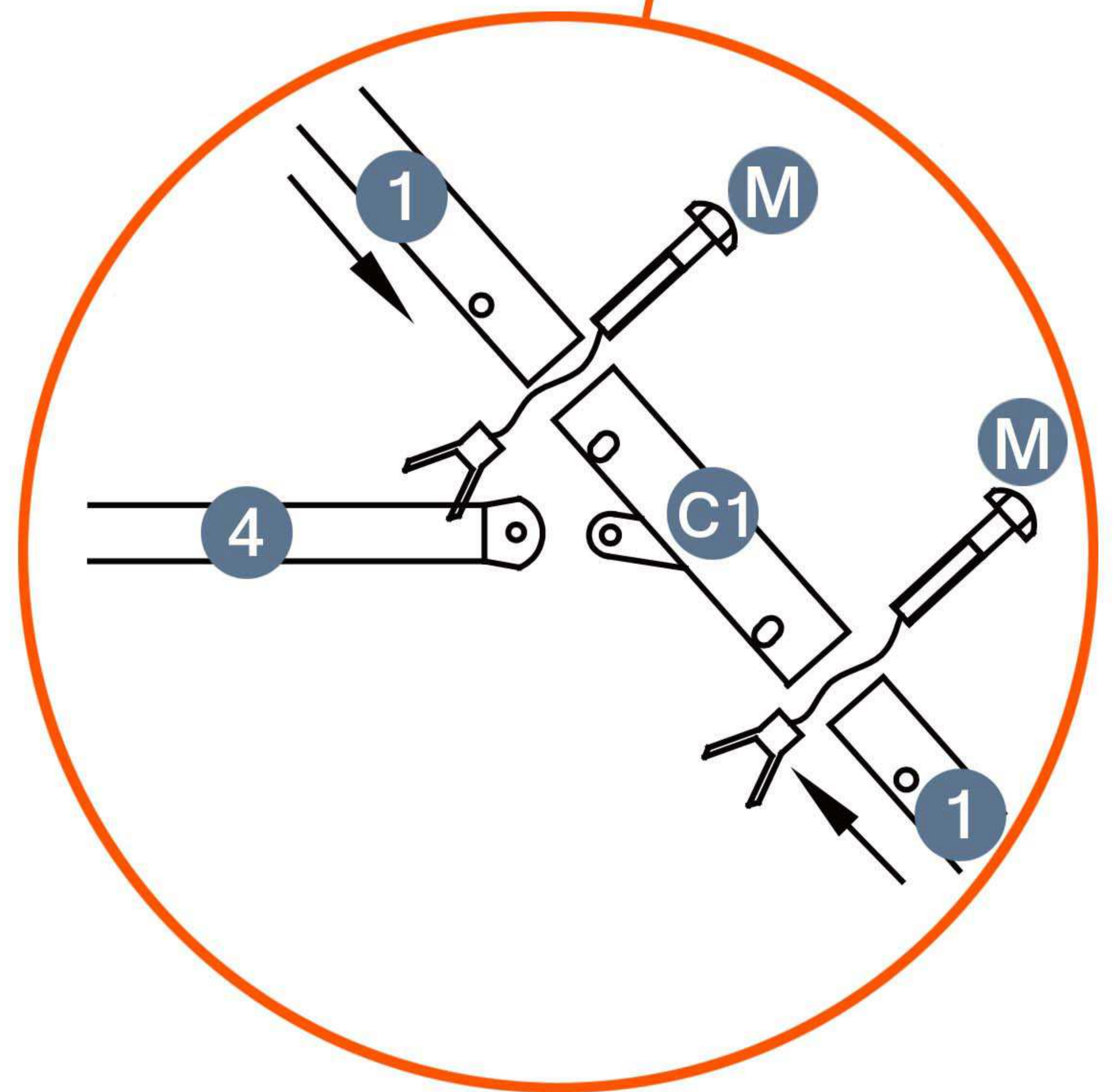
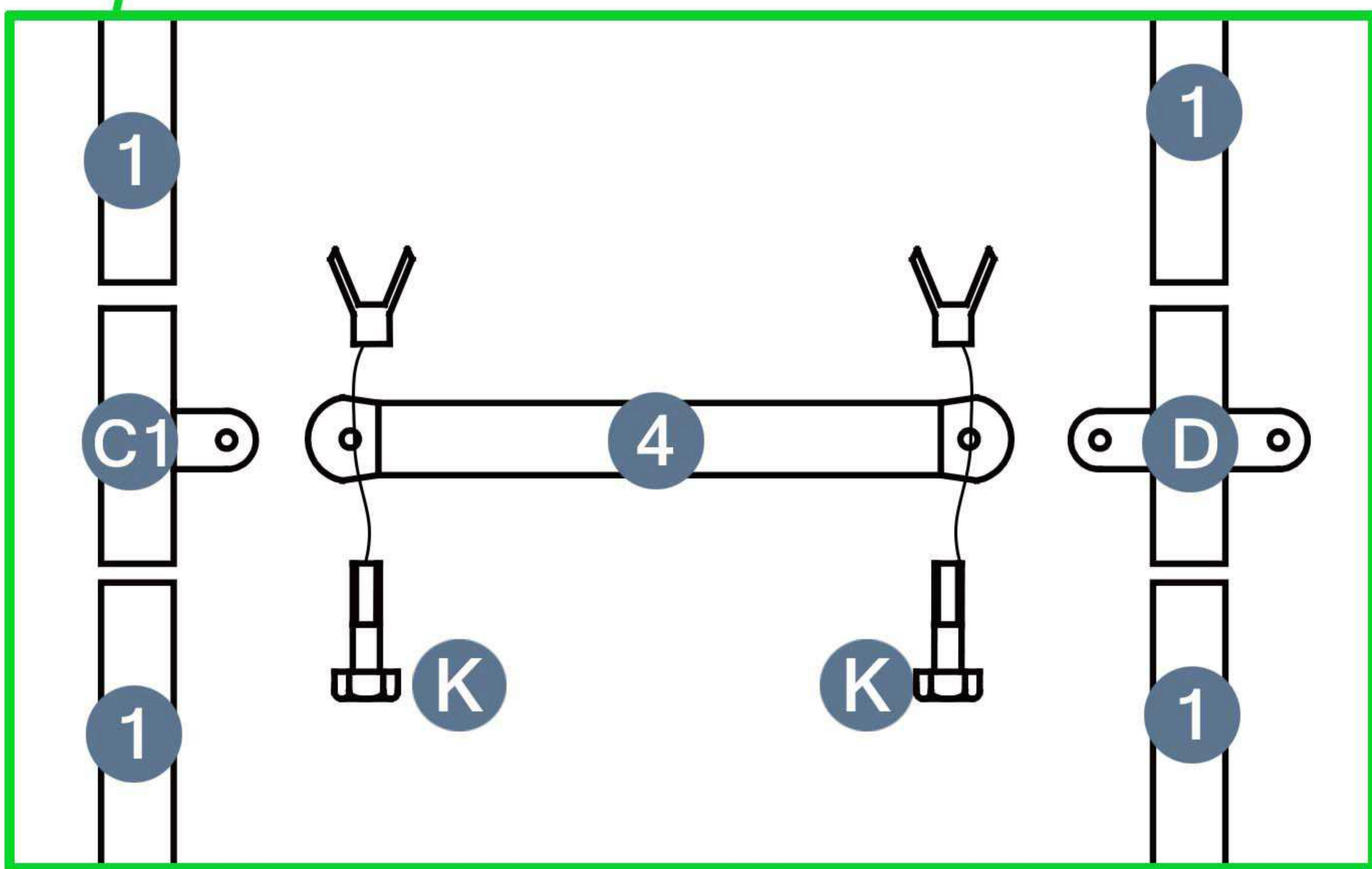
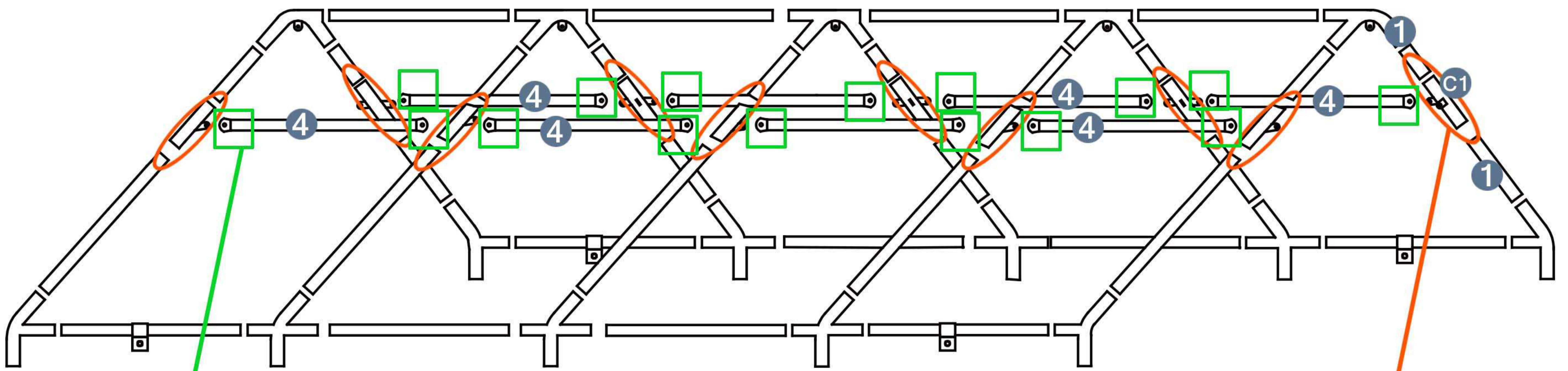



Please take care of the screws and contact the after-sales service if there is any problem with the installation or parts.

  E-mail: cs.helper01@gmail.com

STEP 3

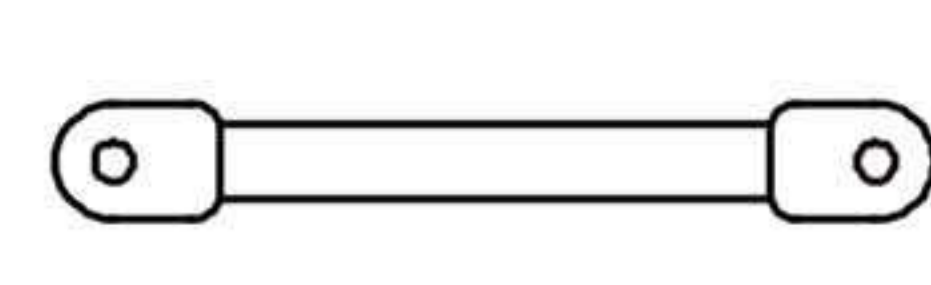
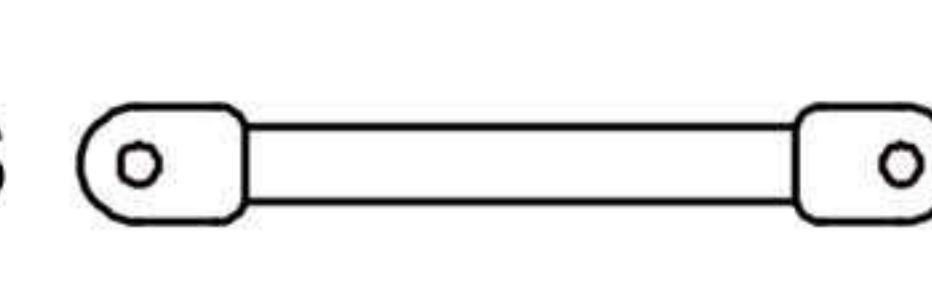
Parts required

 **5** 10pcs  **6** 5pcs  **K** 20pcs

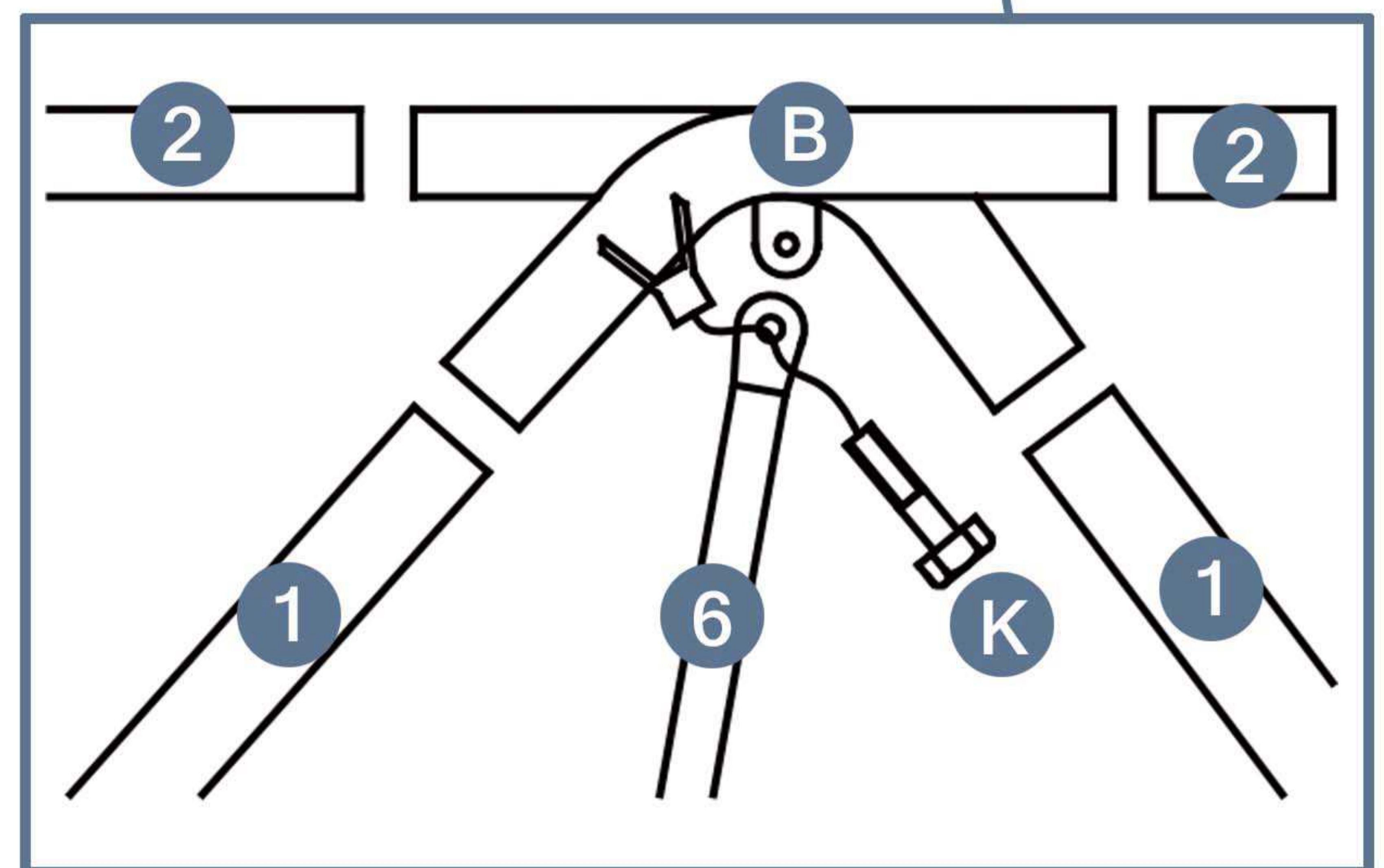
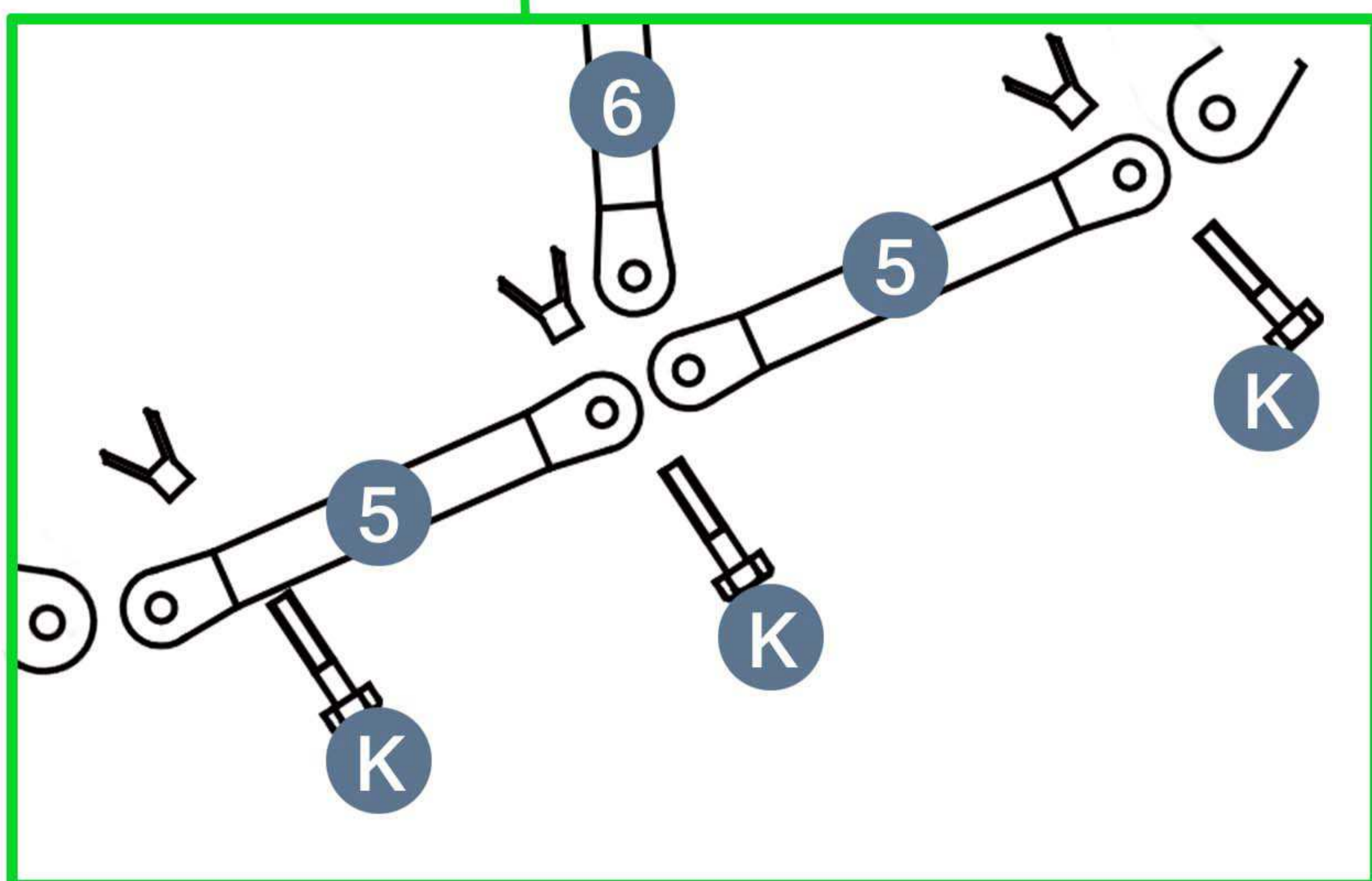
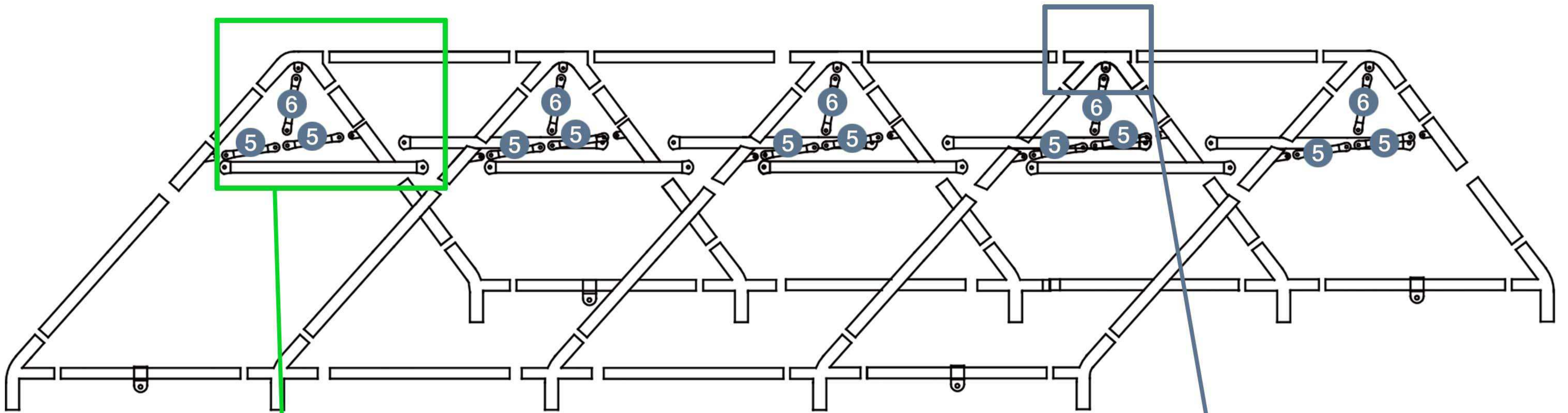

Please take care of the screws and contact the after-sales service if there is any problem with the installation or parts.

STEP 4

Parts required

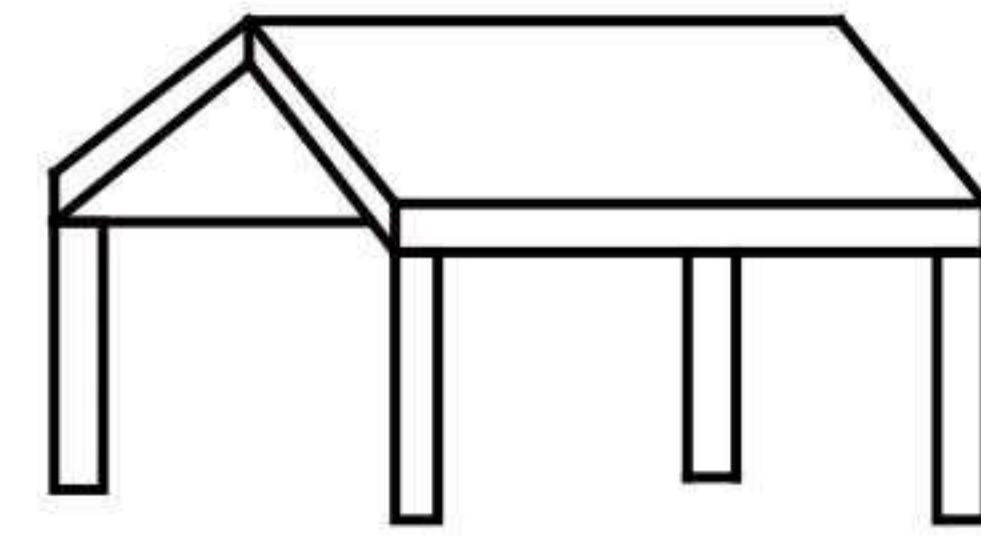

P 1pcs

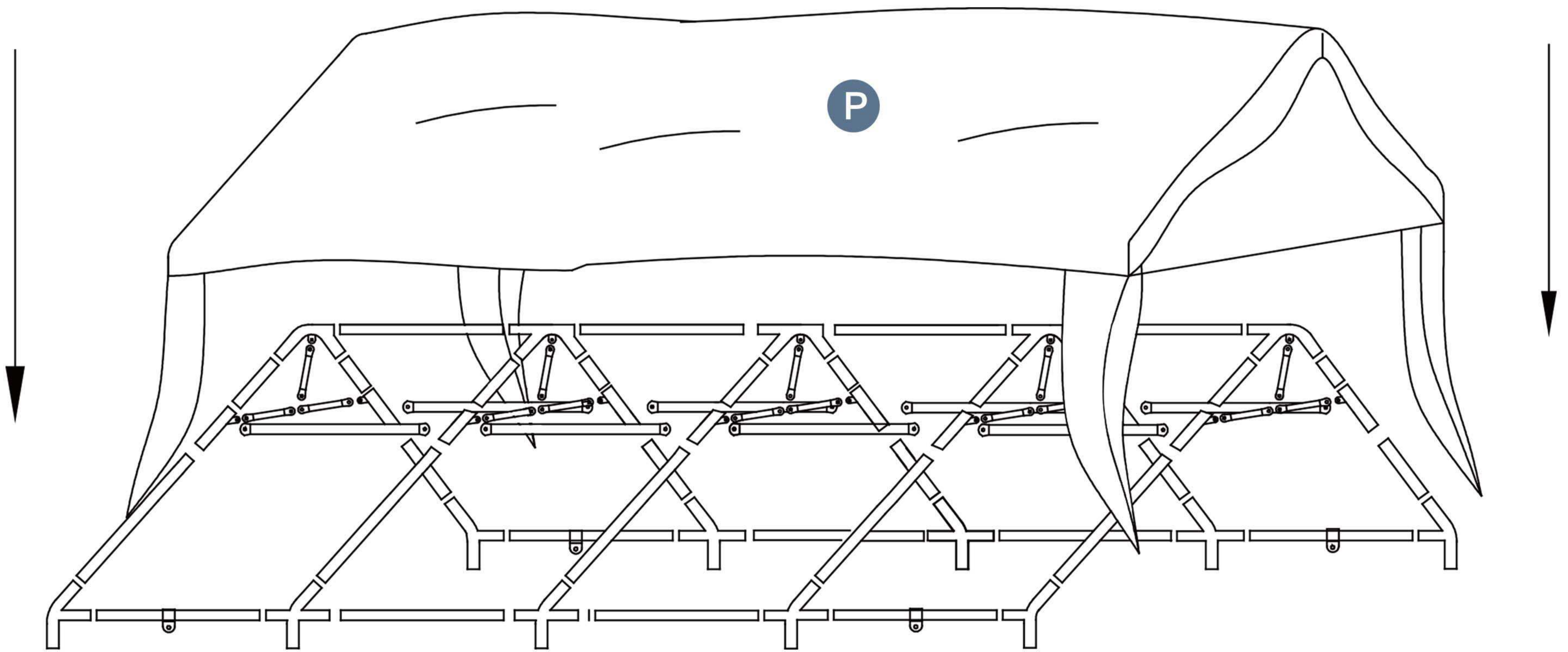

Please take care of the screws and contact the after-sales service if there is any problem with the installation or parts.

➔ ✉ E-mail: cs.helper01@gmail.com

STEP 5

Parts required

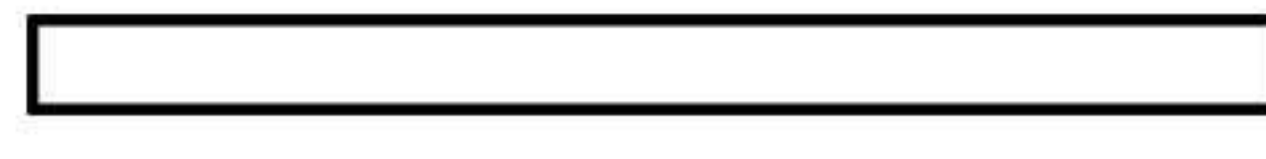

3 10pcs

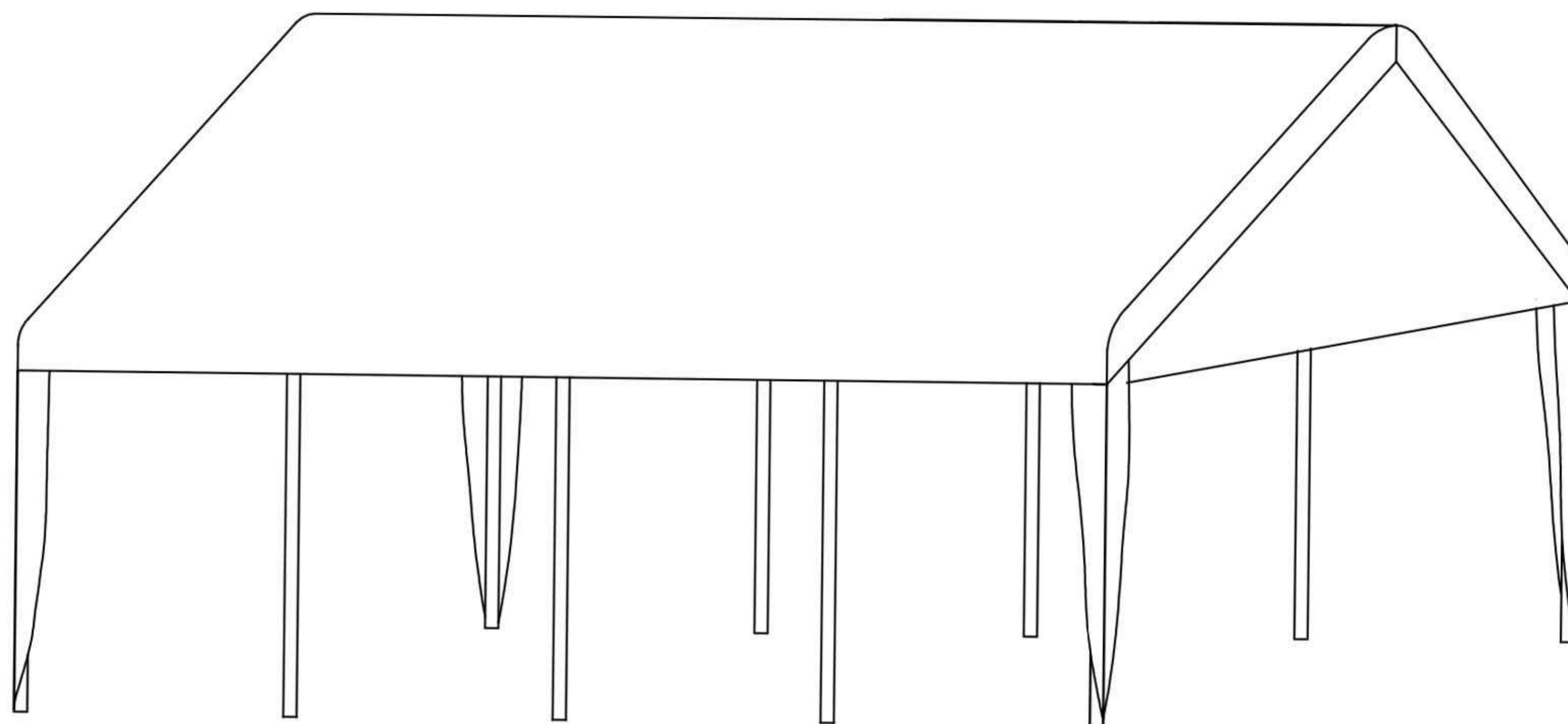
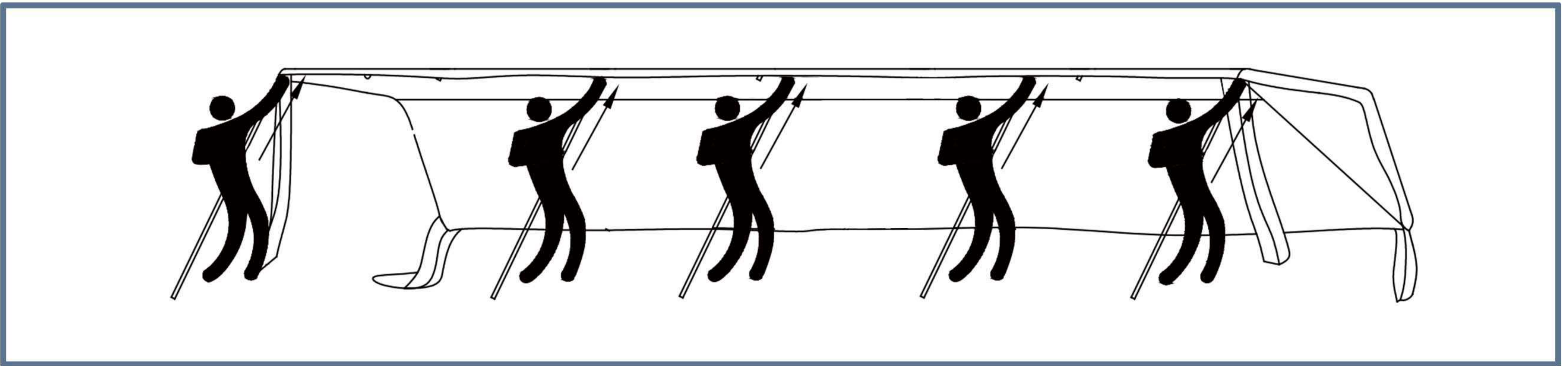
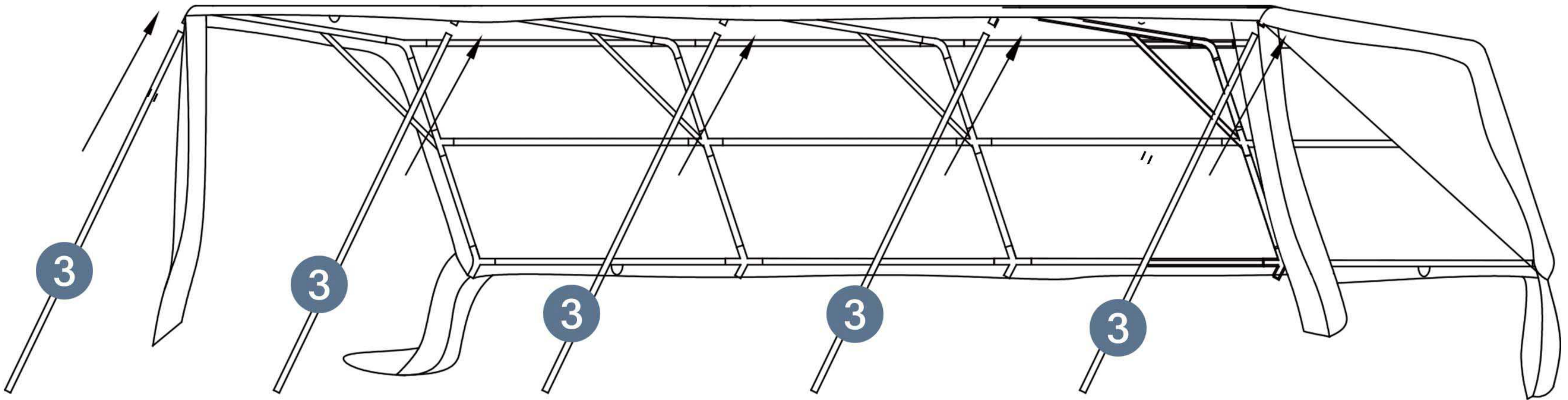

What it looks like after it is set up

Please take care of the screws and contact the after-sales service if there is any problem with the installation or parts.



STEP 6

Parts required

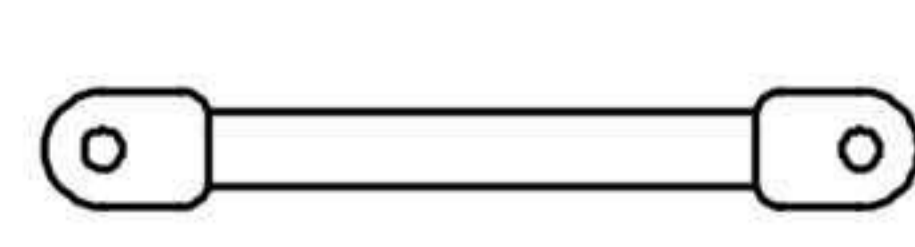

7 8pcs

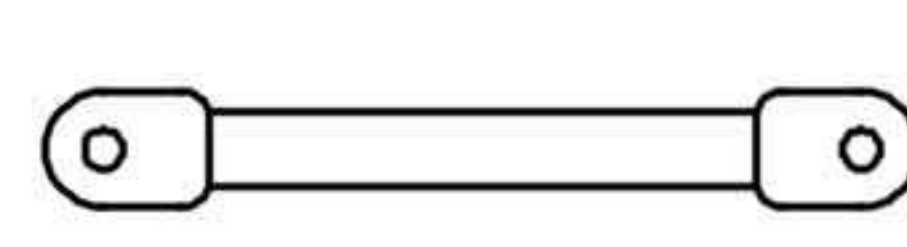

8 4pcs



I 4pcs



J 8pcs



L 10pcs

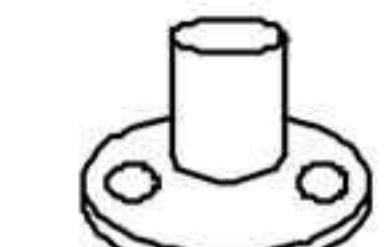

F 10pcs



In order to ensure that the installation is correct, please refer to the p1-1 figure at the bottom of page 4.

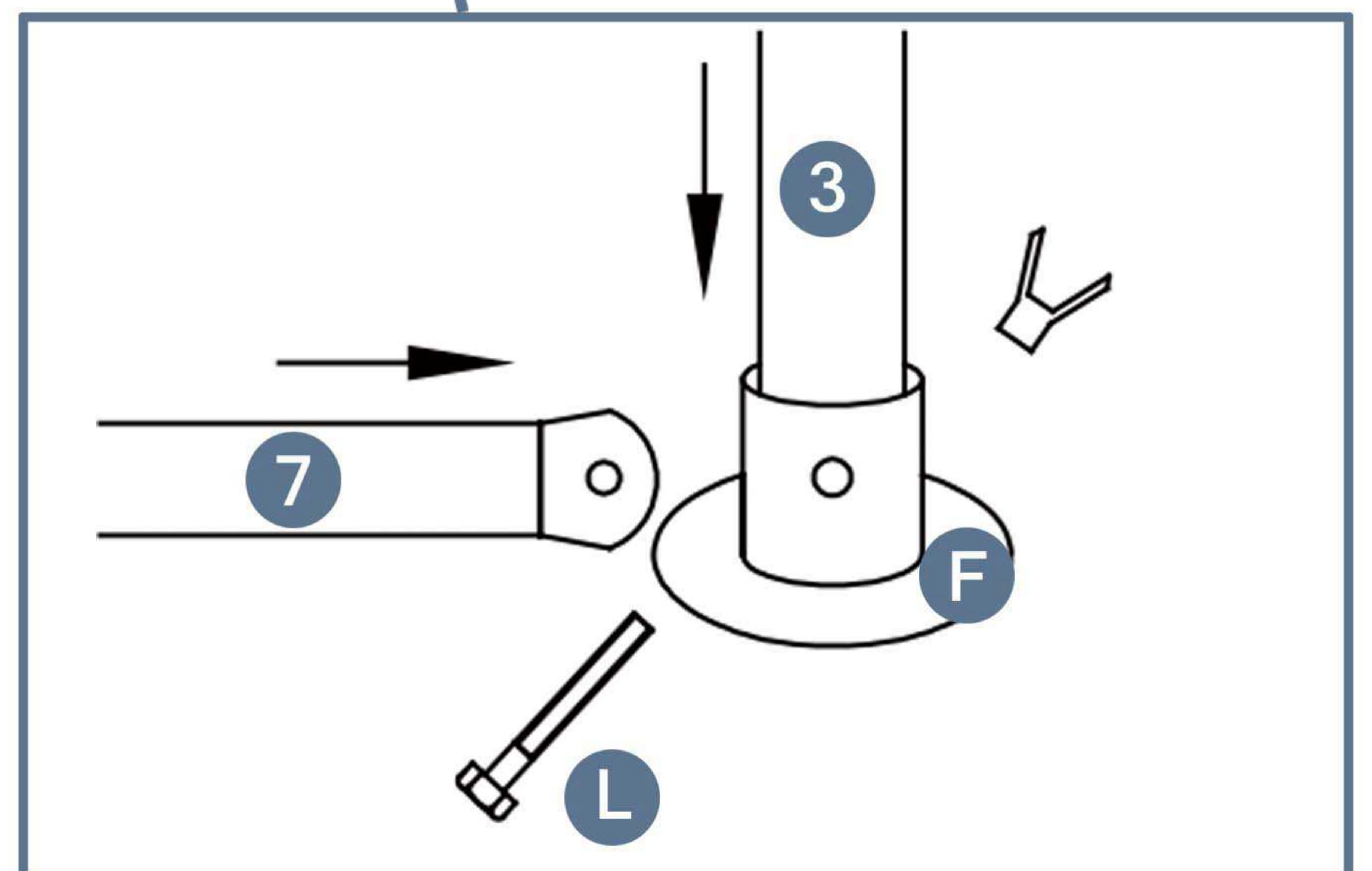
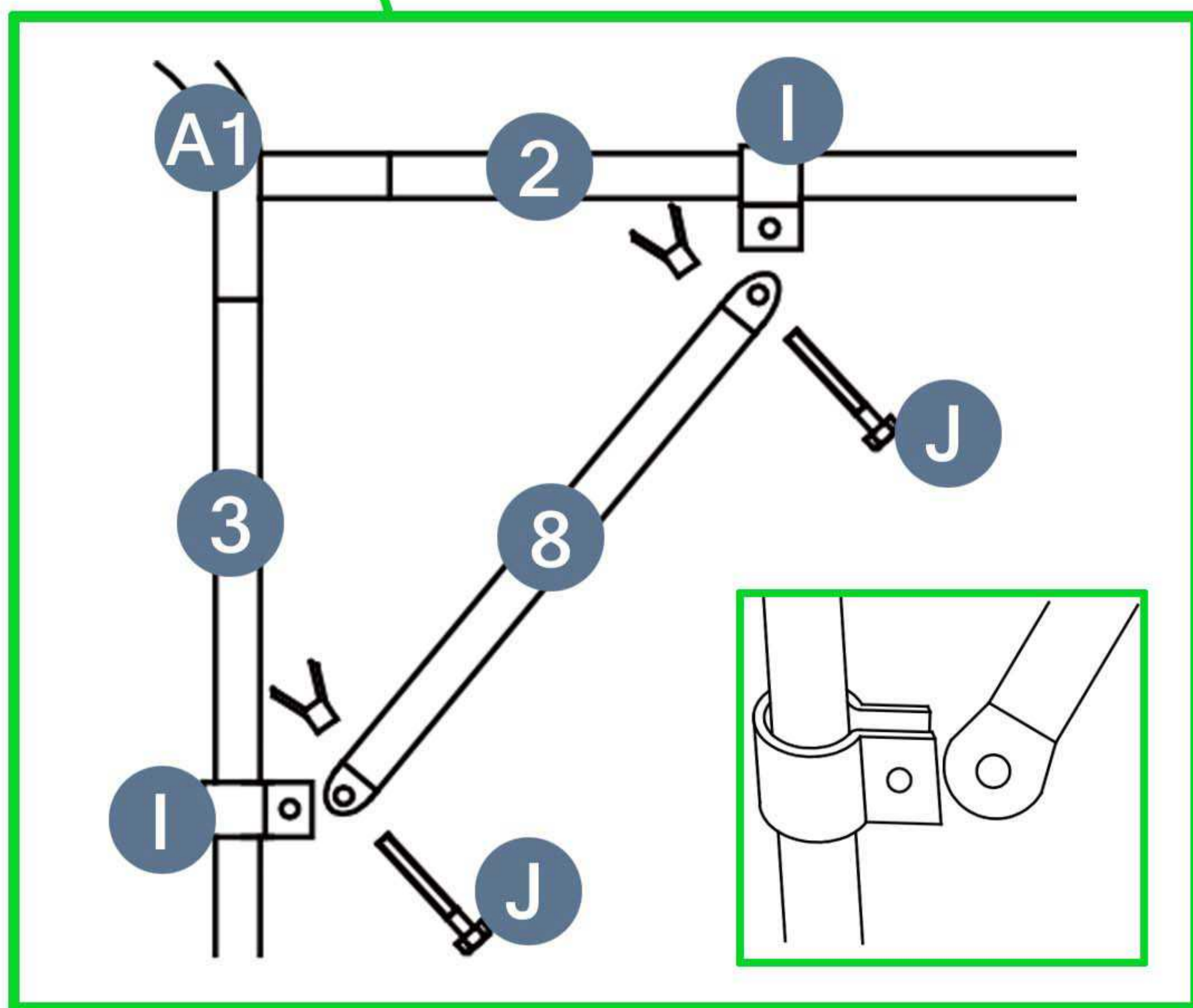
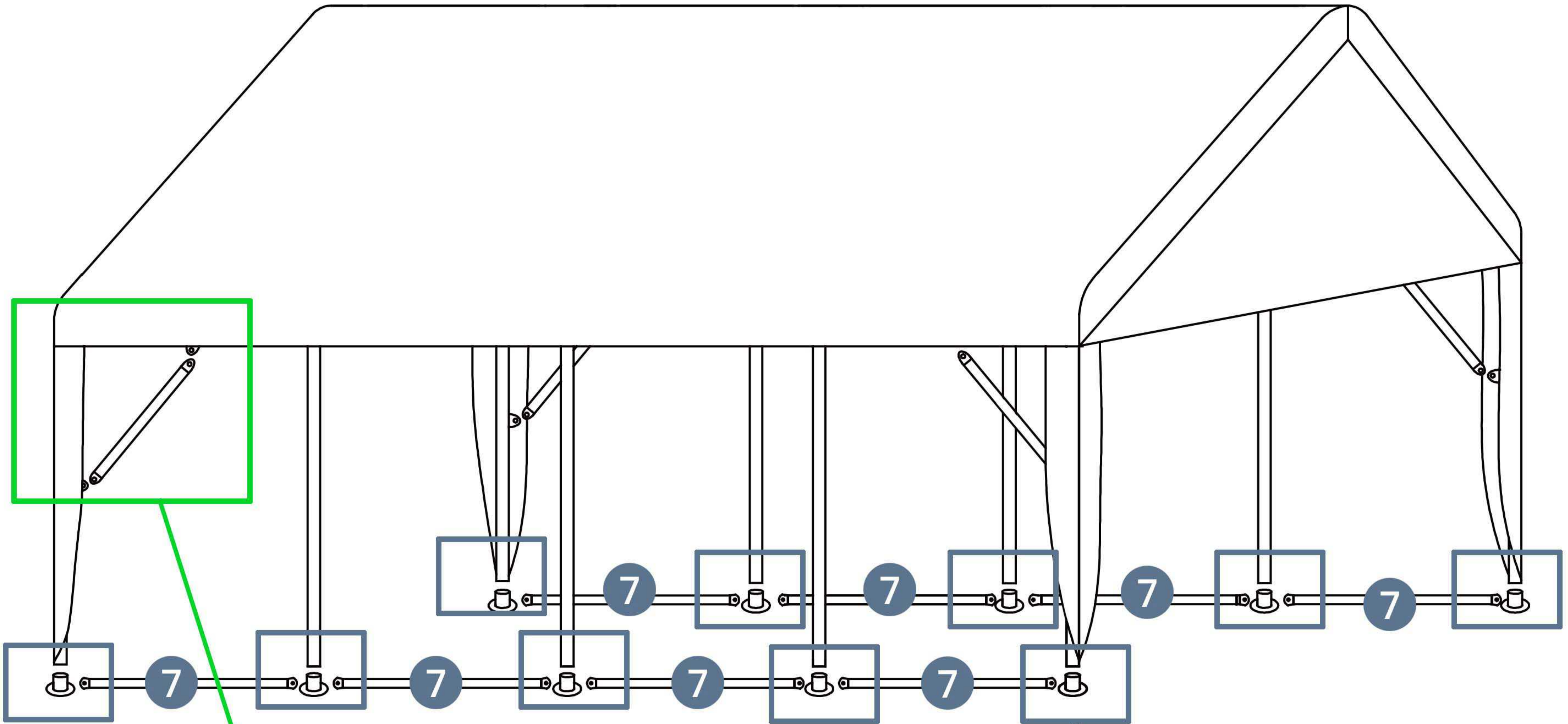

Please take care of the screws and contact the after-sales service if there is any problem with the installation or parts.

➔ ✉ E-mail: cs.helper01@gmail.com

STEP 7

Parts required

-  **N** 18pcs
-  **H** 4pcs
-  **E** 2pcs
-  **O** 4pcs
-  **Q** 2pcs
-  **G** 112pcs
-  **SANDBAG** 4pcs

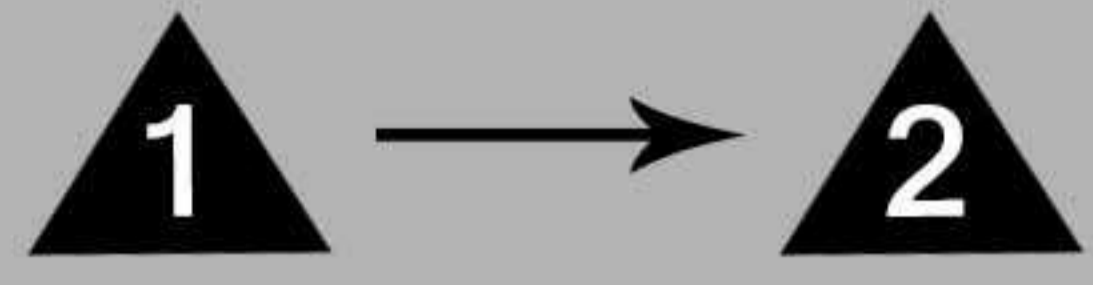

Please install all the G first, and then install the remaining steps.

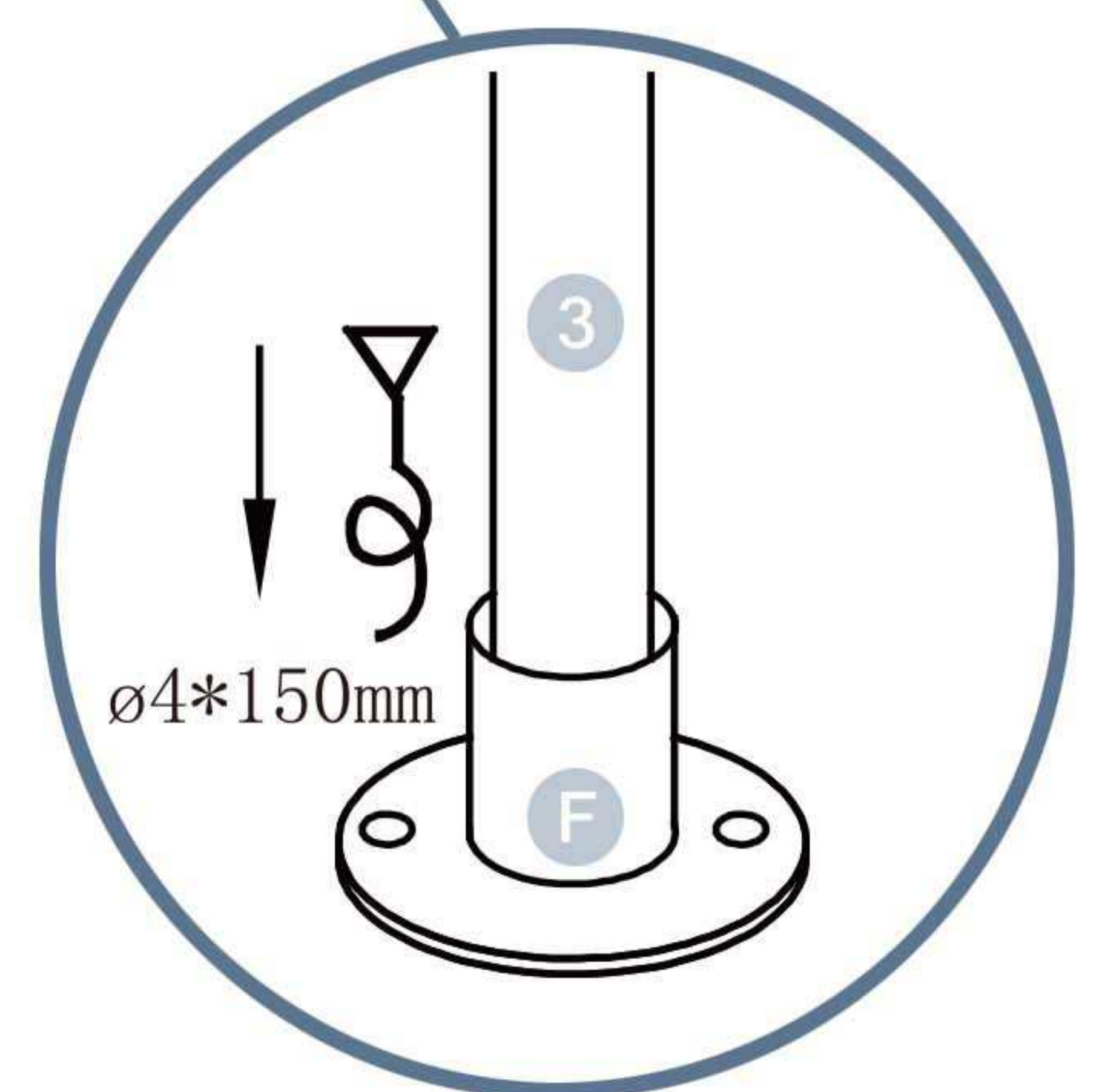
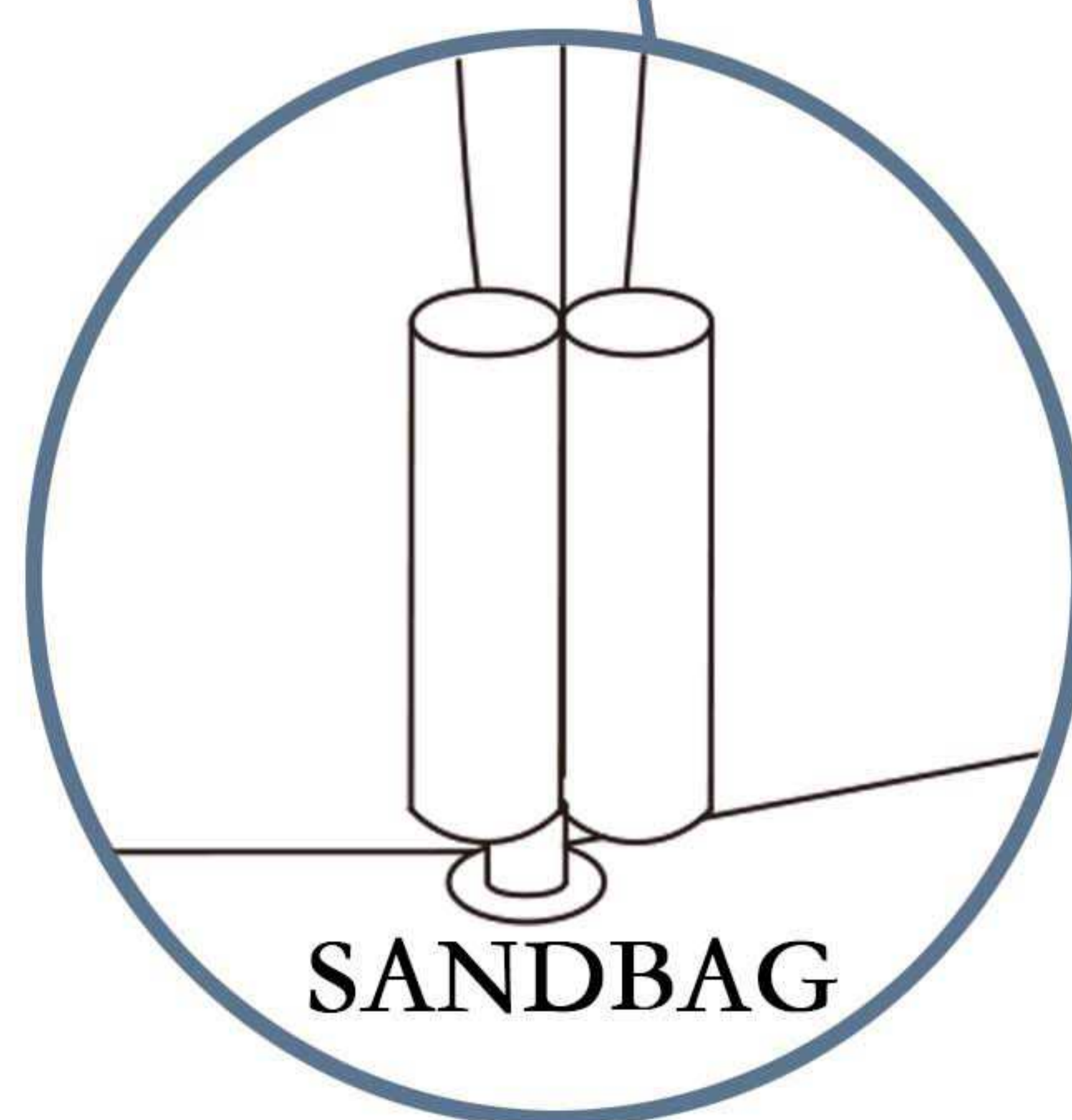
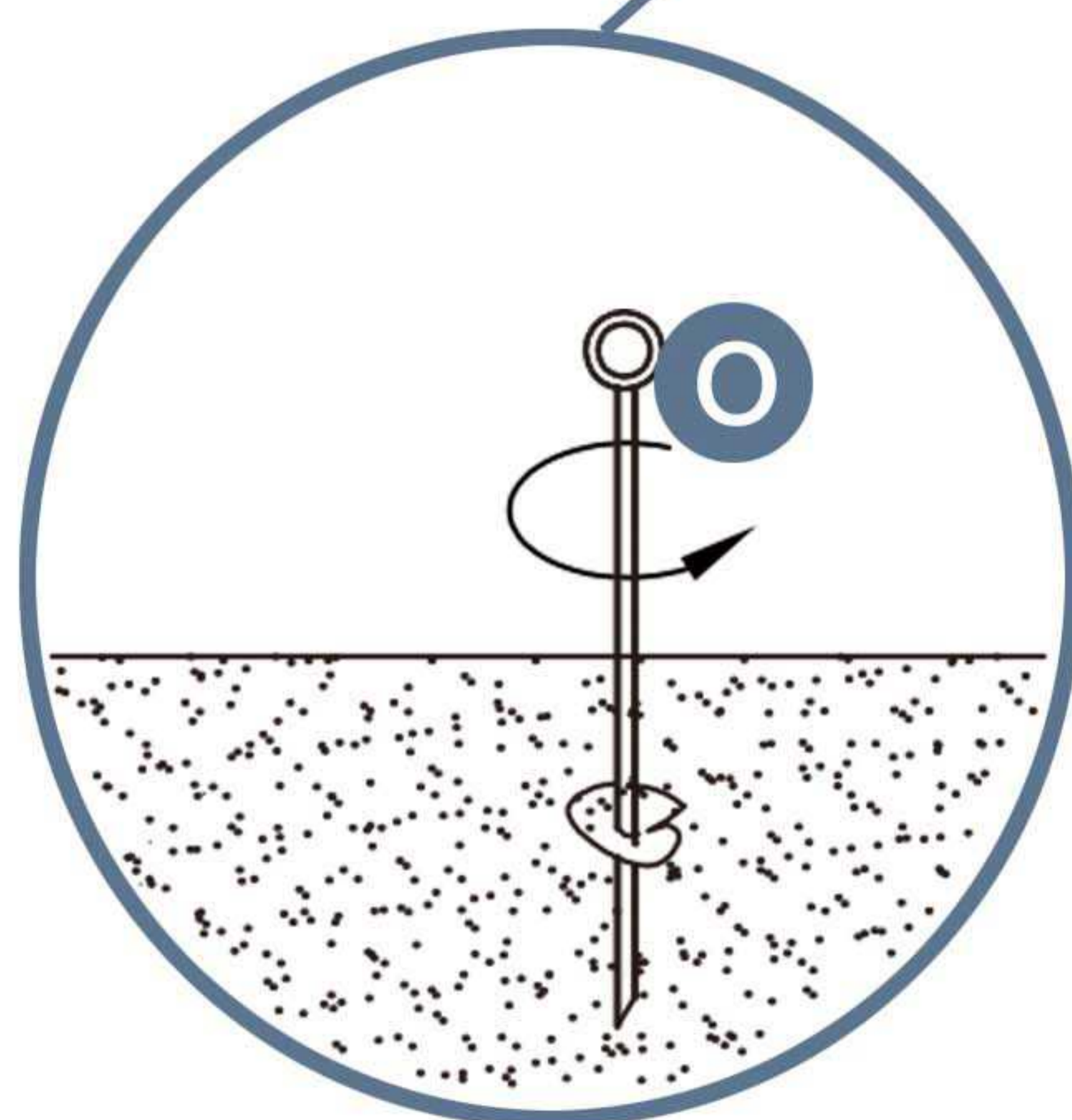
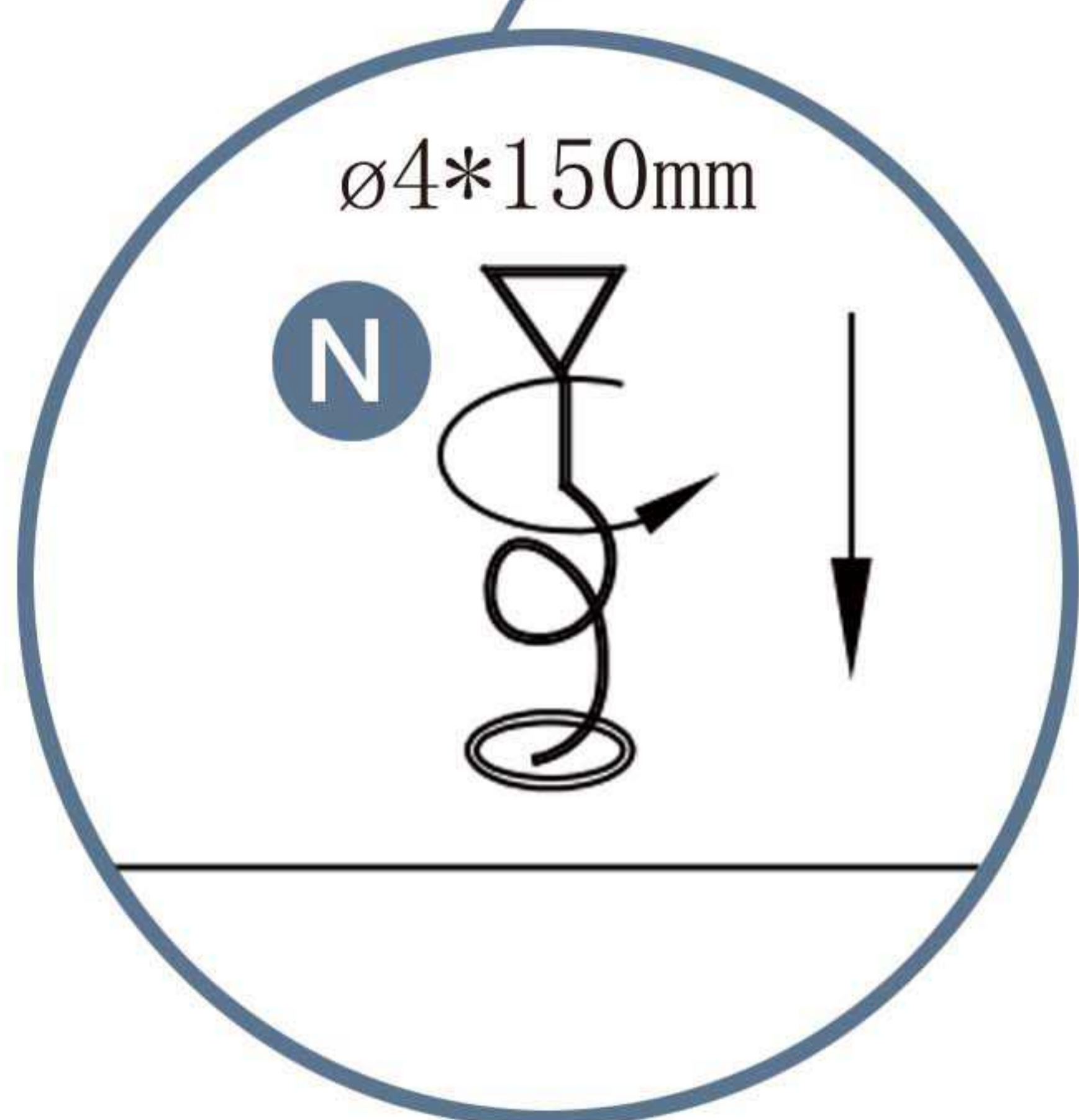
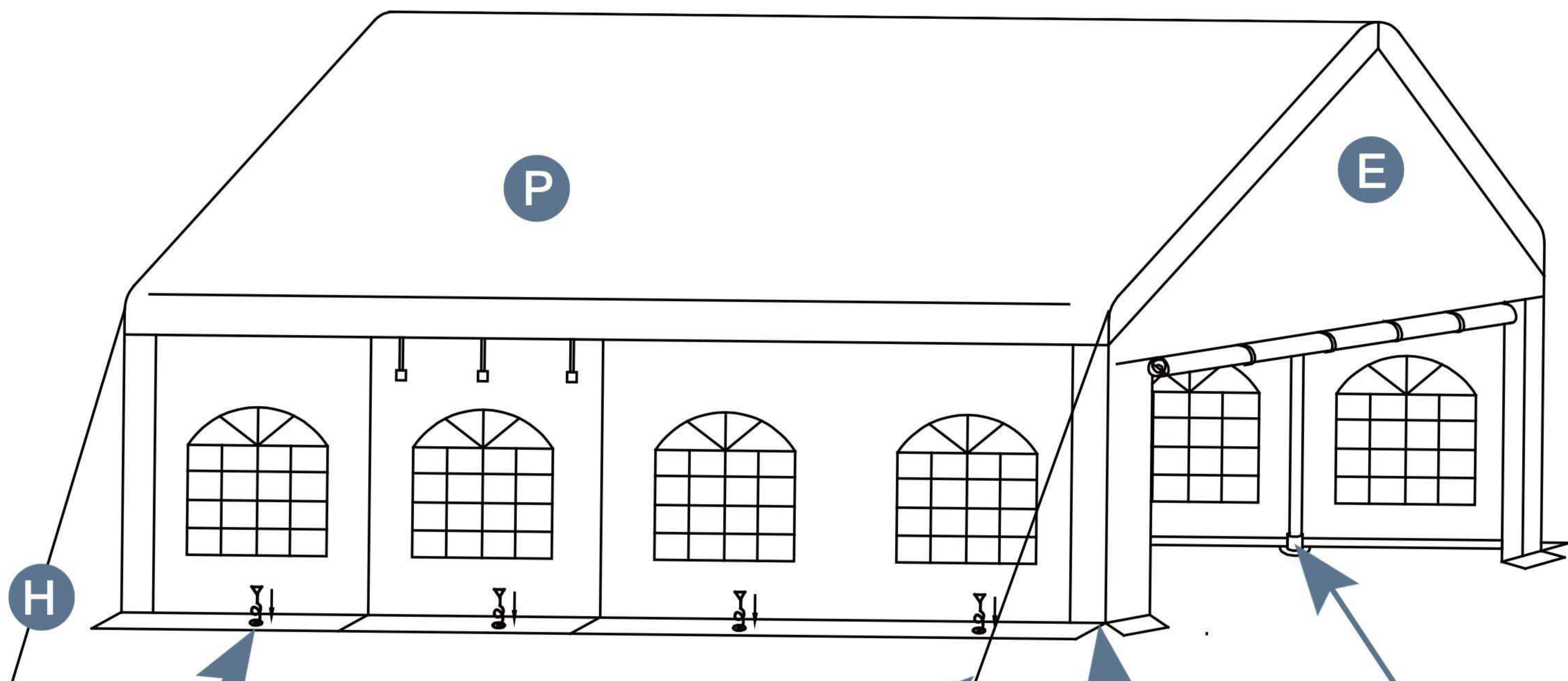
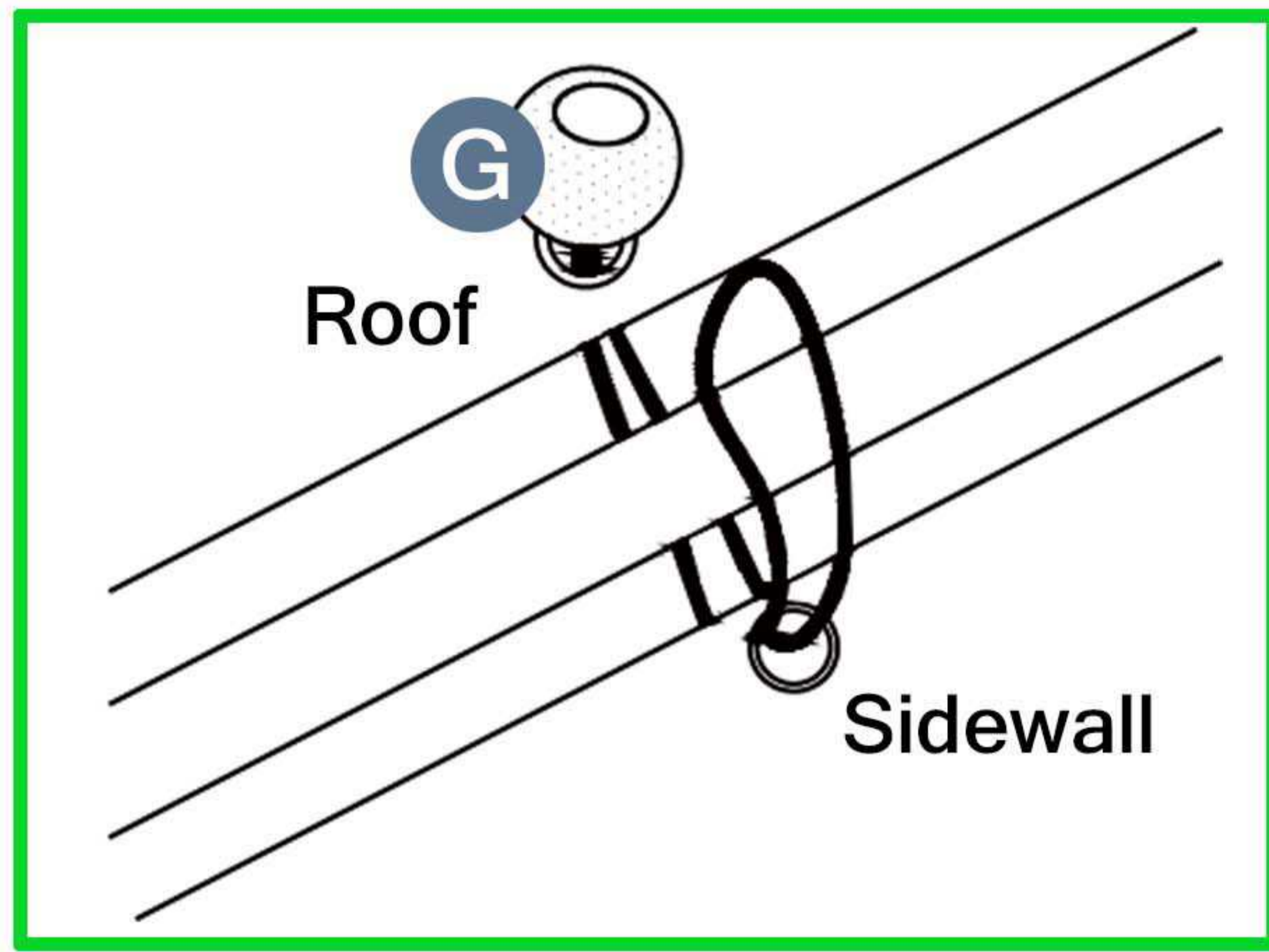

Please take care of the screws and contact the after-sales service if there is any problem with the installation or parts.

➔ ✉ E-mail: cs.helper01@gmail.com