

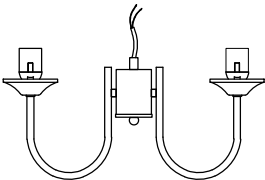







①	 light fixture 1pcs	②	 hanging tube 3pcs	④	 ④ canopy ⑤ cap nut	 ⑦ hex key 1pcs	 X 1pcs	 X 3pcs
			③			 hanging tube 1pcs	⑥	 D7045-3 glass lampshade 3pcs D7045-4 glass lampshade 4pcs

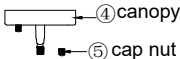

1. Let the wire of the fixture go through the tube ② and tube ③, rotate to install the tubes to the fixture, fasten it with grub screw ⑧ by rotate hex key ⑦.

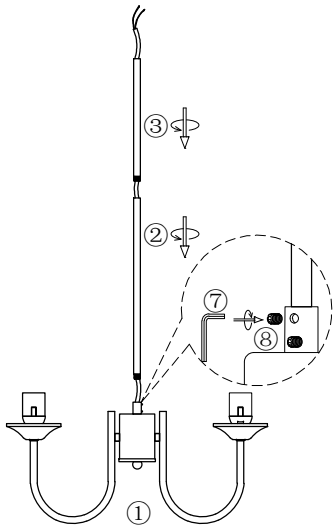
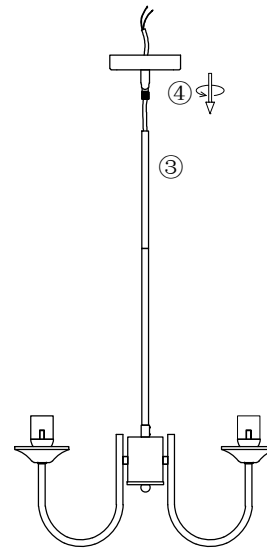

2. Let the wire go through the canopy ④, rotate to install the canopy ④ to the fixture.

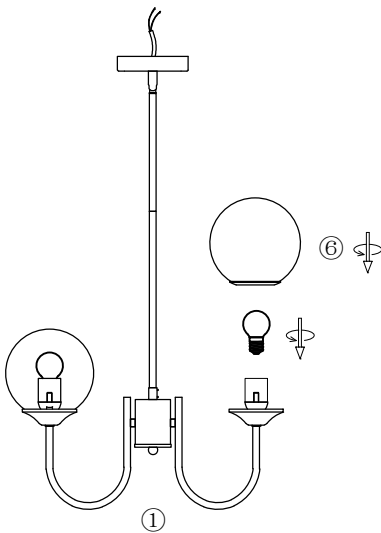

suggest to use G45 ping pong bulb,  
LED Max 7W

3. Install the bulb and rotate to fix the glass lampshade ⑥ to the fixture.

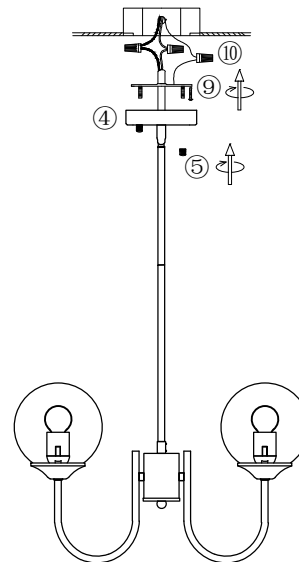

4. Install the bracket to the ceiling junction box with screw ⑨.  
5. Connect the wire to the home line with cap connector ⑩.  
6. Install the fixture to the bracket with cap nut ⑤.

Please read carefully before installation!!!

Note : Please make sure that the electricity is powered off during installation !  
Only a professional electrician should install this kind of product !