

Tribesigns

DESIGNED FOR LIFE

Assembly Instructions

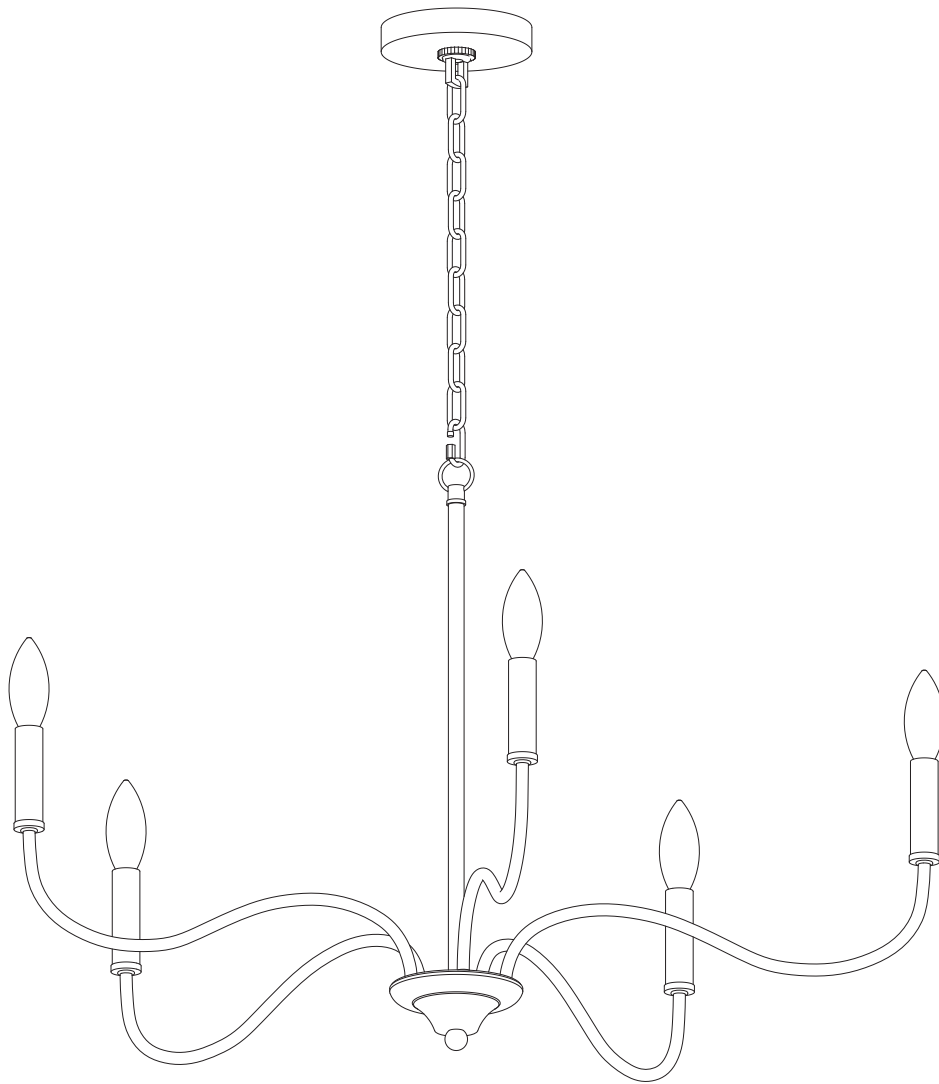

**5-Light Pendant
Light Fixture**

Model No.
THCL-TD0011

 **LITTLE TREE**
Little Tree by Tribesigns

www.tribesigns.com



Contact Us

We're here to help you.



Your satisfaction is our top priority. If you encounter any issues with this product, such as missing or damaged parts, we're here to help. Please retain the original packaging and take photos of the packaging and the product, then contact us as soon as possible.

Warm Tips

1. Carefully read these instructions and keep them for future reference.
2. Check the parts list and confirm everything's there before starting assembly.
3. When assembling, put all parts on a soft, smooth surface like a carpet to avoid scratches.
4. Don't fully tighten screws until all parts are confirmed in place to avoid misalignment.

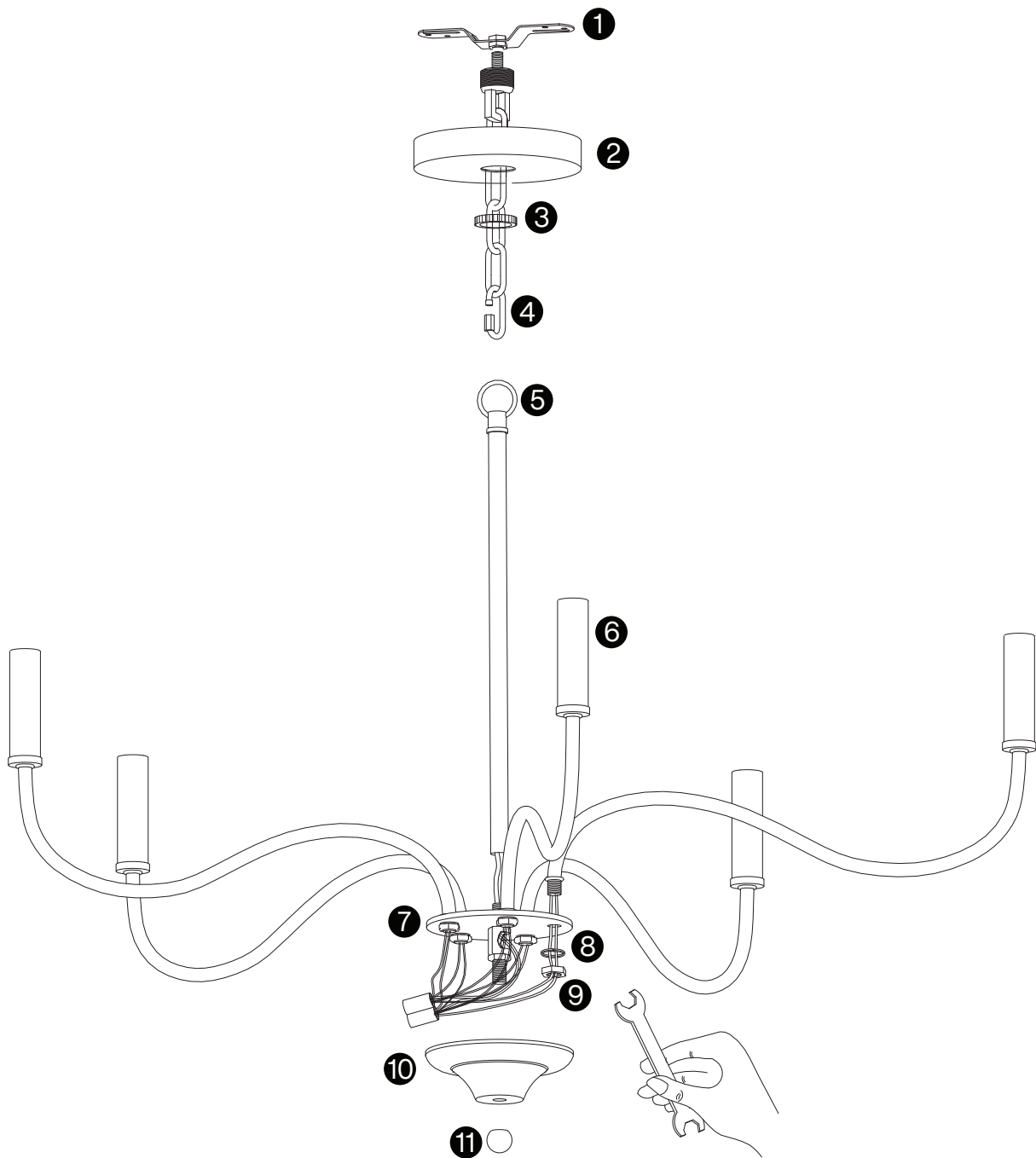

⚠ Caution











Make sure all parts are included. Most board parts are labeled or stamped on the raw edge.

Contact us for a free replacement if you encounter any damaged or missing parts.

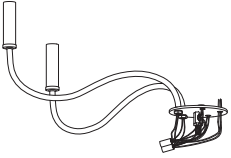

Turn off the main power at the circuit breaker before installing and servicing the fixture to prevent possible injury from electric shock.

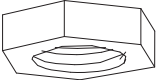

Parts List

 1 1pc	 2 1pc	 3 1pc	 4 1pc	 5 1pc
 6 3 pcs	 7 1pc	 8 3 pcs	 9 3 pcs	 10 1pc
 11 1pc				

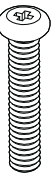
Hardware List

 W-1 2 pcs	 W-2 3 pcs
---	---

Tools Require

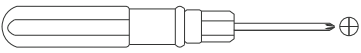
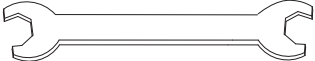
 1pc	 1pc
--	--



1

INSTALL THE LAMP SOCKET

Place the lamp socket(6) into the hole of the fixture base(7), use a wrench(included) to tighten the lamp socket(6) to the fixture base(7) with flat washers(8) and hex nut(9).

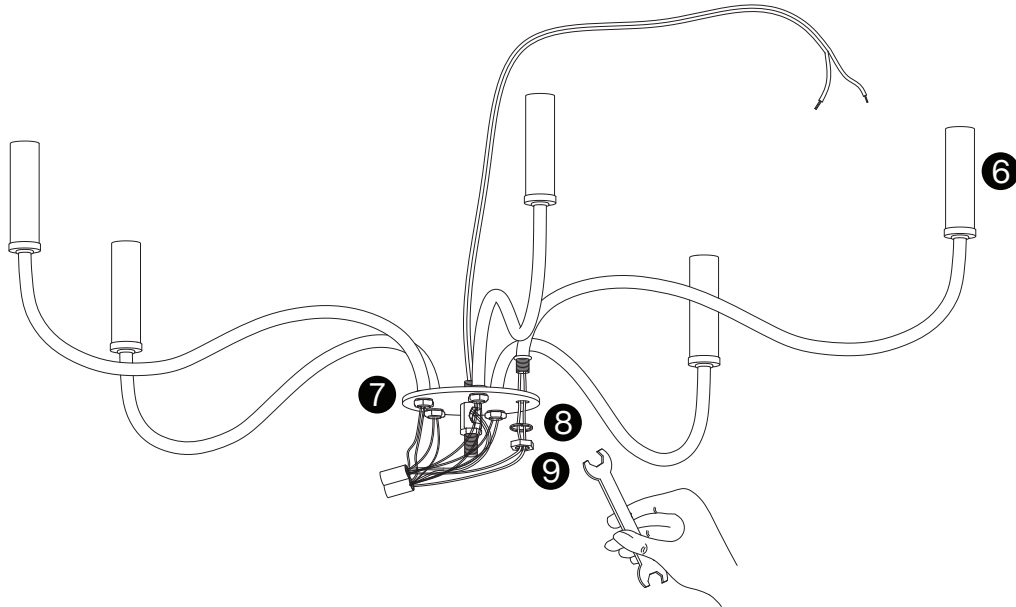

2

INSTALL THE COVER

Align the hole on the cover(10) with the threaded tube on the fixture base and tighten it to the threaded tube with a decorative nut(11).

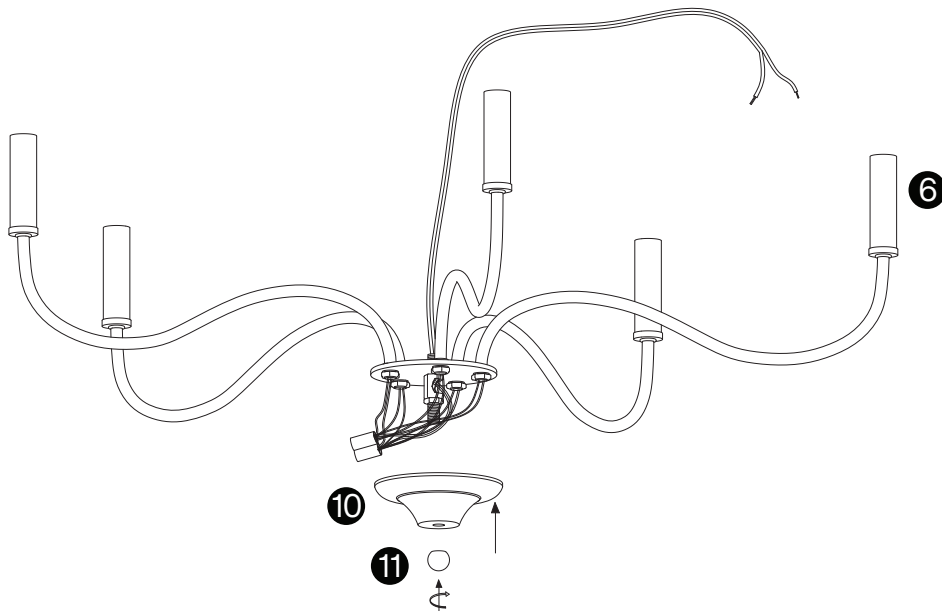



3

ANGLE ADJUSTMENT

Spread the lamp socket(6) evenly at 72°.

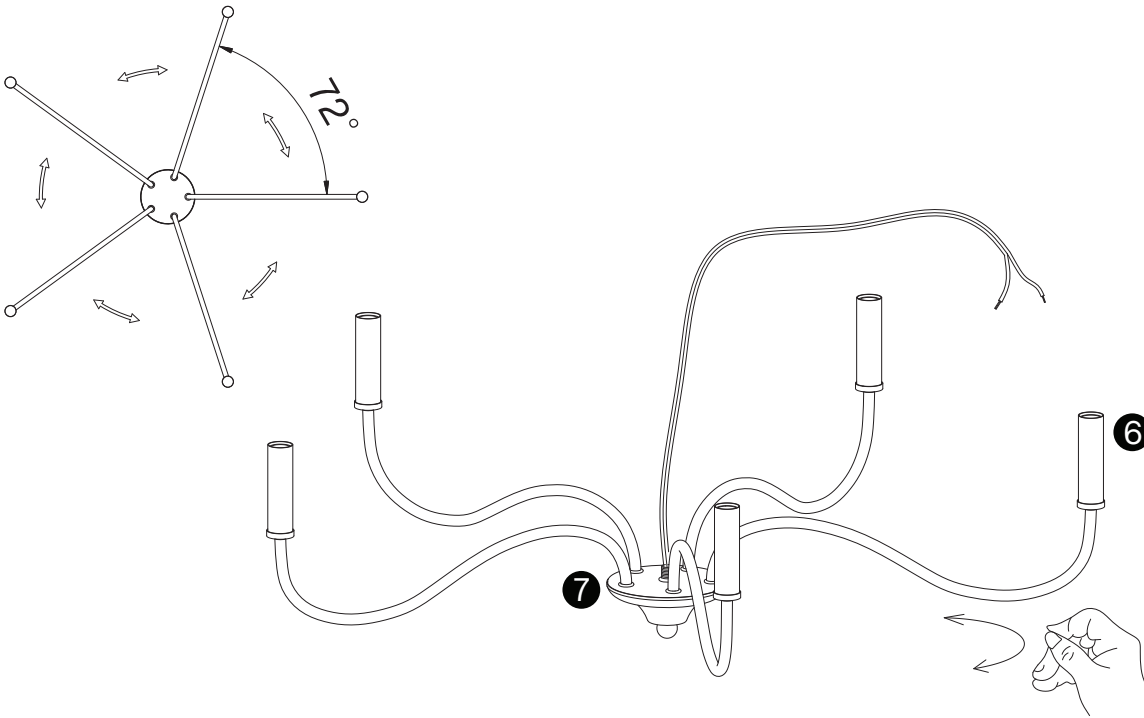

4

INSTALL CENTER TUBE

Thread the wire through the center tube(5), tighten the center tube(5) clockwise onto the fixture base.

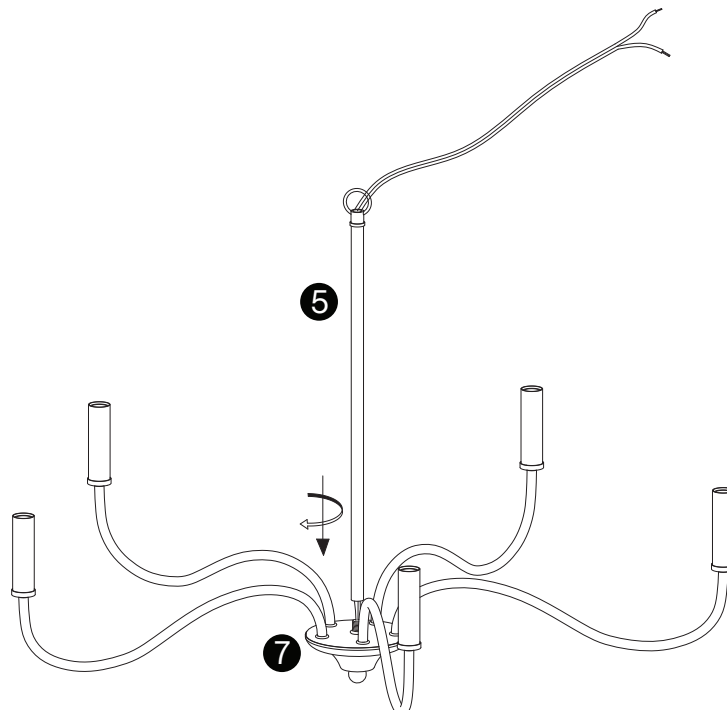



5

INSTALL THE HANGING CHAIN

Thread the wire through the hanging chain(4), locking ring(3), ceiling canopy(2) and mounting bracket(1). Lock the hanging chain(4) to the center tube(5).

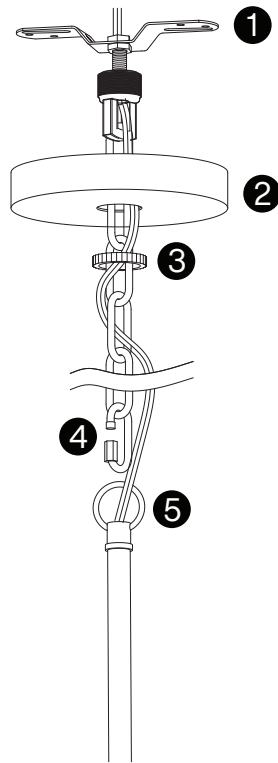

6

CONNECT WIRES

Connect the power supply wires to the fixture lead wires by connecting the black fixture wire to the black supply wire, and the white fixture wire to the white supply wire using wire connector(W-2). Connect the fixture ground wire to the house ground wire by fixed on the mounting bracket(1). Carefully tuck all wiring back into the outlet box(not included).

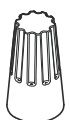
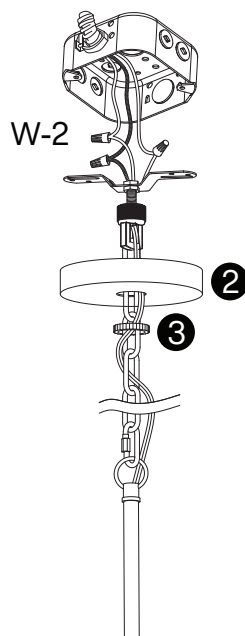

W-2
3 pcs



7

INSTALL MOUNTING BRACKET

Attach the mounting bracket(1) to the outlet using the slotted holes on the mounting bracket(1), use a Phillips screwdriver(not included) to tighten the mounting screw(W-1) to the outlet box(not included) until the mounting bracket(1) is secured on the outlet box(not included).

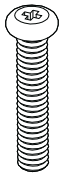
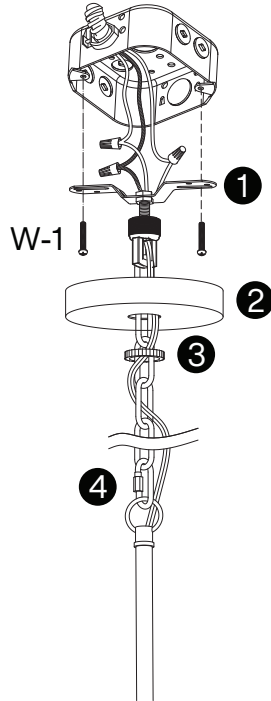

W-1
2 pcs

8

TIGHTEN THE CEILING CANOPY

Tighten the hanging chain(4) to the mounting bracket(1). Align the ceiling canopy(2) over the outlet box(not included). Secure the ceiling canopy(2) into place using the provided hanging ring(3) and tighten until secure.

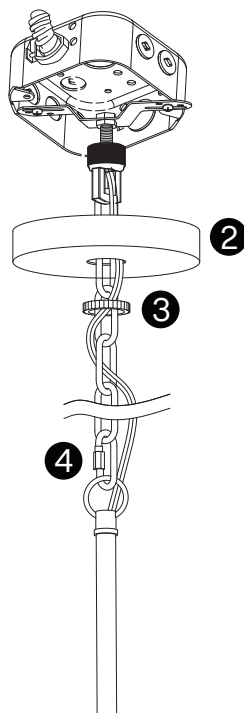



9

INSTALL BULB

Install light bulb(not included) in accordance with the fixture's specifications. Do not exceed the maximum recommended wattage.

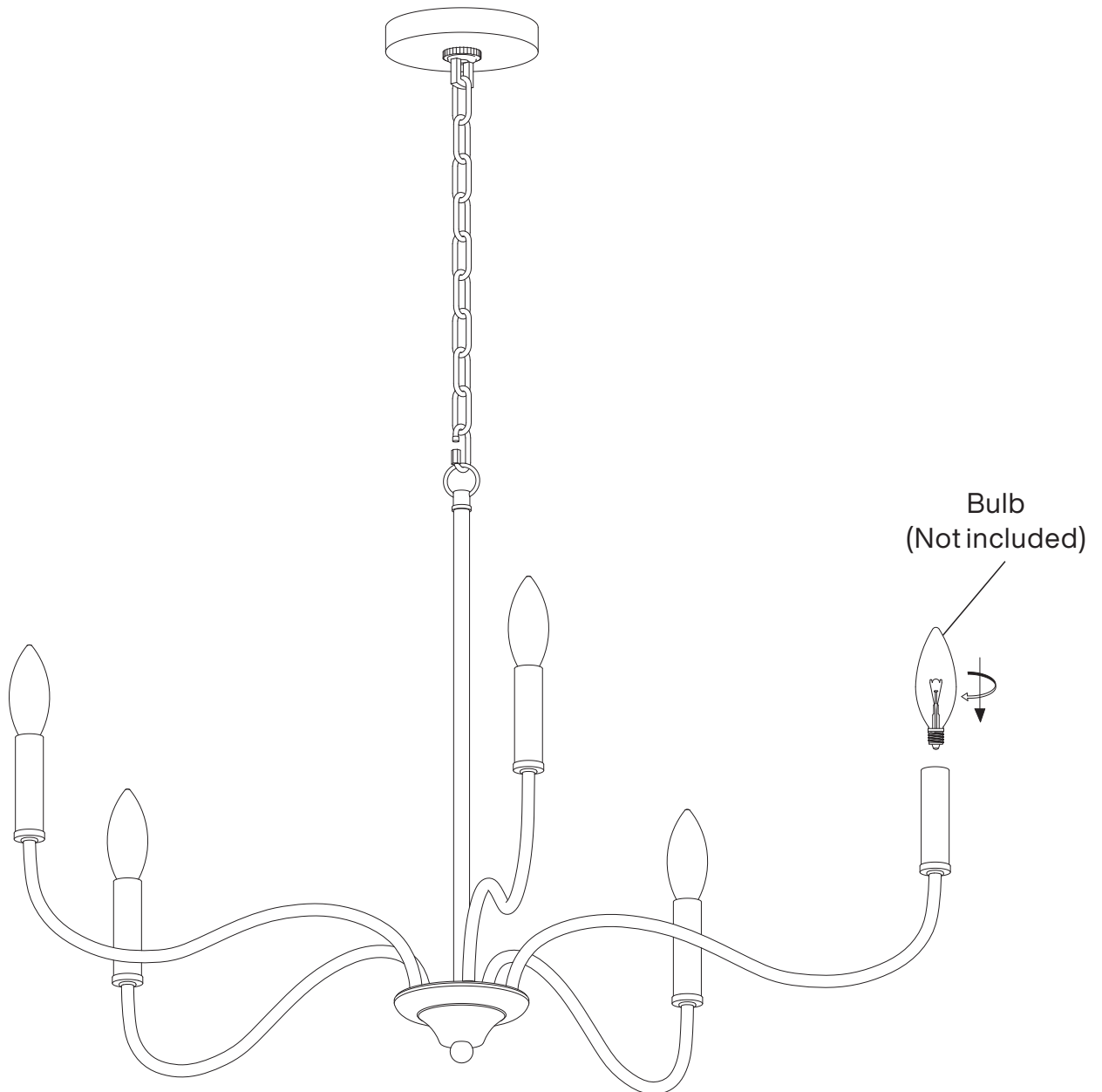



DESIGNED FOR LIFE

Thank you for your support!

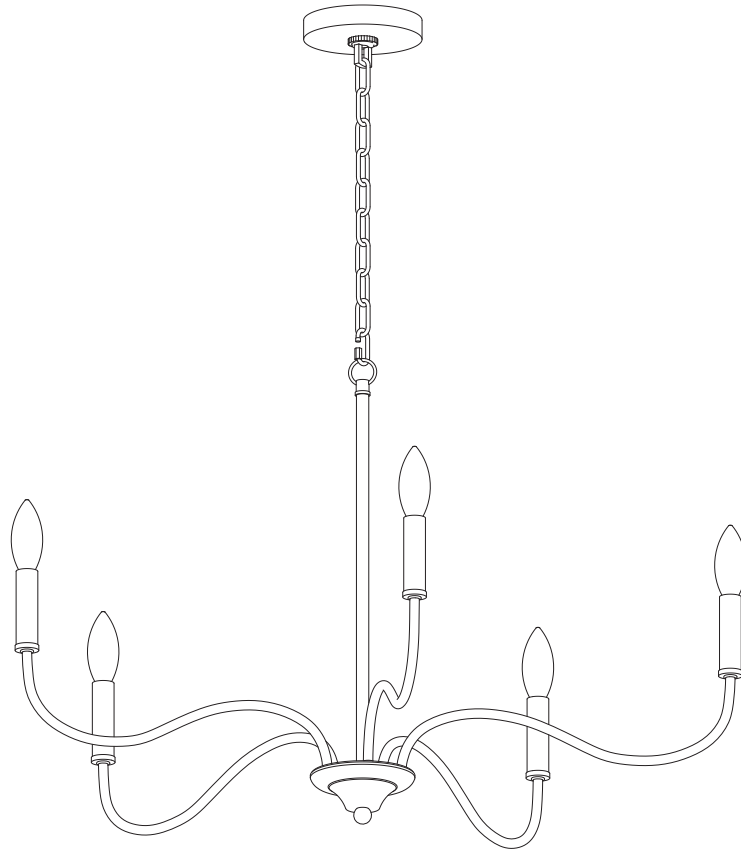

Contact our customer service team



support@tribesigns.com
www.tribesigns.com



1-424-220-6888

7 AM to 8 PM EST,
Monday to Friday.

Follow Tribesigns



Facebook



Instagram



Pinterest



Twitter



YouTube



TikTok



WhatsApp