

4*6 FT Storage Shed Installation

TSS002-N01-S

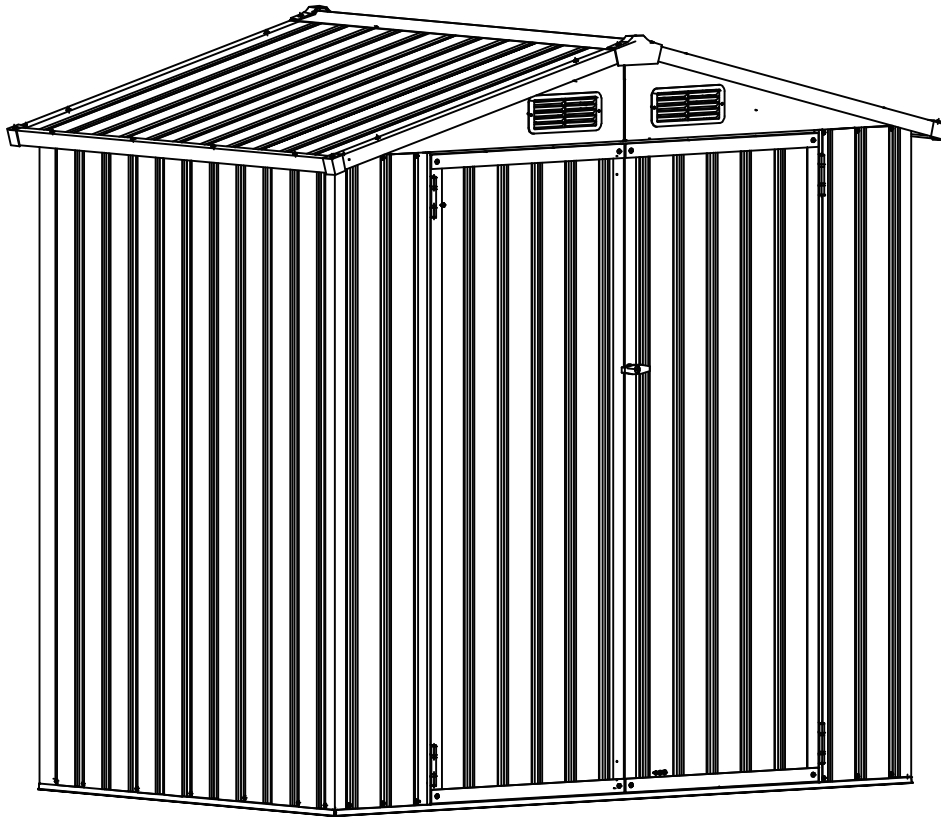

Thank you for choosing us!

Our goal is to provide high quality outdoor furniture with outstanding customer service-all at an affordable price.

Please let us know if you have any concerns.

1. Please wear gloves to avoid injury!
2. Send us an email at customerservice@lausaint.com, we will reply to you as soon as possible.



The product comes in two cartons. Please install after receiving all cartons.

Please prepare below tools before installation. (Not Included)

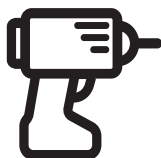

Electric Screwdriver



+ Manual Screwdriver



Ladder

Package included Tools



Gloves X 1 Pair



Spanner X 1

ATTENTION:

1. Please read this instruction carefully before installation and follow it strictly during installation.
2. Ensure that there are no problems later due to installation errors.
3. We have prepared extra screws for you to use in case of loss or damage.

Installation Notes

Please check the quantity of all parts before installation (Please refer to the Parts Lists) and the appearance of the products. Please make sure the product is correct before installation. If there is any problem, please contact us directly.

Make sure the colored panels are facing outwards and all the holes match. The panels are textured, please install the panels in the order specified in the instructions. All lines and holes must be accurately matched to make the storage shed more stable. Please ensure that all screws are tightened to prevent the product from falling apart.

There is a protective film on the surface to protect the product, please tear it off after installation to get the final presentation. If you do not damage the film during installation, it can also remain on the product to protect the product.

Please place the product on a flat ground to prevent leaning and collapse. If the ground is uneven, the door may can't be closed.











Safety Precautions































We recommend **two adults** to complete the installation. Two adults installed together will make the installation process easier and safer.

The gloves must be carried to prevent hand cuts during installation.

Take care when using power tools near water the use of a residual current device (RCD) is advised. Please use the electric driver carefully during screwing to prevent the screw from slipping and hurting your hand. (We recommend that beginners use a manual screwdriver for installation.) Be careful not to fall when installing the roof. Please steady the ladder and make sure the product placed on a flat ground.

PLEASE KEEP THIS INSTRUCTION FOR FUTURE REFERENCE.

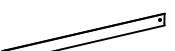
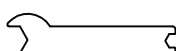
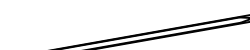
Carton 1/2 Component List						
	K46-7L	2			W3	2
	K46-7M	2			W5-K	2
	K46-7R	2			W2-HL	1
	W5-C	4			W2-HR	1
	W5	6				

Carton 2/2 Component List						
PART	NO.	QTY.		PART	NO.	QTY.
	K46-1	2			GC	4
	K46-2	2			GE	2
	K46-3	2			GF	4
	K46-4	2			T-F	4
	K46-5L	2			F1	232
	K46-5R	2			F2	39
	K46-6	2			F3	32
	K46-8	4			V2	218
	K46-9	2			F4	4
	K46-10	1			DC	2
	UA	2			C2	4
	DA	2			DH	4
	DLA	1			GL	1
	DRA	1			SL	38
	DDA	4			M20	1
	DBA	4			ST	1
	C3	4				

Component List

Shed top panels

NO.	QTY.
K46-7L	2
K46-7R	2
K46-7M	2
K46-8	4
K46-9	2
K46-10	1
GC	4

NO.	QTY.
GE	2

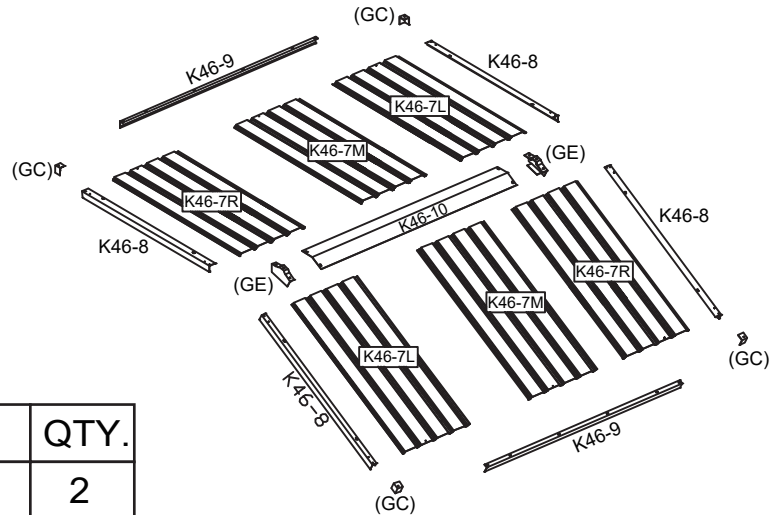

Shed top frame

NO.	QTY.
K46-3	2
K46-4	2
K46-5L	2
K46-5R	2
K46-6	2
C2	4
C3	4
GF	4

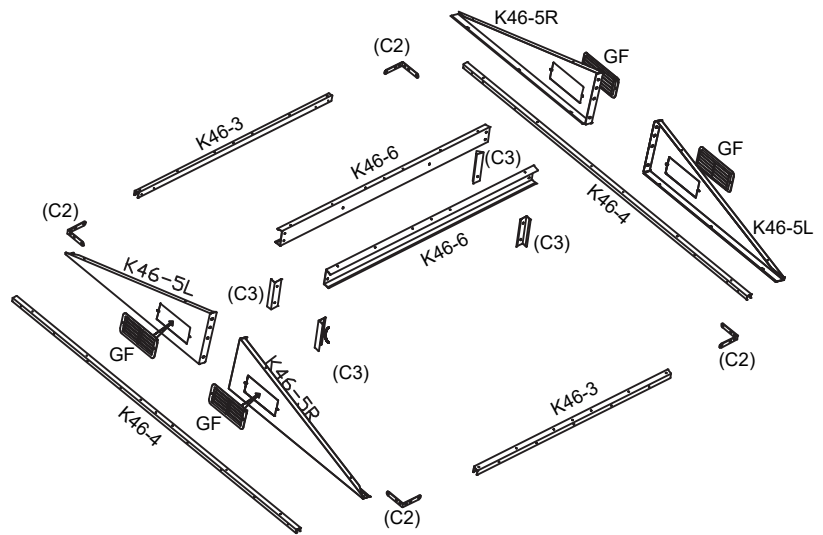

Door

NO.	QTY.
DA	2
UA	2
W5-K	2
W2-HL	1
W2-HR	1
DDA	4
DLA	1
DRA	1
DBA	4
DH	4
DC	2

Shed base

NO.	QTY.
K46-1	2
K46-2	2
T-F	4

Shed side

NO.	QTY.
W5	6
W5-C	4
W3	2



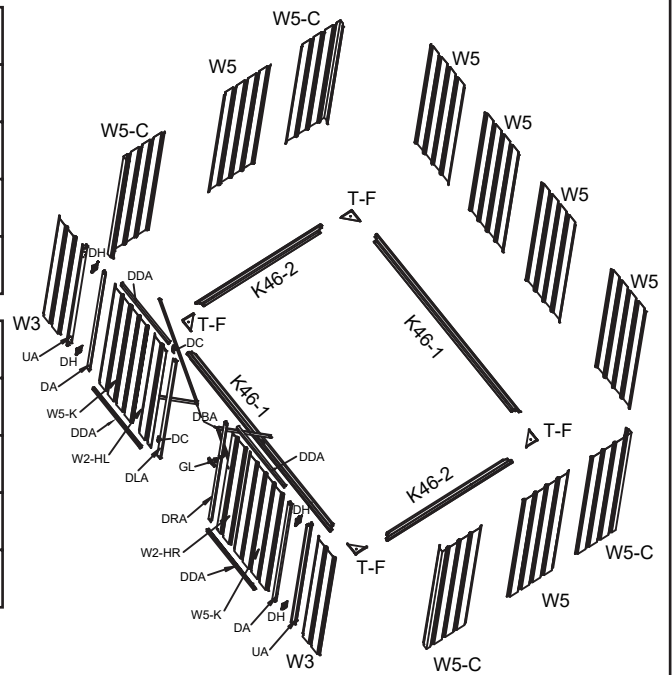

GL	1
----	---

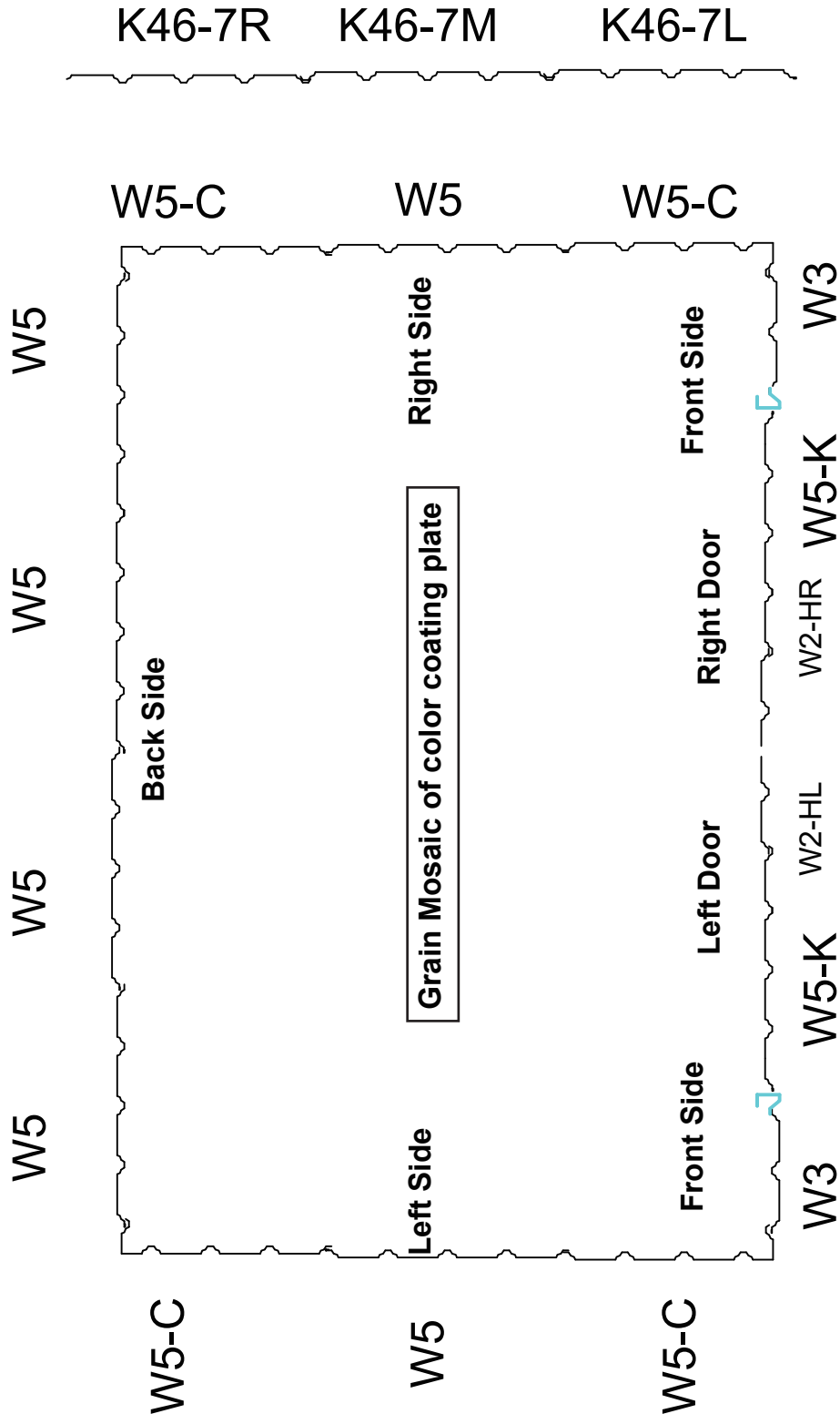

Top Plate

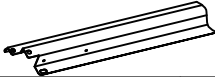
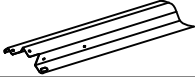

Shed Base Frame Assemble

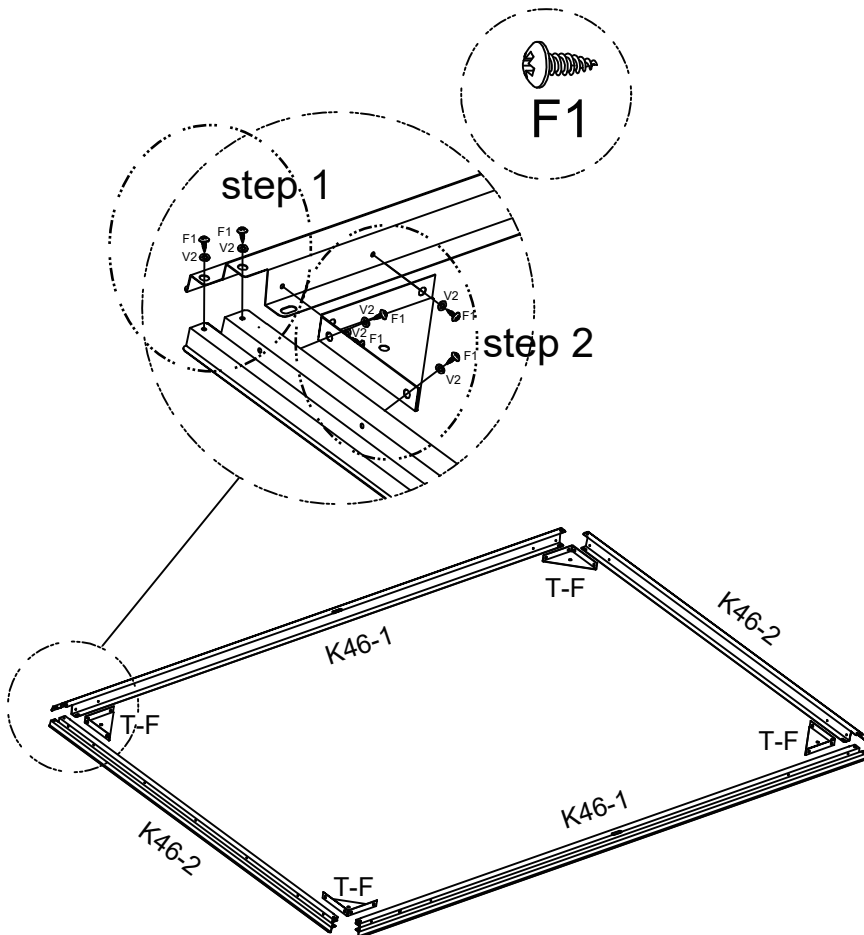

PART	NO.	QTY.
	K46-1	2
	K46-2	2
	T-F	4
	V2	24
	F1	24

 Note: The larger hole is always covered over the small hole.

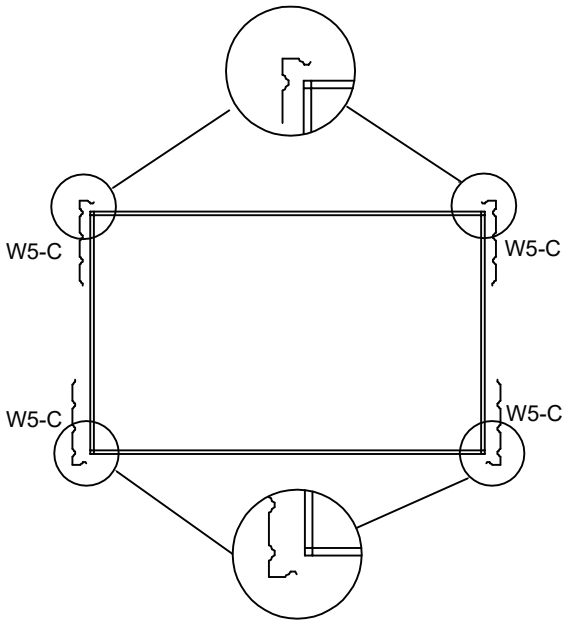

Shed Side Panels Assemble



PART	NO.	QTY.
	W5-C	4
	V2	12
	F1	12

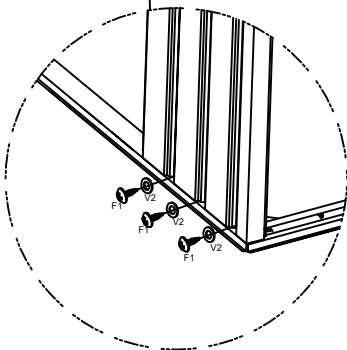
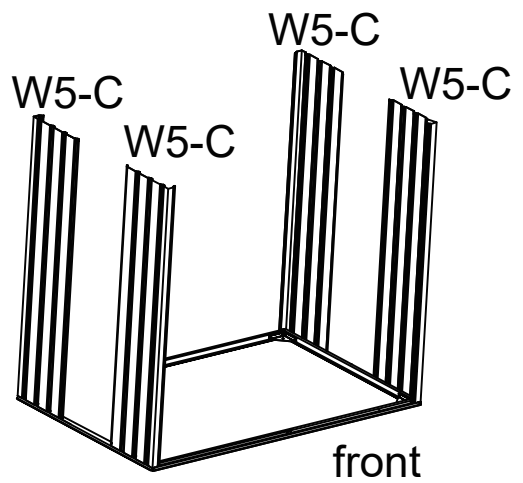
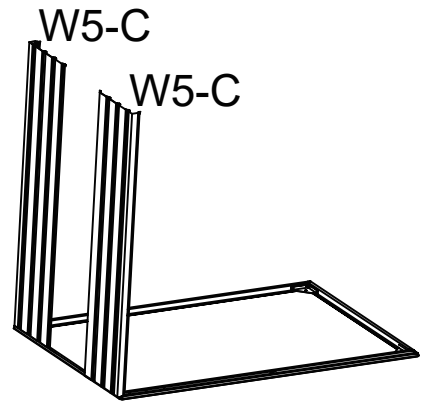
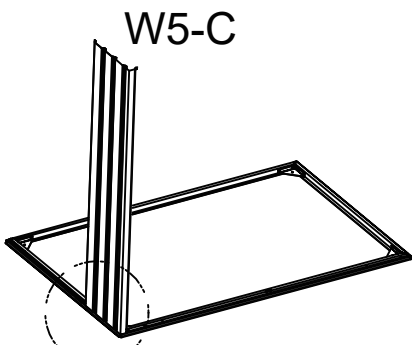



Two Adults Are Required

PART	NO.	QTY.
	K46-3	2
	K46-4	2
	F1	28
	V2	28
	C2	4

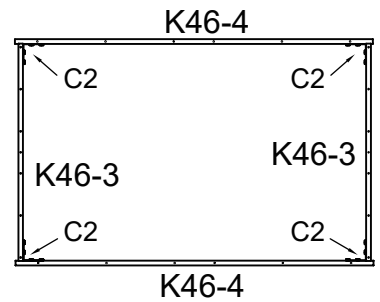
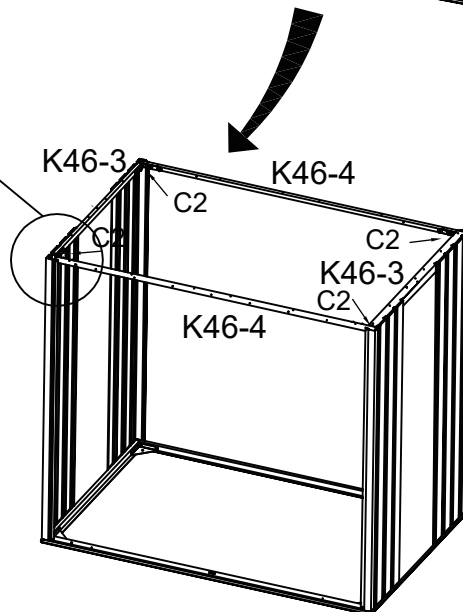
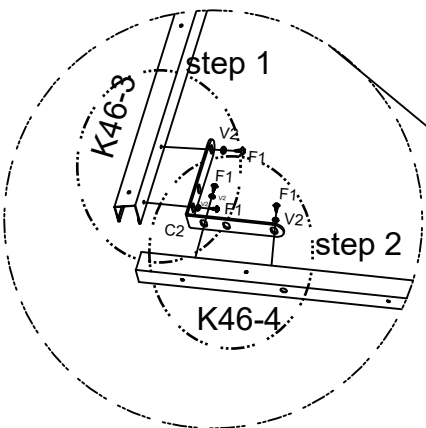
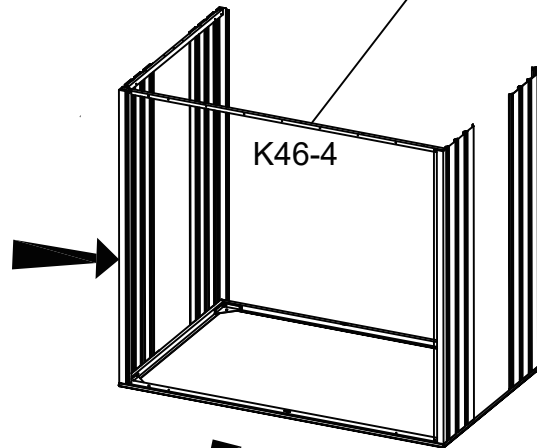
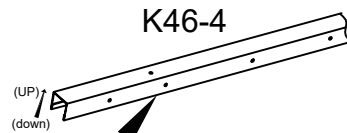
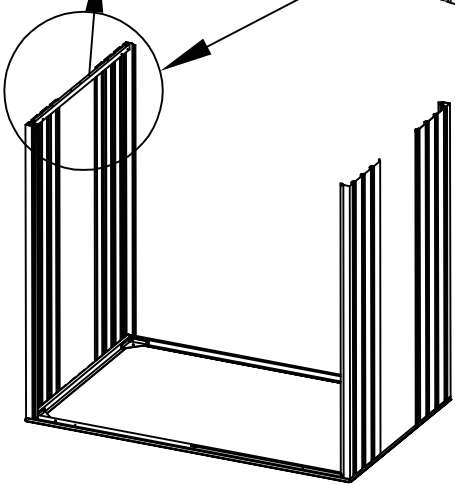
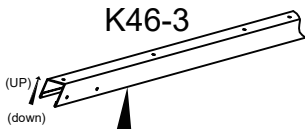
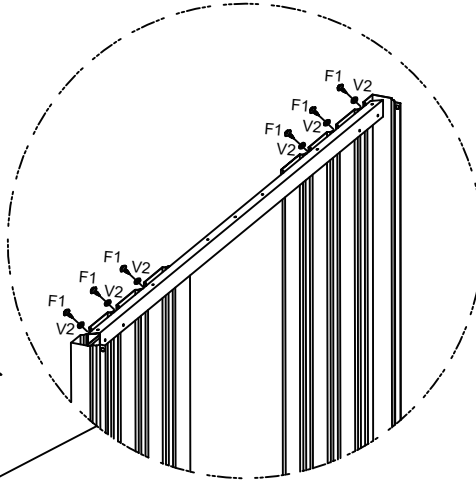

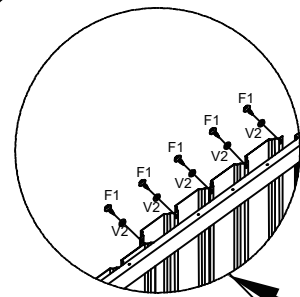

PART	NO.	QTY.
	W5	2
	F1	20
	V2	20
	F2	4

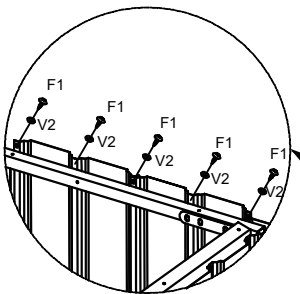
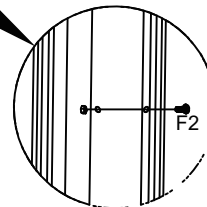
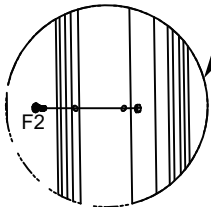
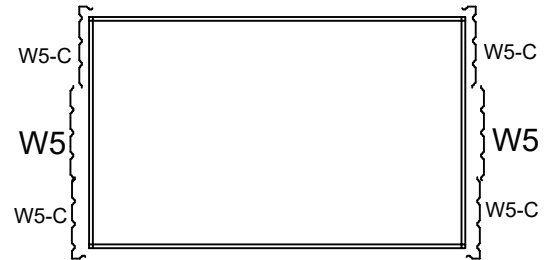
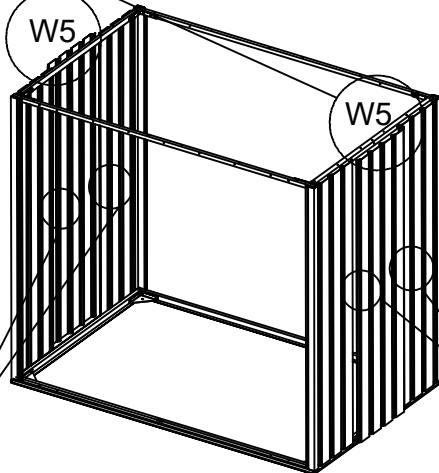



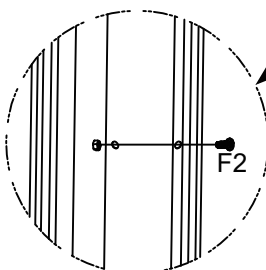
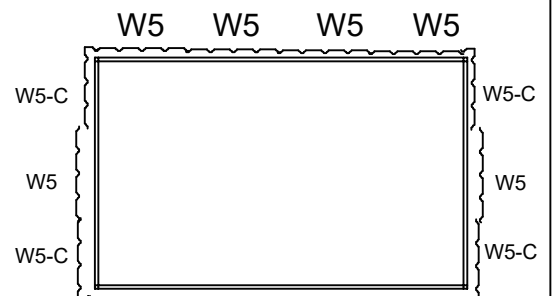
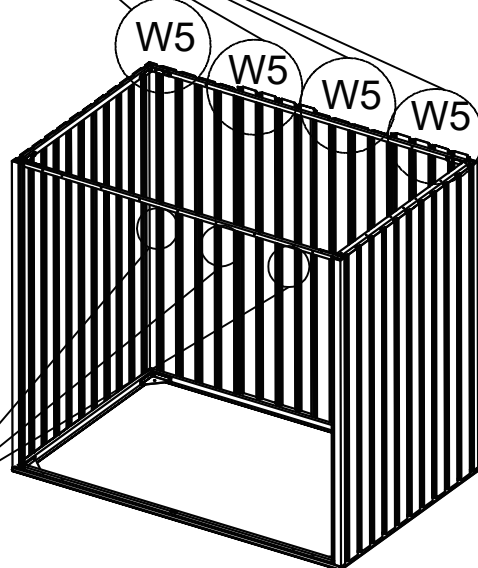

PART	NO.	QTY.
	W5	4
	F1	34
	V2	34
	F2	5

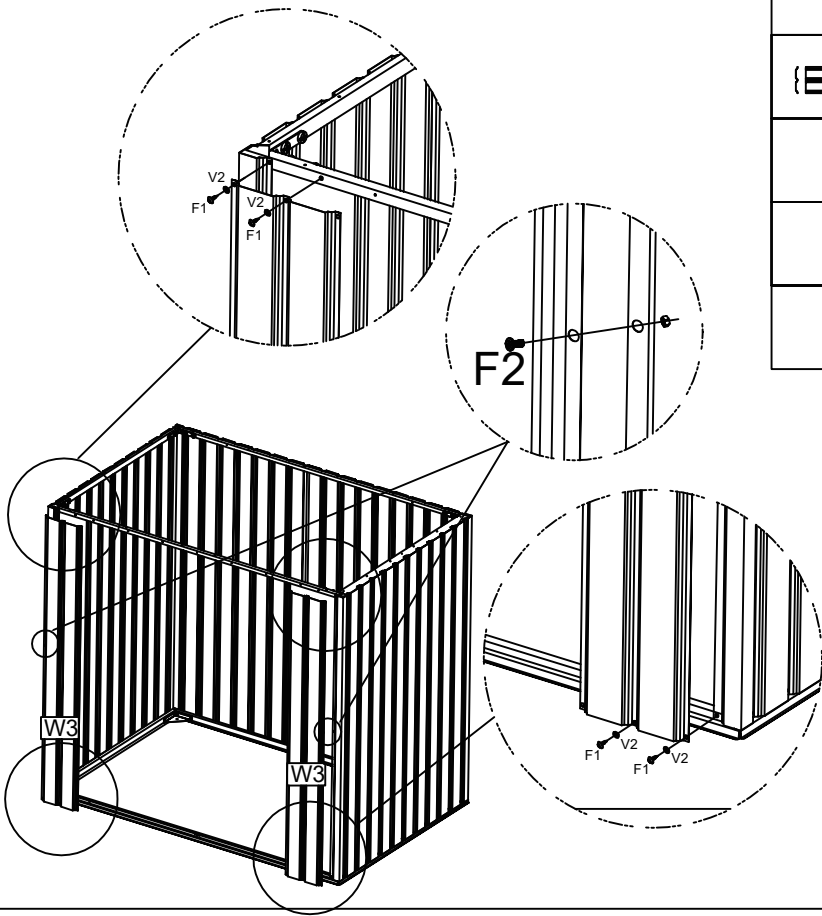





Directly covering the excess parts of the left and right panels.

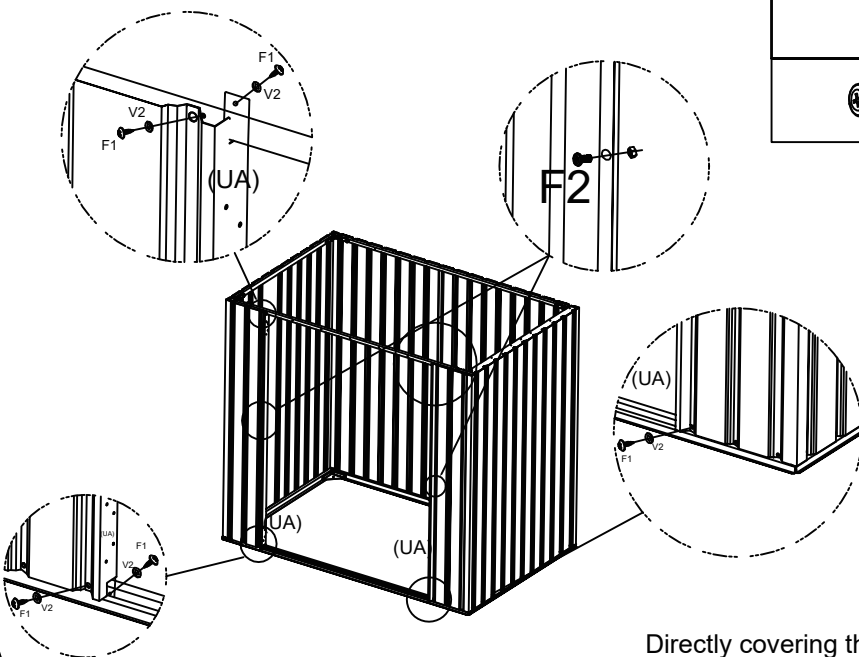
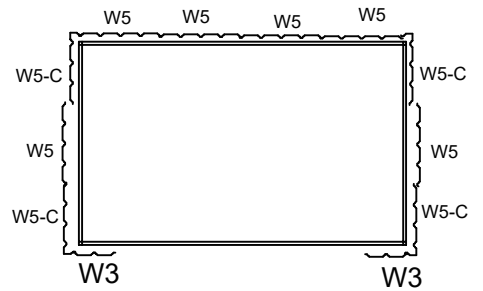

PART	NO.	QTY.
	W3	2
	V2	8
	F1	8
	F2	2





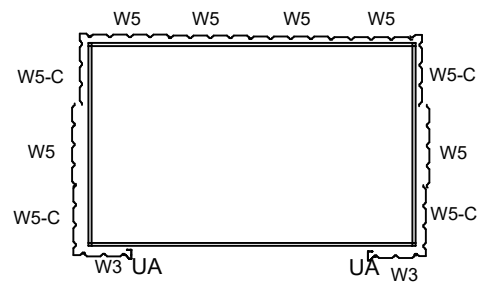

PART	NO.	QTY.
	UA	2
	V2	8
	F1	8
	F2	2





Directly covering the excess parts of the left and right panels.

Shed Top Frame Assemble

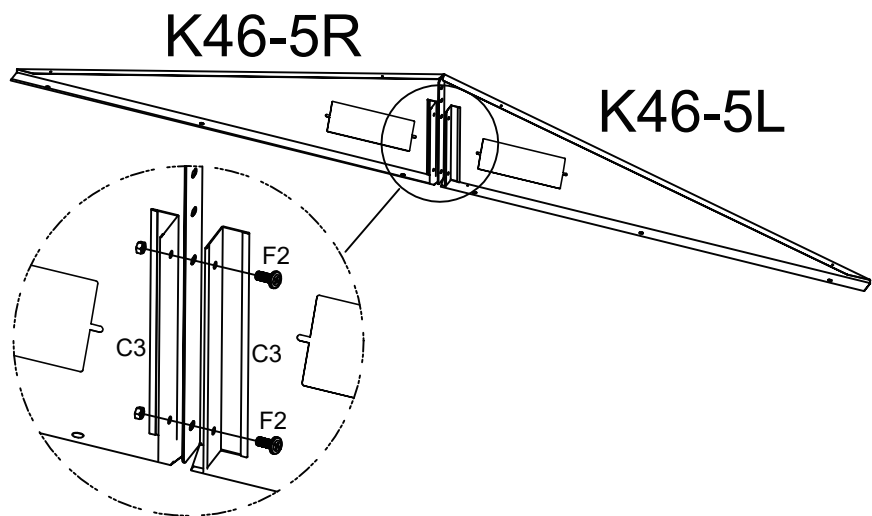
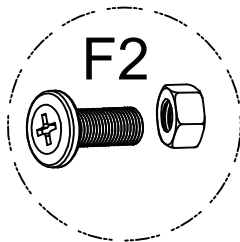
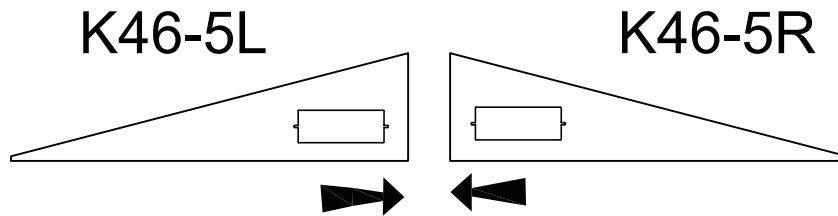

PART	NO.	QTY.
	K46-5L	2
	K46-5R	2
	C3	4
	F2	4

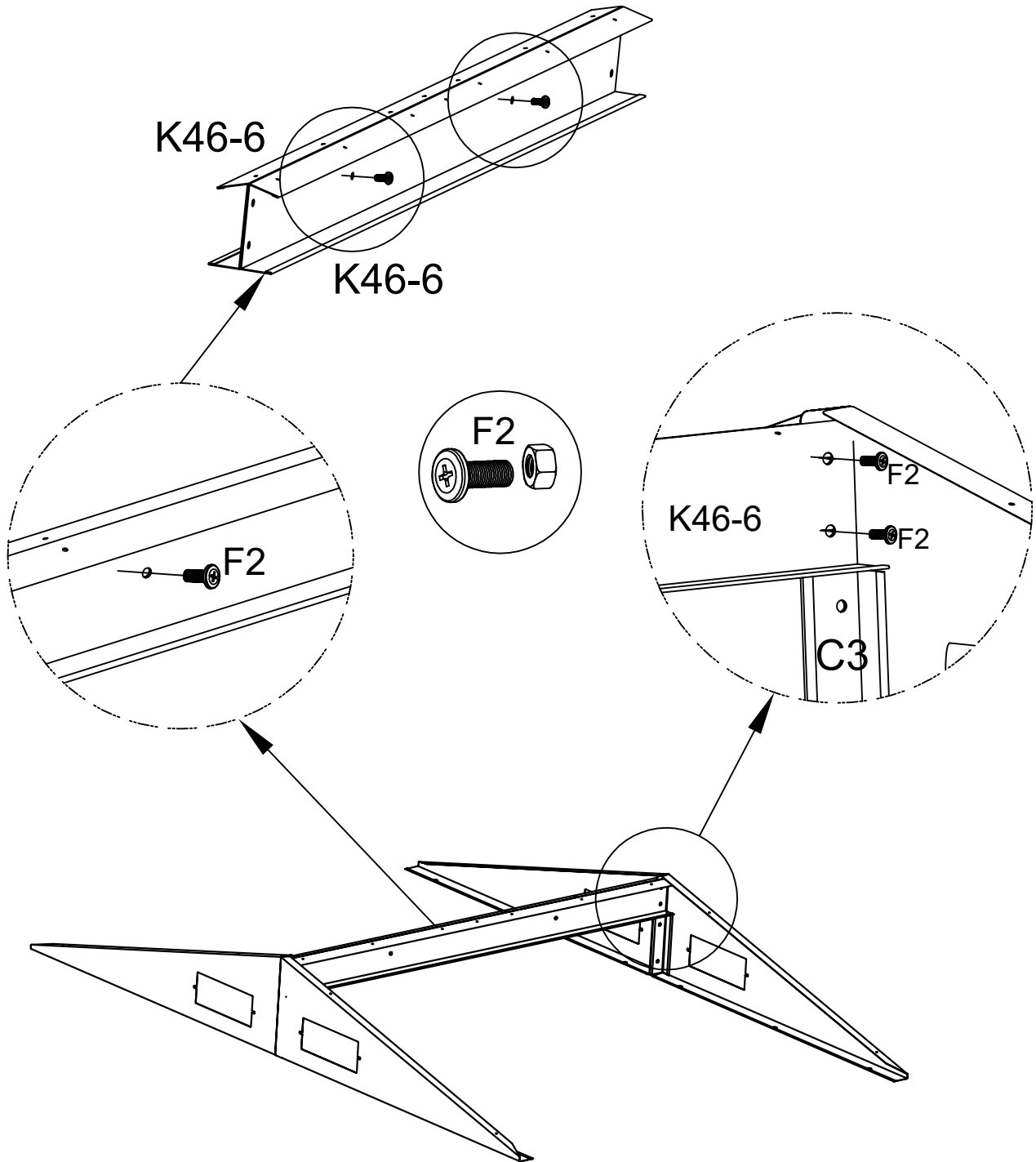

PART	NO.	QTY.
	K46-6	2
	F2	6



 Two Adults Are Required

PART	NO.	QTY.
	V2	12
	F1	12

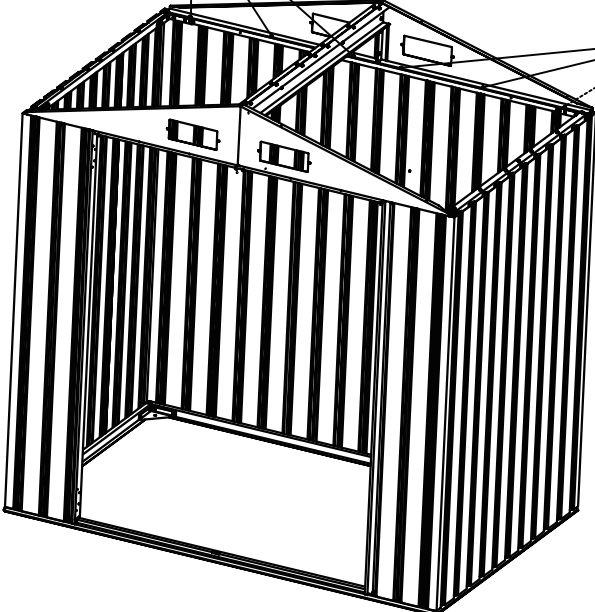
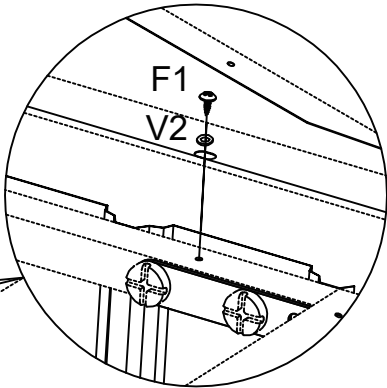
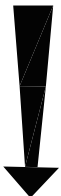
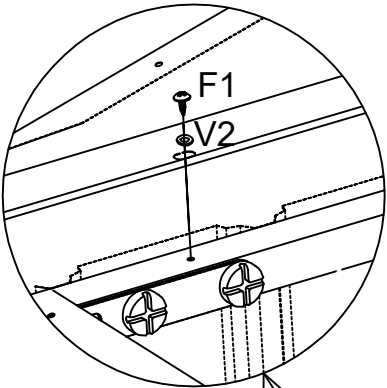
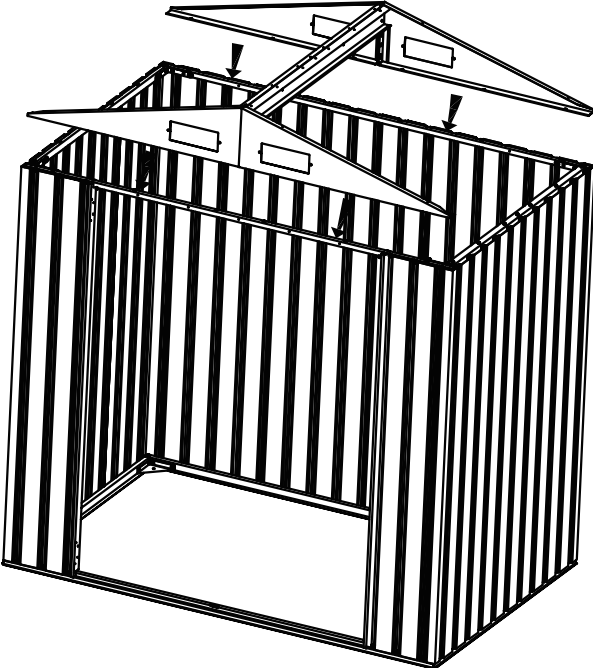

Shed Top Panels Assemble

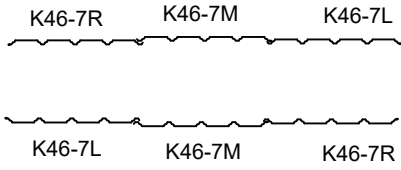



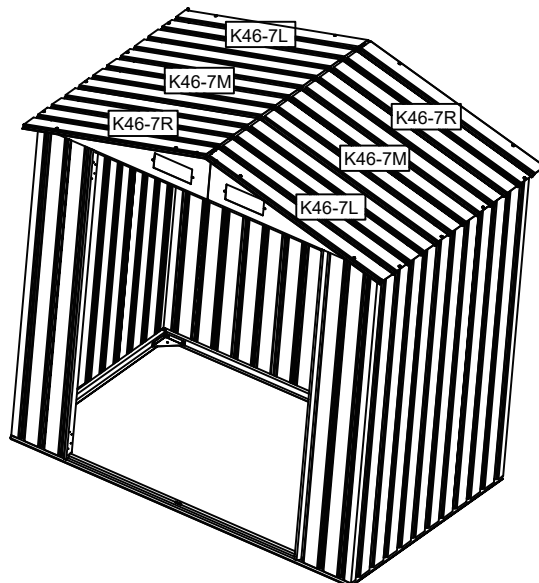
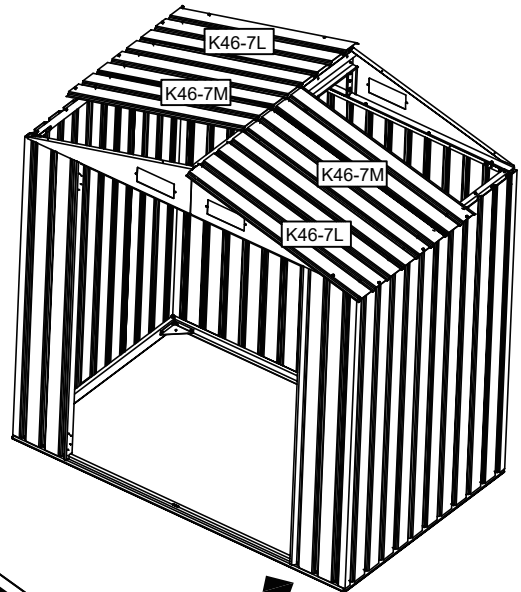
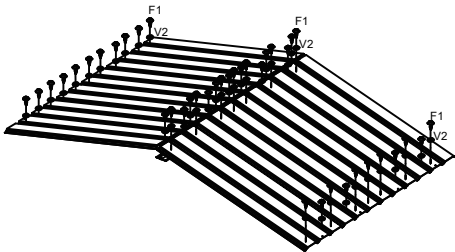
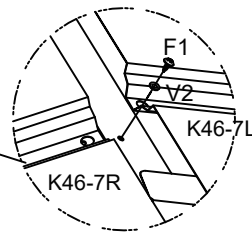
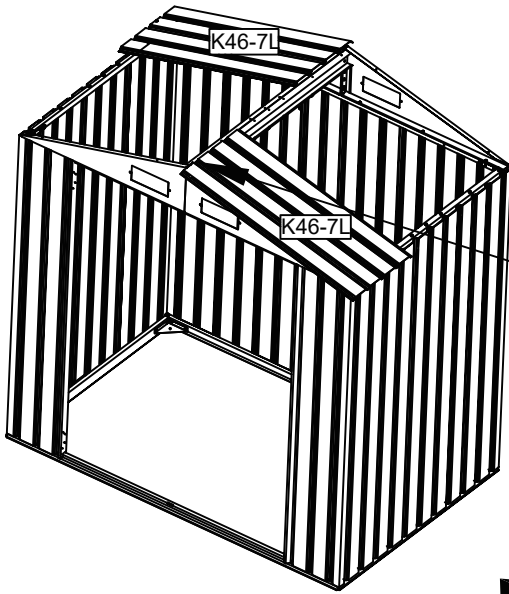



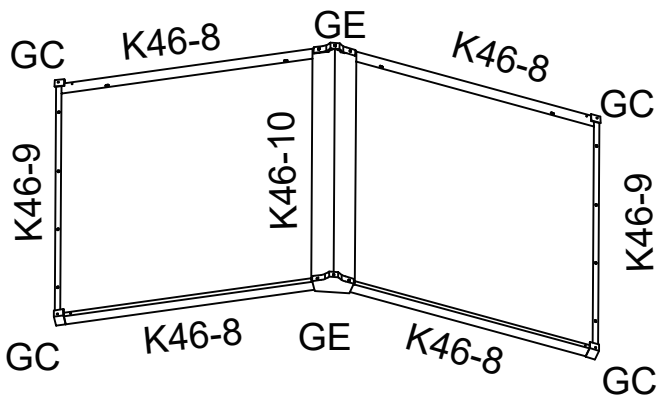

PART	NO.	QTY.
	K46-7L	2
	K46-7M	2
	K46-7R	2
	F1	44
	V2	44



Please steady the ladder make sure the product placed on a flat ground.





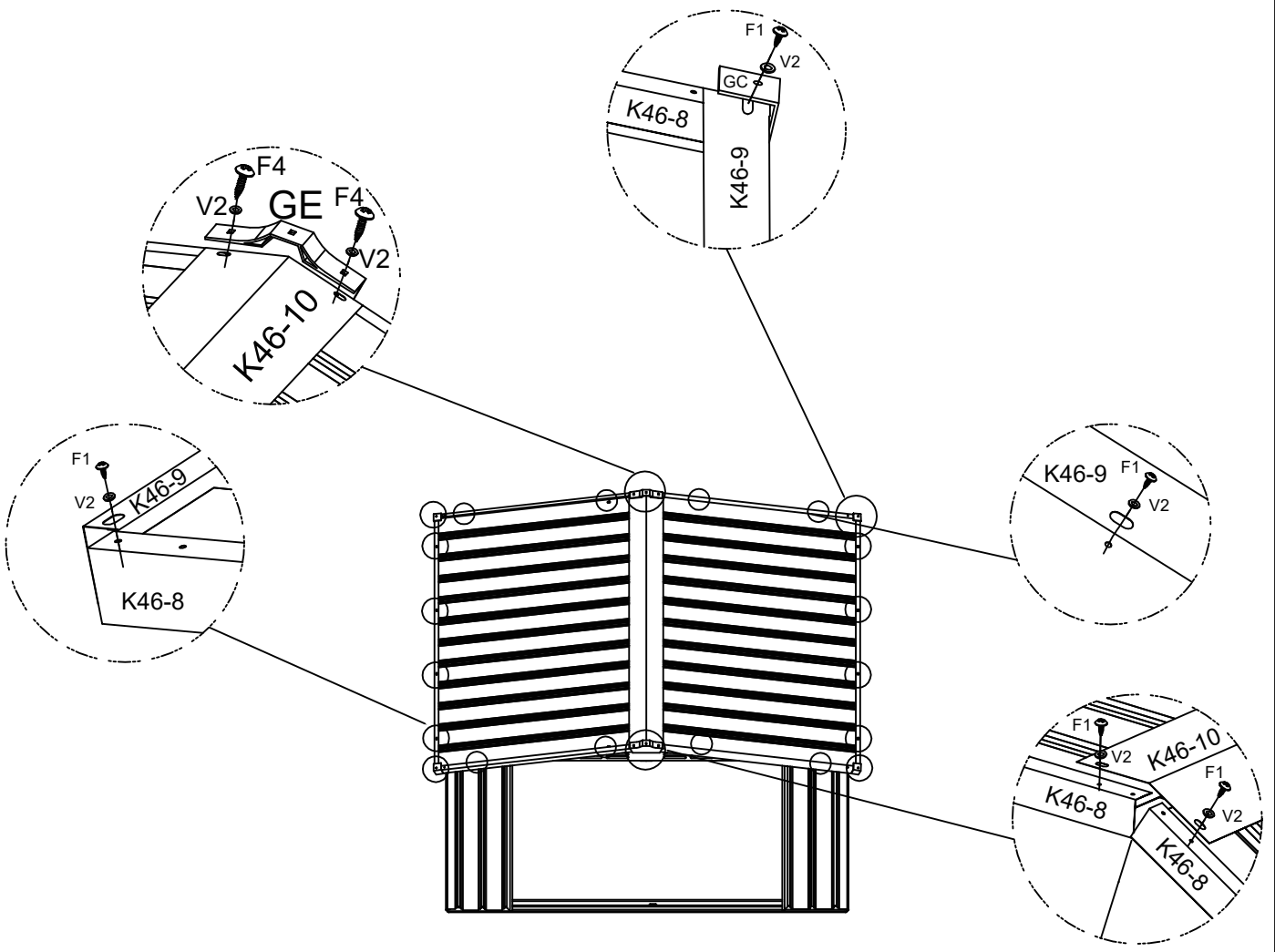



PART	NO.	QTY.
	K46-8	4
	K46-9	2
	K46-10	1
	GC	4
	GE	2
	F1	20
	V2	24
	F4	4



Door Assemble

DL

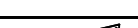
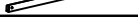
View from the front, the vertical rod covers the horizontal rod. The larger hole is always covered over the small hole.

PART	NO.	QTY.
	W5-K	1
	W2-HL	1
	DA	1
	DLA	1
	DDA	2
	DBA	2
	F1	9
	F2	4

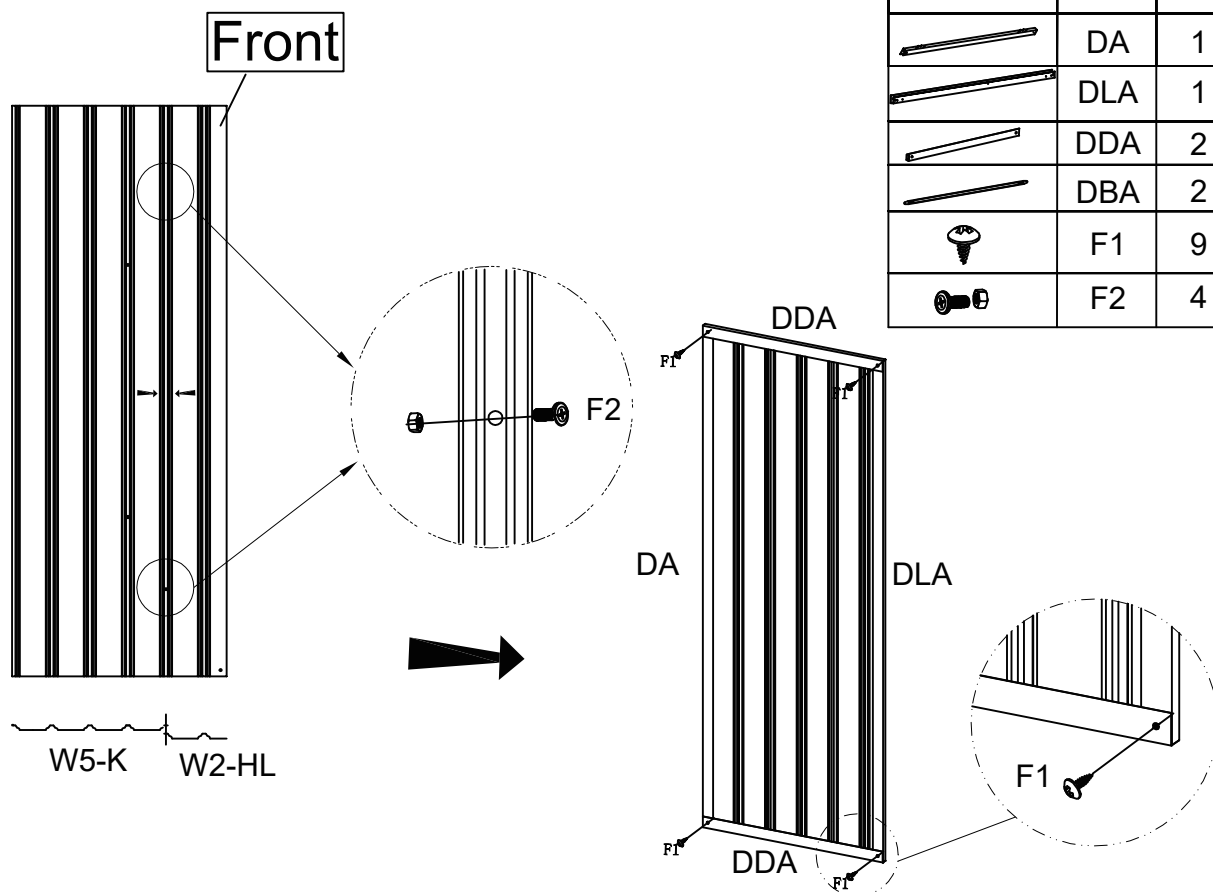



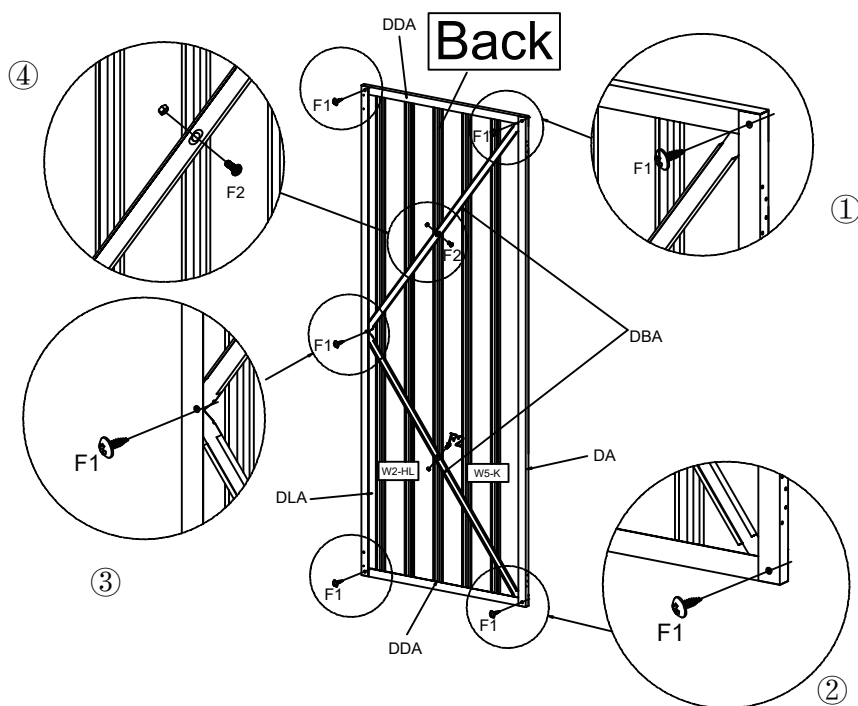



Please follow the steps ①-②-③-④ to install. The final fixation should be done after all parts are aligned.

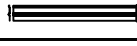

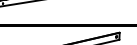
DR

View from the front, the vertical rod covers the horizontal rod.
The larger hole is always covered over the small hole.

PART	NO.	QTY.
	W5-K	1
	W2-HR	1
	DA	1
	DRA	1
	DDA 2</td	
	DBA	2
	F1	9
	F2	4

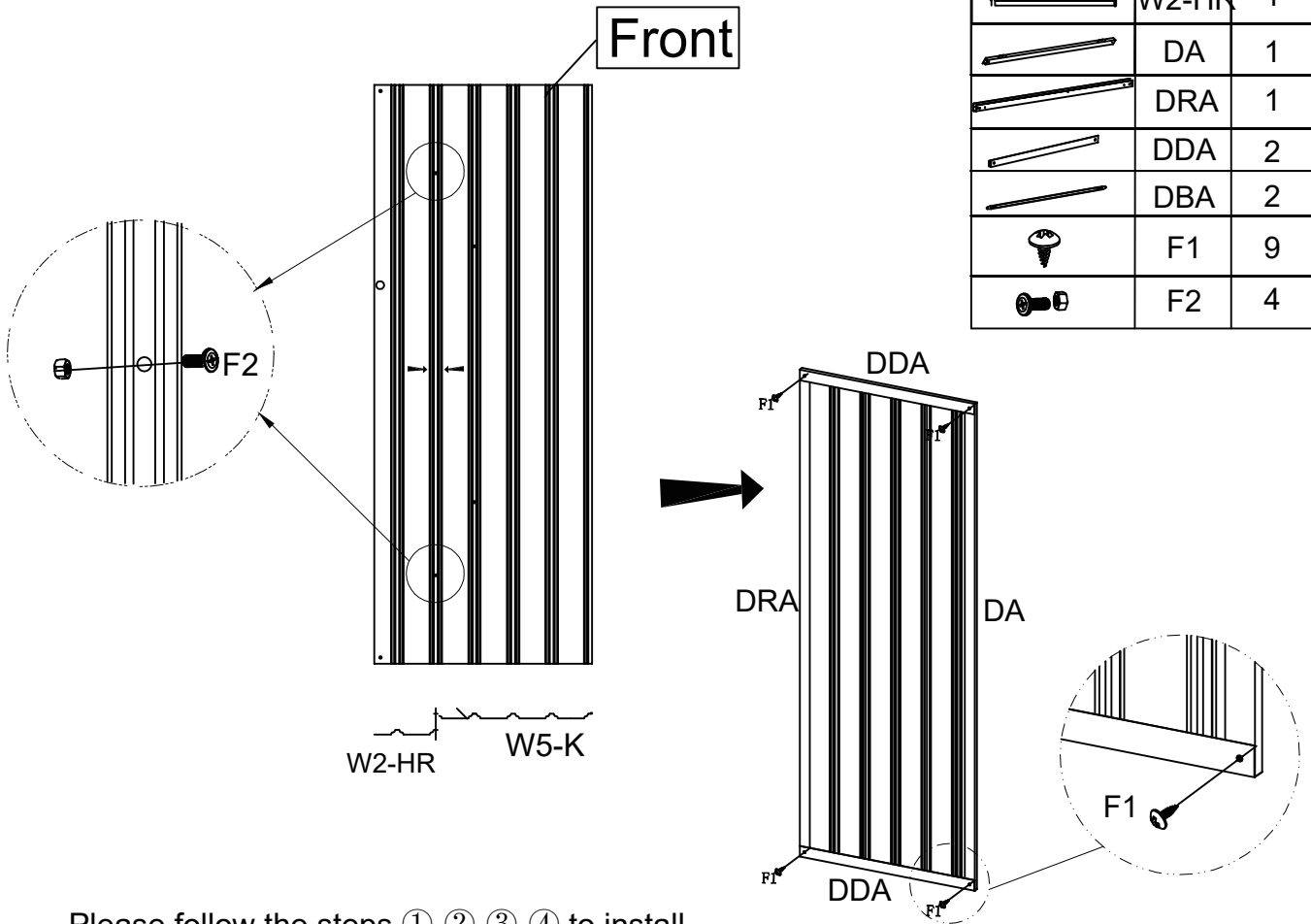



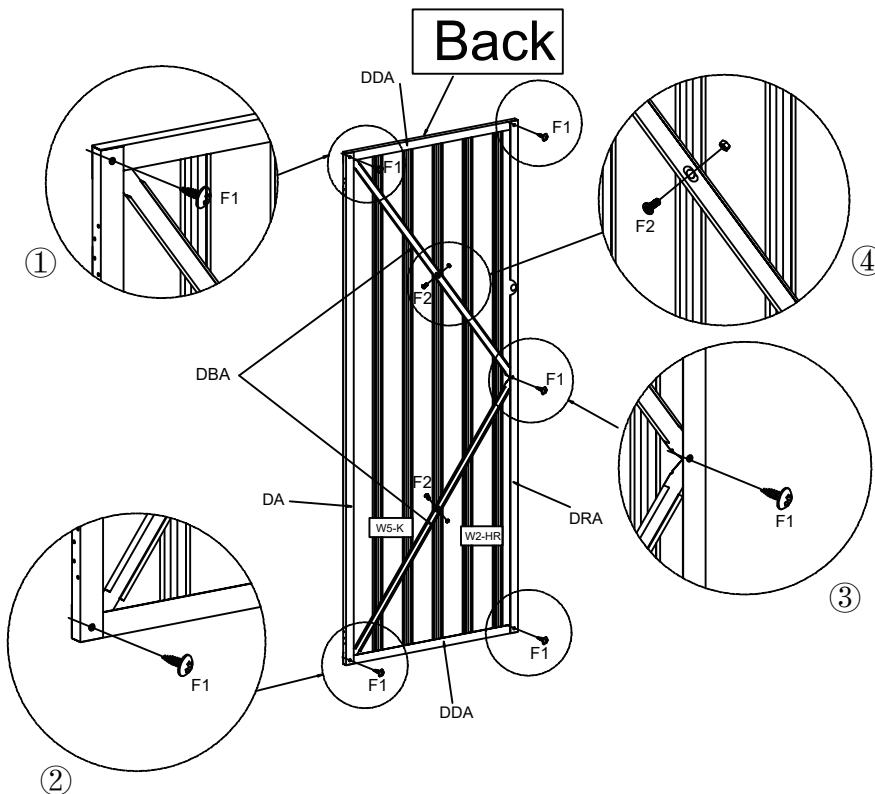





Please follow the steps ①-②-③-④ to install.
The final fixation should be done after all parts are aligned.



DL

The left and right is seen from the outside.

PART	NO.	QTY.
	DL	1
	DR	1
	DH	4
	DC	2
	F3	16
	GL	1
	F1	4
	V2	4

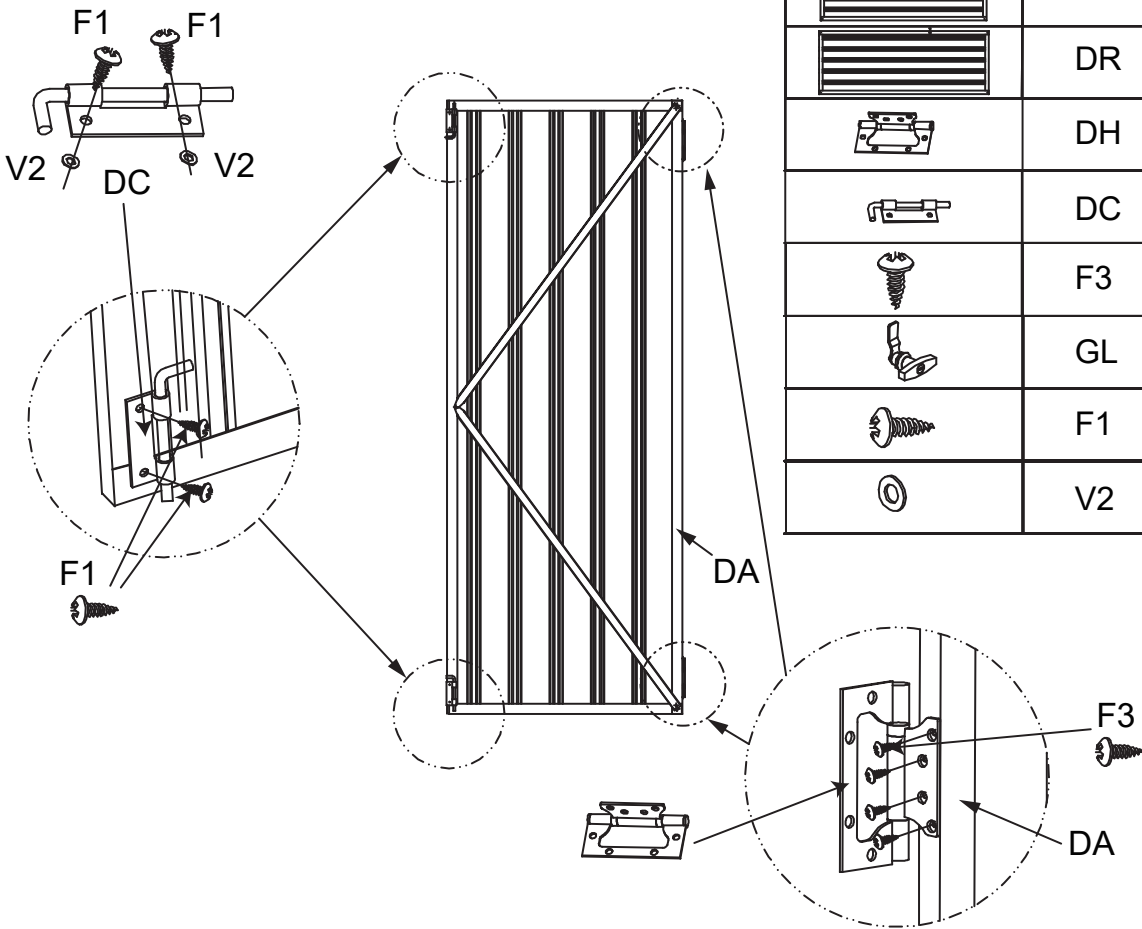

DR

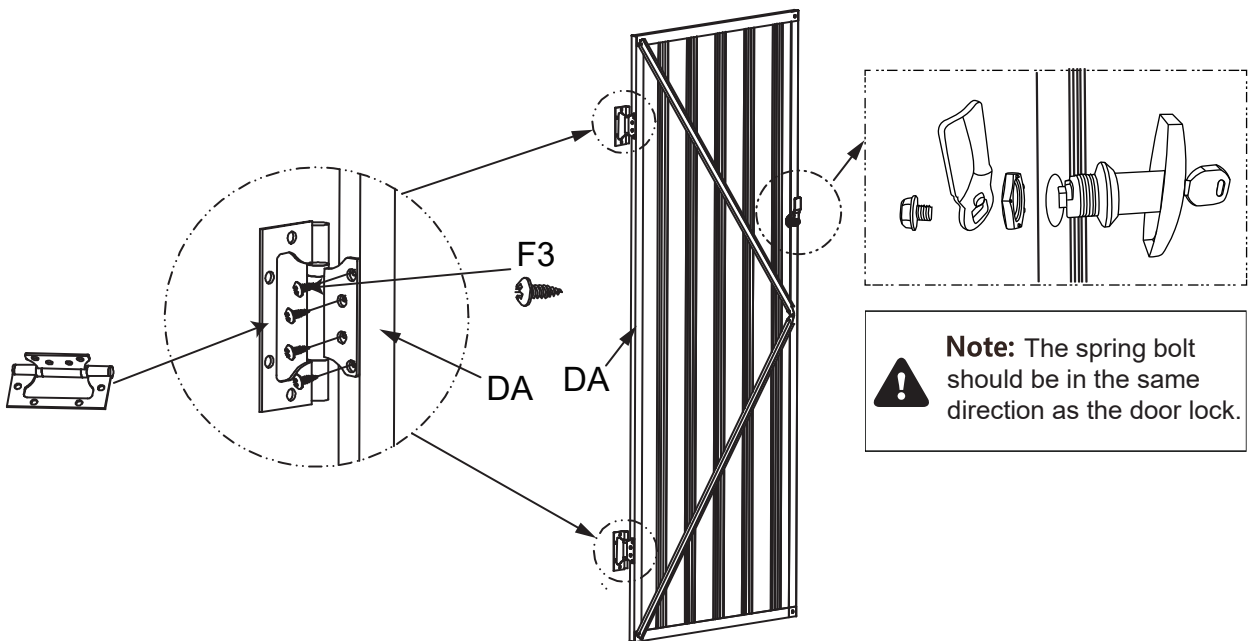

Note: The spring bolt should be in the same direction as the door lock.

PART	NO.	QTY.
	F3	16

The large piece needs to be installed on UA.(Wall side)

F3

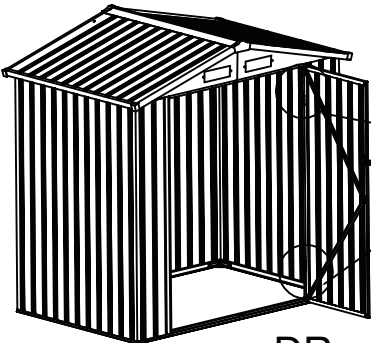

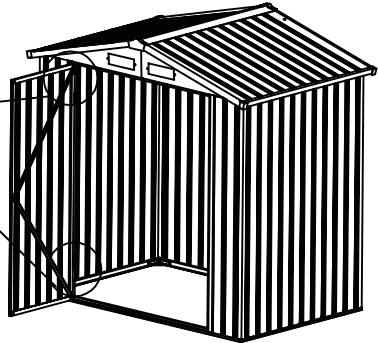
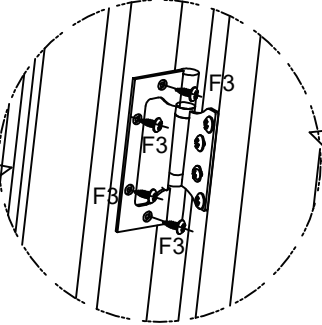

DR

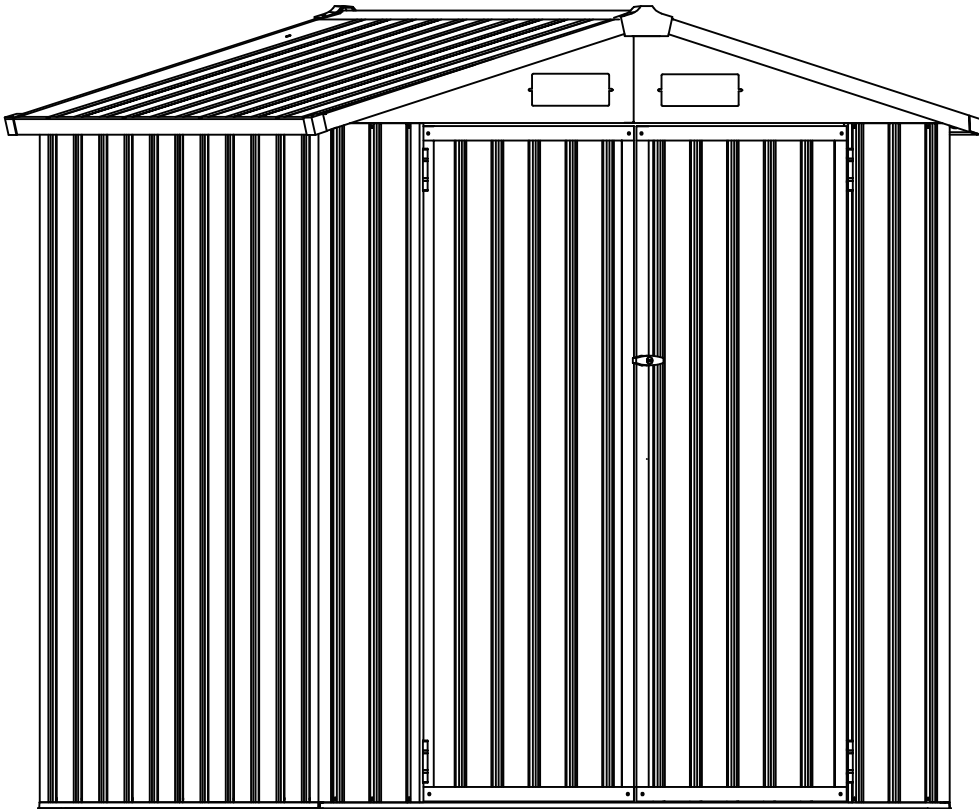

DL



PART	NO.	QTY.
	GF	4
	F2	8

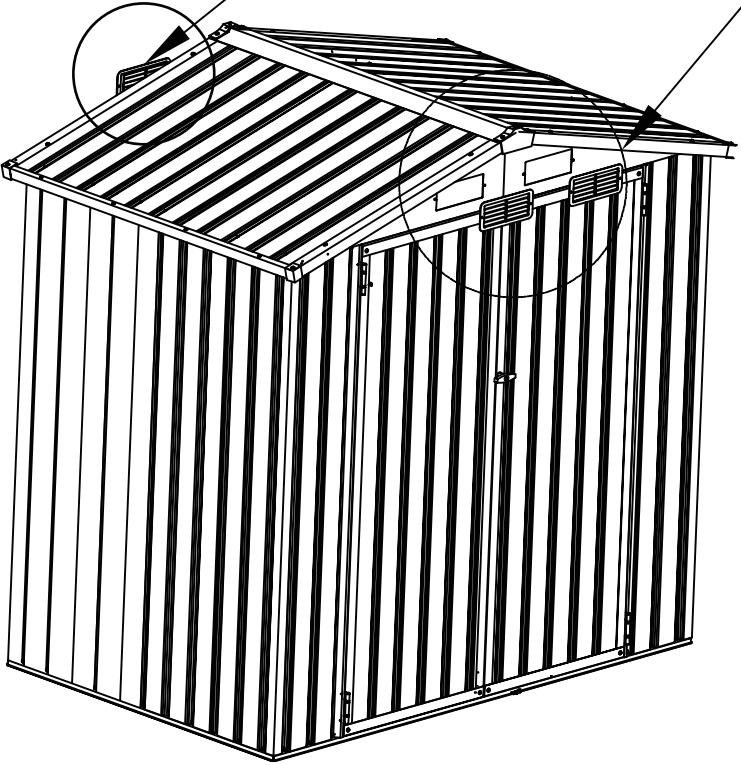
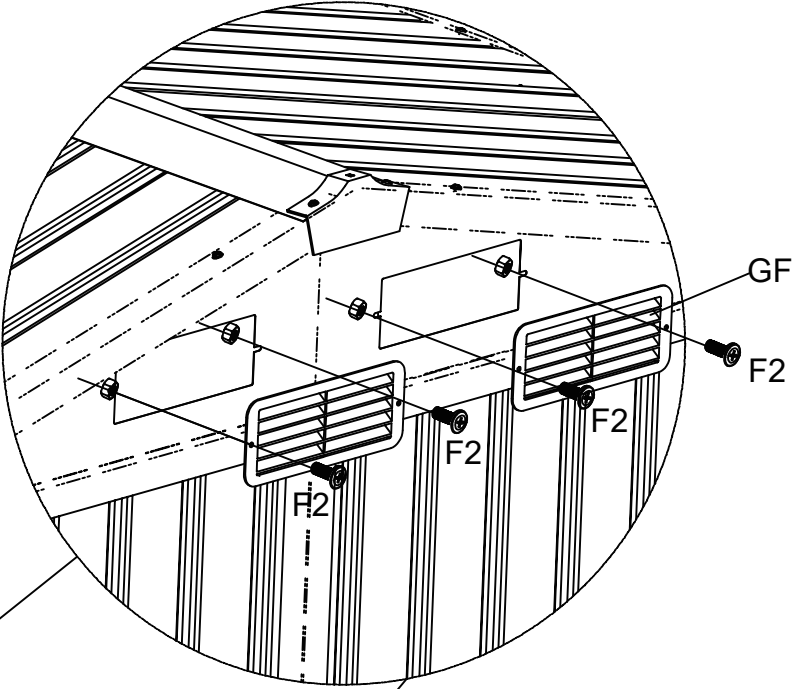

PART	NO.	QTY.
	SL	38

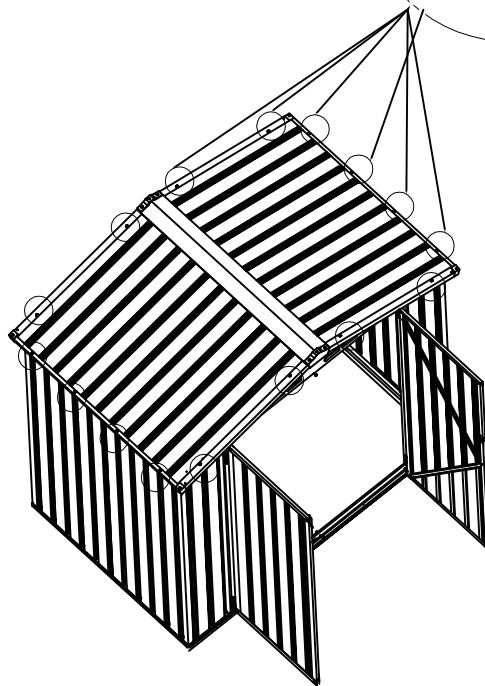
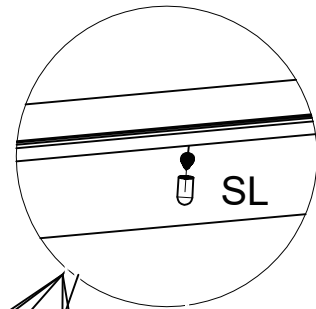
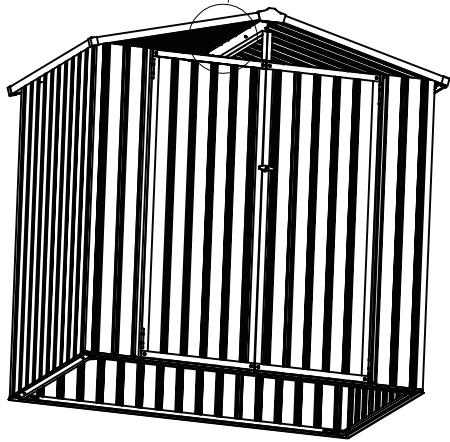
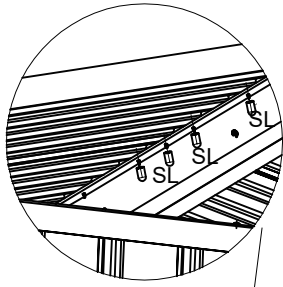

The exposed parts of the screw need to be covered with a plastic protective cap.
 Crew position: Upper beam support rod K46-8,K46-9.
 Upper beam K46-6.