

**MODEL: IG10600094-1012-WLY**

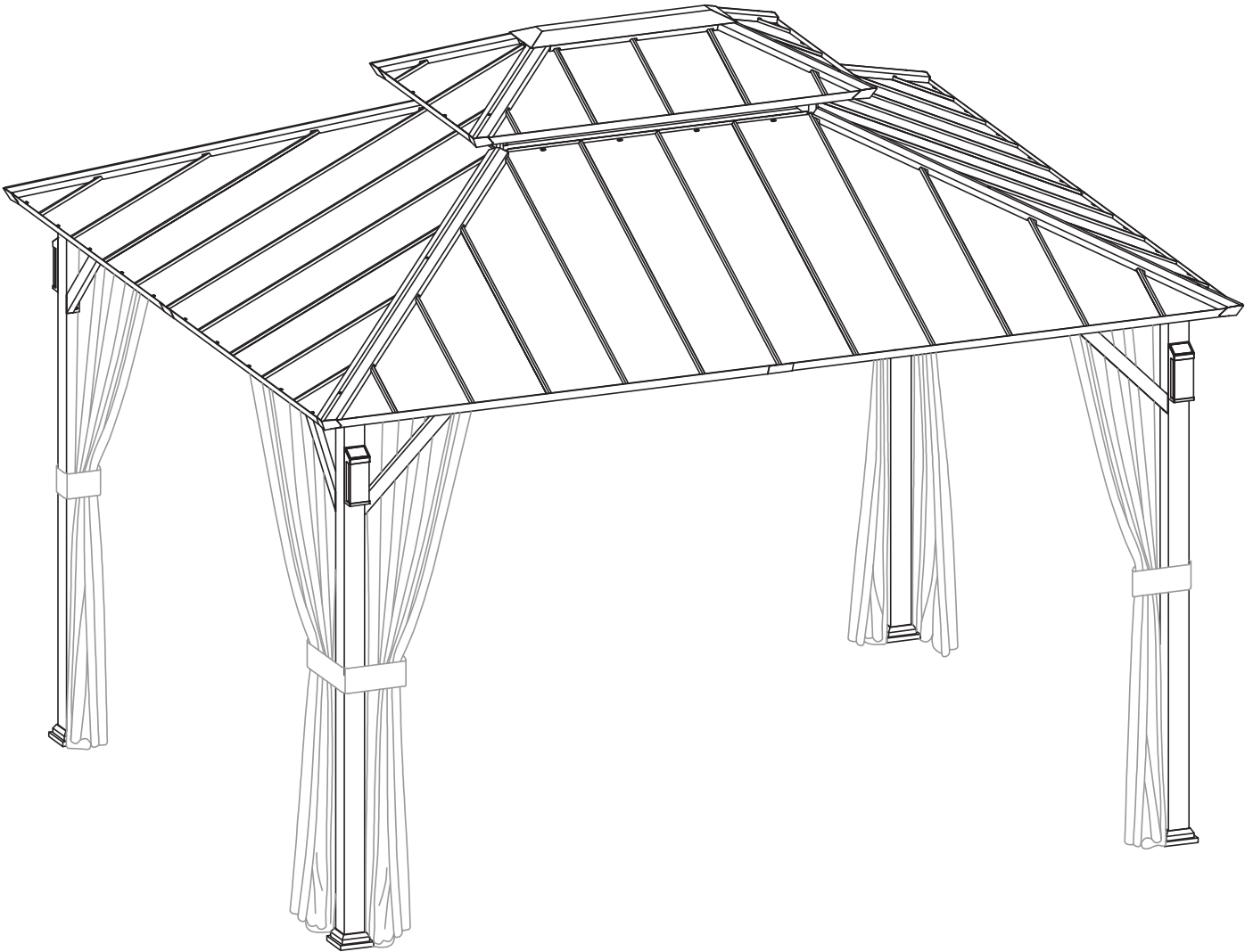

OWNER'S MANUAL

## The Horizon 10'x12' Hard Top Gazebo W/ Solar LED light

### TABLE OF CONTENTS

ASSEMBLY GUIDE.....	02
USING YOUR PRODUCT.....	04

October 13, 2024

### QUESTIONS?



E-mail: [support@modernshade.org](mailto:support@modernshade.org)













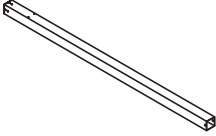
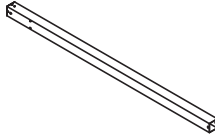
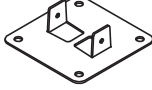
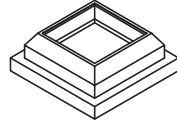
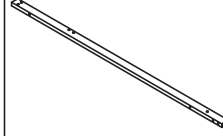
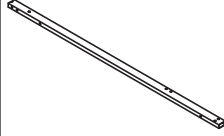
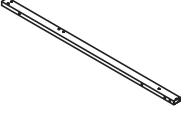
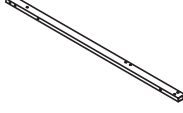

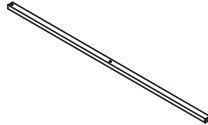
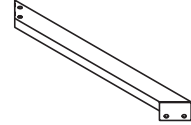
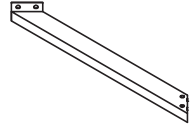

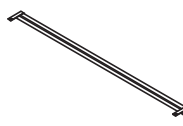
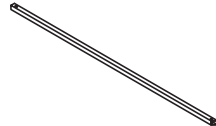
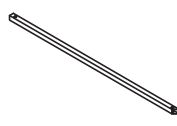
Toll Free: 1-888-666-3070

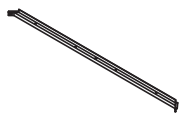

Mon-Fri: 9:00 ---17:00 PST.

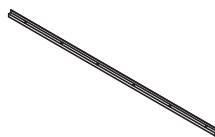
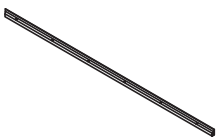
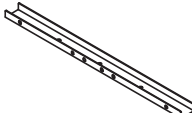
# ASSEMBLY GUIDE

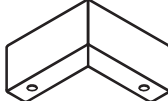
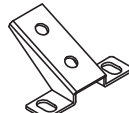
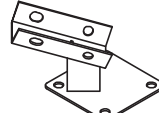
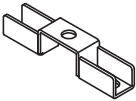
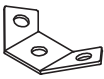
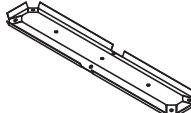
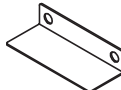
## PARTS LIST

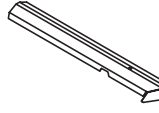
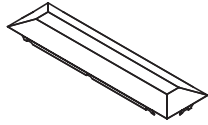
<b>A1</b> Post 1 (2 pieces) 	<b>A2</b> Post 2 (2 pieces) 	<b>B</b> Foot Base (4 pieces) 	<b>C</b> Foot Cover (4 pieces) 	<b>D1</b> Cross Beam 1 (2 pieces) 	<b>D2</b> Cross Beam 2 (2 pieces) 
P0010000102	P0010000202	P0030000101	P0020000101	P0040000102	P0040000202
<b>D3</b> Cross Beam 3 (2 pieces) 	<b>D4</b> Cross Beam 4 (2 pieces) 	<b>E</b> Roof Rib (4 pieces) 	<b>F1</b> Middle Cross Beam (4 pieces) 	<b>G1</b> Support Bracket 1 (4 pieces) 	<b>G2</b> Support Bracket 2 (4 pieces) 
P0040000502	P0040000602	P0070000101	P0080000101	P0050000102	P0050000202
<b>H3</b> Mosquito Net Rod 1 (4 pieces) 	<b>H4</b> Mosquito Net Rod 2 (4 pieces) 	<b>J1</b> Top Beam 1 (4 pieces) 	<b>J2</b> Top Beam 2 (4 pieces) 	<b>K4</b> Roof Support 1 (2 pieces) 	<b>K5</b> Roof Support 2 (2 pieces) 
P0100000401	P0100000501	P0090000101	P0090000201	P0090000901	P0090001001
<b>K8</b> Roof Support 3 (2 pieces) 	<b>K9</b> Roof Support 4 (2 pieces) 	<b>K10</b> Roof Support 5 (2 pieces) 	<b>K11</b> Roof Support 6 (2 pieces) 	<b>K12</b> Roof Support 7 (2 pieces) 	<b>K13</b> Roof Support 8 (2 pieces) 
P0090001301	P0090001401	P0090001501	P0090001601	P0090001701	P0090001801
<b>L1</b> Connector 1 (4 pieces) 	<b>L2</b> Connector 2 (4 pieces) 	<b>L3</b> Connector 3 (4 pieces) 	<b>L4</b> Connector 4 (4 pieces) 	<b>L5</b> Connector 5 (4 pieces) 	<b>L6</b> Connector 6 (8 pieces) 
P0060000101	P0110000102	P0110000302	P0060000301	P0060000401	P0060000501
<b>L7</b> Connector 7 (12 pieces) 	<b>L8</b> Connector 8 (1 piece) 	<b>L9</b> Connector 9 (4 pieces) 	<b>M1</b> Roof Rib Cover 1 (4 pieces) 	<b>M2</b> Roof Rib Cover 2 (4 pieces) 	<b>M3</b> Roof Rib Cover 3 (1 piece) 
P0060000601	P0060000701	P0110000501	P0120000101	P0120000201	P0120000501

# ASSEMBLY INSTRUCTIONS

•Please carefully unpack each of the components and hardware. check the components against the parts list and make sure there are no missing parts. lay pieces on cardboard or a soft mat to help protect the pieces from scratches.

## CAUTION

Watch for sharp edges when handling the pieces, wear gloves to avoid injury.

**STEP 01** Slide Foot Cover **C** onto Post 1 **A1**. Attach Foot Base **B** using two (2) M6\*20 Bolts **AA** and two (2) M6 Flat Washers **DD**. Repeat for the second Post 1 **A1**. Slide Foot Cover **C** onto Post 2 **A2**. Attach Foot Base **B** using two (2) M6\*20 Bolts **AA** and two M6 Flat Washers **DD**. Repeat for the second Post 2 **A2**.

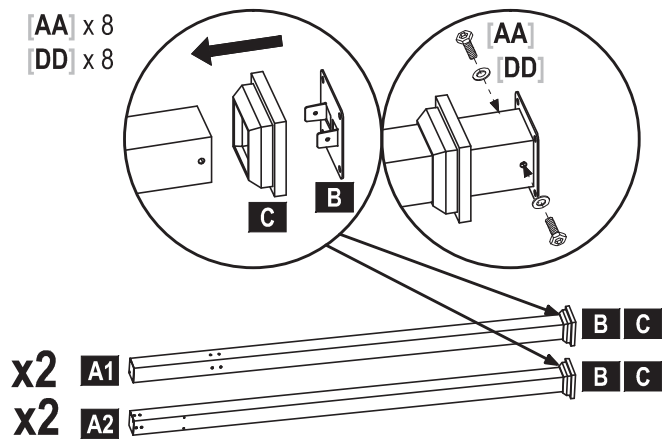

**STEP 03** Slide Cross Beam 3 **D3** and Cross Beam 4 **D4** onto the ends of Connector 1 **L1**, then place one (1) Connector 2 **L2** over the middle Connector 1 **L1**. Connect together using five (5) M6\*20 Bolts **AA** and five (5) M6 Flat Washers **DD**. Repeat to create a second assembly.

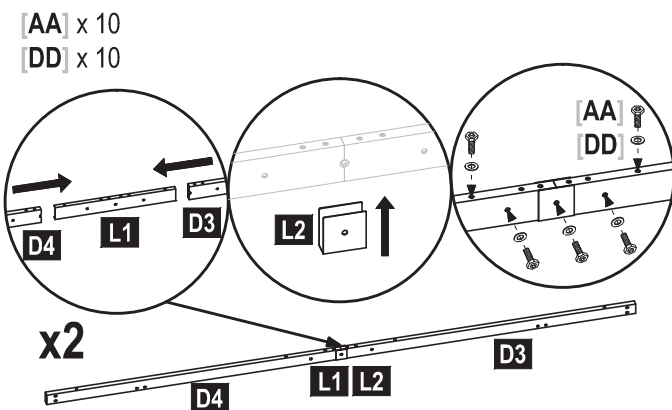

- For ease of assembly, it is recommended to have 3 or more people and allow enough time to completely finish the assembly. assembly can take 6-8 hours. a step-ladder is required for assembly (not included).
- Follow step by step instructions, and follow all safety warnings provided with your tools.
- DO NOT tighten screws until all the screws and washers are properly installed. tighten screws securely, do not over tighten.
- Gazebo should not be used in inclement weather and high winds.

**STEP 02** Slide Cross Beam 1 **D1** and Cross Beam 2 **D2** onto the ends of Connector 1 **L1**, then place one (1) Connector 2 **L2** over the middle Connector 1 **L1**. Connect together using five (5) M6\*20 Bolts **AA** and five (5) M6 Flat Washers **DD**. Repeat to create a second assembly.

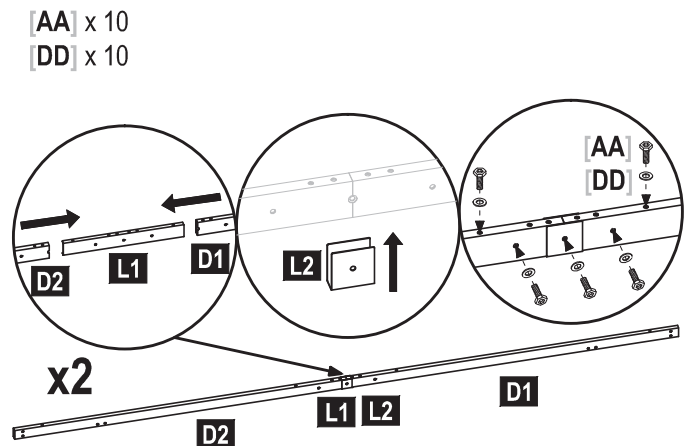

**STEP 04** Connect the assembly from Step 2 **D1** + **D2** to Post 1 **A1** and Post 2 **A2** using four (4) M6\*20 Bolts **AA** and four (4) M6 Flat Washers **DD**. Repeat to create a second set of legs.

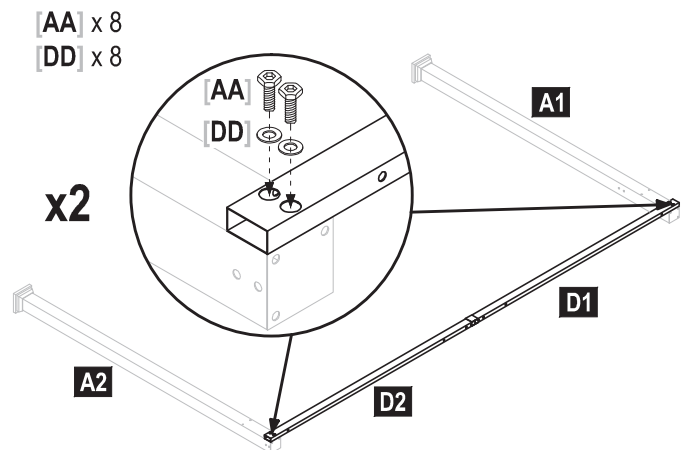

**STEP 05** Connect the sets of legs from Step 4 together using the assemblies from Step 3 **D3** + **D4** using eight (8) M6\*20 Bolts **[AA]** and eight (8) M6 Flat Washers **[DD]**.

**[AA]** x 8  
**[DD]** x 8

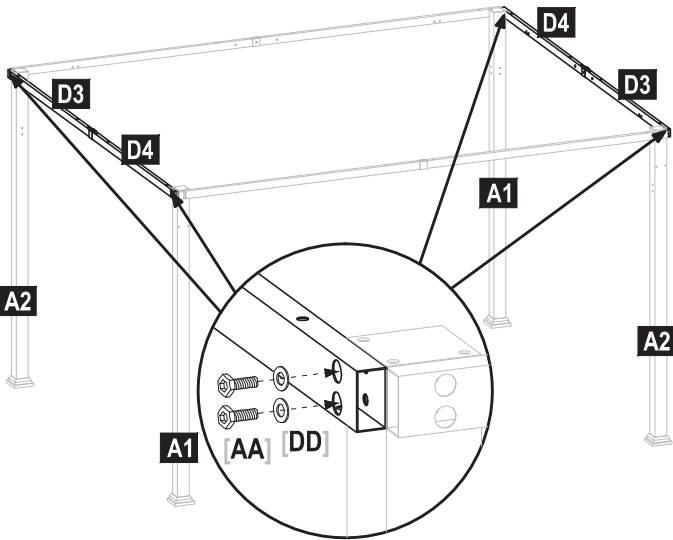

**STEP 06** In each corner, connect one Connector 3 **L3** using two (2) M6\*20 Bolts **[AA]** and two (2) M6 Flat Washers **[DD]**. Then, connect one Connector 5 **L5** on top of each corner using three (3) M6\*20 Bolts **[AA]** and three (3) M6 Flat Washers **[DD]**.

**[AA]** x 20  
**[DD]** x 20

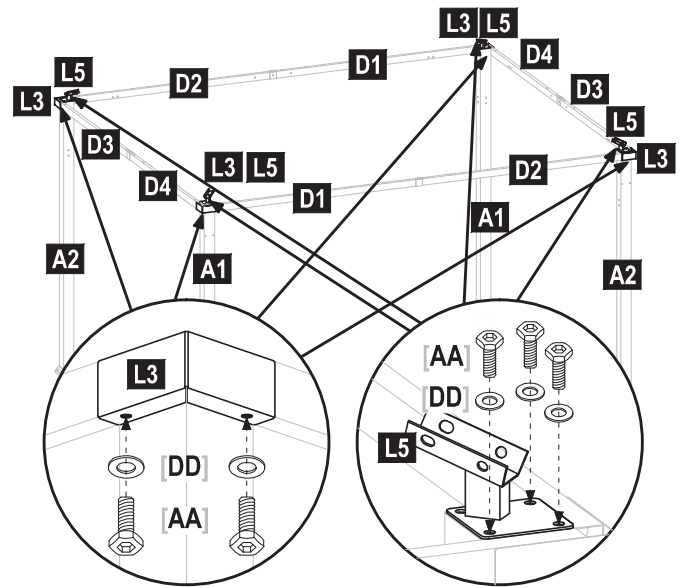

**STEP 07** On each post, attach one (1) Support Bracket 1 **G1** on the left and one (1) Support Bracket 2 **G2** on the right using two (2) M6\*20 Bolts **[AA]** and two (2) M6 Flat Washers **[DD]** on the lower holes and two (2) M6\*45 Bolts **[BB]** and two (2) M6 Flat Washers **[DD]** in the upper holes.

**[AA]** x 16  
**[BB]** x 16  
**[DD]** x 32

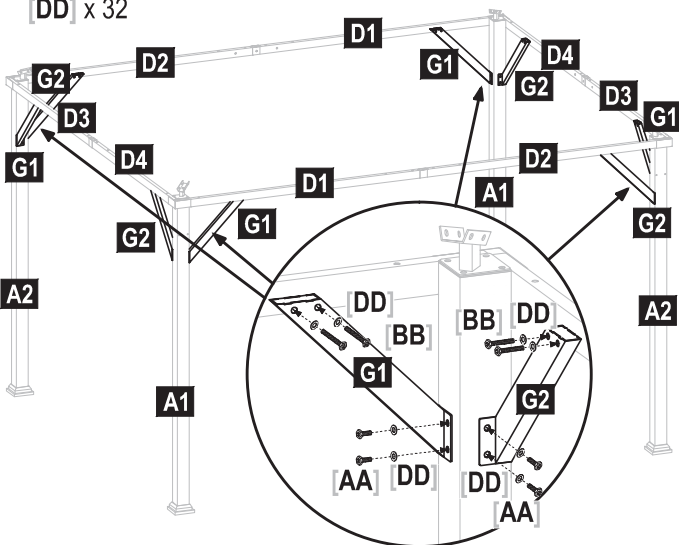

**STEP 08** Attach two Mosquito Net Rods 3 **H3** on each long side of the gazebo and two (2) Mosquito Net Rod 4 **H4** on the short sides of the gazebo, using two (2) M6\*20 Bolts **[AA]** and two (2) M6 Flat Washers **[DD]** each.

**[AA]** x 16  
**[DD]** x 16

