

NOTICE

- * Please make sure that you have all parts indicated and they are in good condition before you begin assembly of this item. Refer to part list and hardware list below for guidance.
- * This item should be assembled on a soft surface to prevent scratching the finish during assembly.
- * This item may require periodic tightening.



PREPARATION

- * Before beginning assembly of product, make sure all parts are present. Compare parts with part contents list and hardware contents list.
- * If any part is missing or damaged, do not attempt to assemble the product.
- * Estimated Assembly Time: 15 minutes.
- * Tools Required for Assembly (included): Allen Key and Screw Driver (not included)
- * If you are having difficulty, our friendly Customer Care team is always here to help.

CARE AND MAINTENANCE

- * Please make sure that you have all parts indicated before you begin assembly of this item
- * This item should be assembled on a soft surface to prevent scratching the finish during assembly
- * This item may require periodic tightening

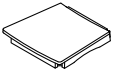
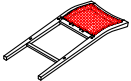
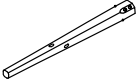
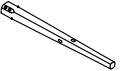
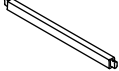
Part List and Hardware List

PIECE	DESCRIPTION	PICTURE	QUANTITY
A	Chair Seat		2X
B	Chair Back		2X
C	Front Leg-1		2X
D	Front Leg-2		2X
E	Front Rail		2X
F	Side Rail-1		2X
G	Side Rail-2		2X

FURNITURE

Product Dimensions: 18.9" W x 22.8" D x 42.1"H

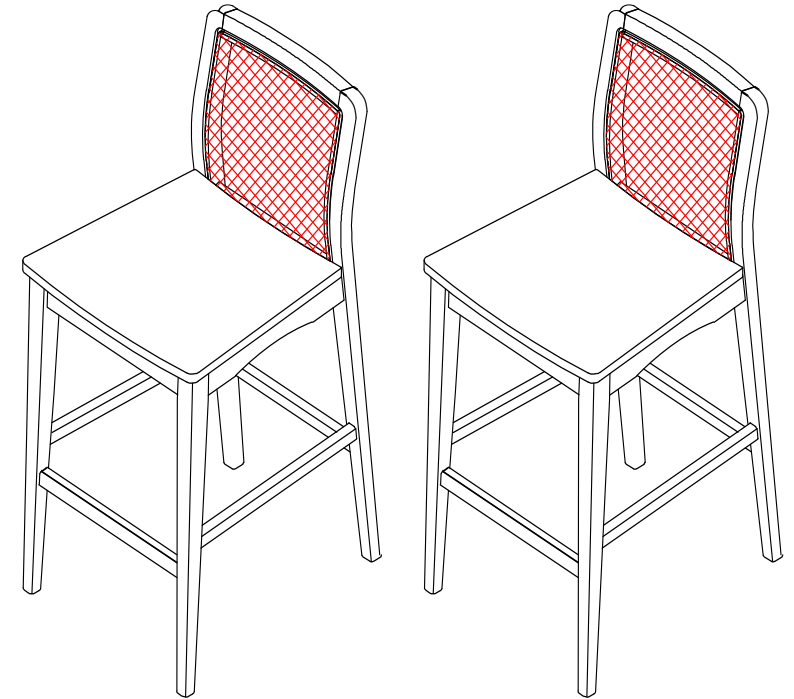





WARNING !







Weight capacity: 275 LBS

Warning: Do not stand on Chair

Warning: Do not over torque Bolts

PIECE	DESCRIPTION	PICTURE	QUANTITY
HW1	Socket bolts M6x1.0x80mm		8X
HW2	Socket bolts M6x1.0x60mm		8X
HW3	Socket bolts M6x1.0x35mm		4X
HW4	Phillips Screws 4x50mm		12X

PIECE	DESCRIPTION	PICTURE	QUANTITY
HW5	Split Lock Washer 6mm		20X
HW6	Flat Washer 6mm		20X
HW7	Wooden Dowel ϕ 10x30mm		4X
HW8	Allen Key		1X

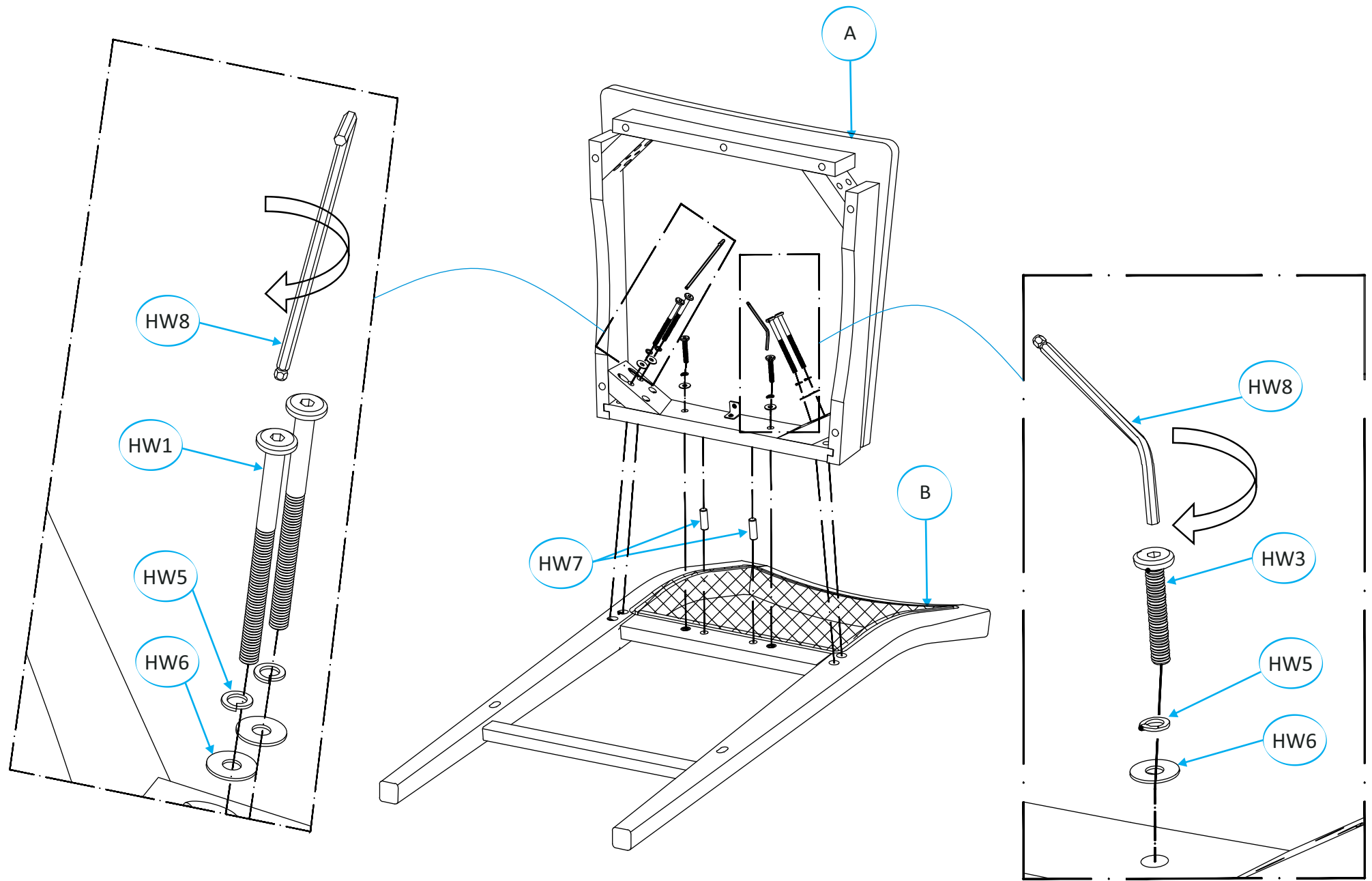

STEP 1: Attach the seat to the chair back. Make sure to apply all bolts into the holes properly before tightening.

