

ASSEMBLY AND INSTALLATION INSTRUCTIONS

WARNING: BE SURE TO SHUT OFF POWER AT THE MAIN FUSE OR CIRCUIT BREAKER BOX BEFORE INSTALLING OR SERVICING THIS FIXTURE.

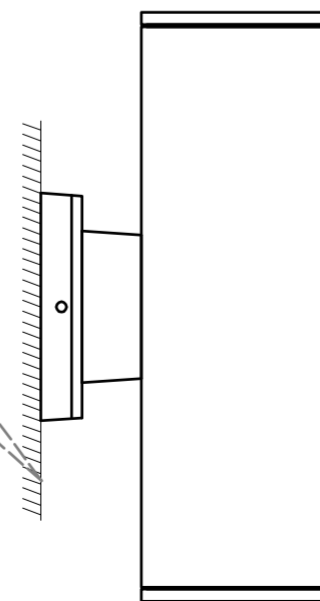
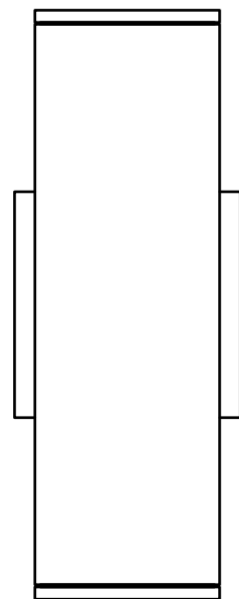
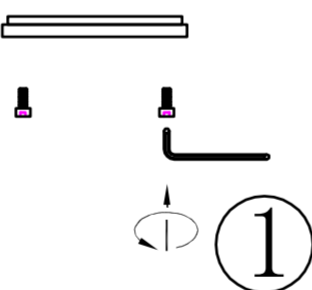
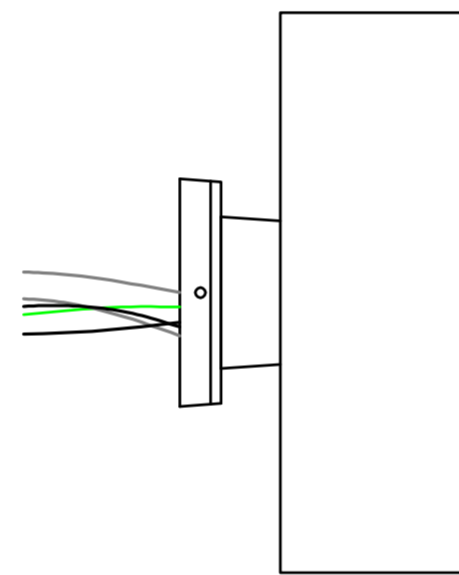
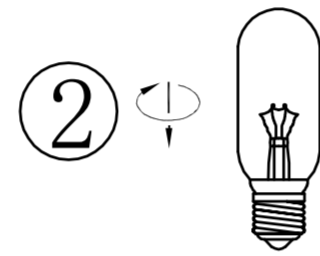
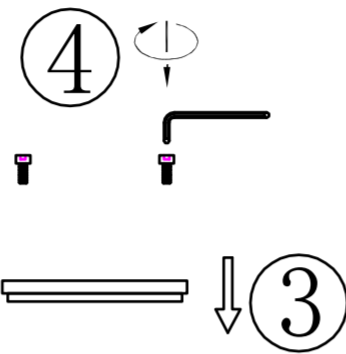
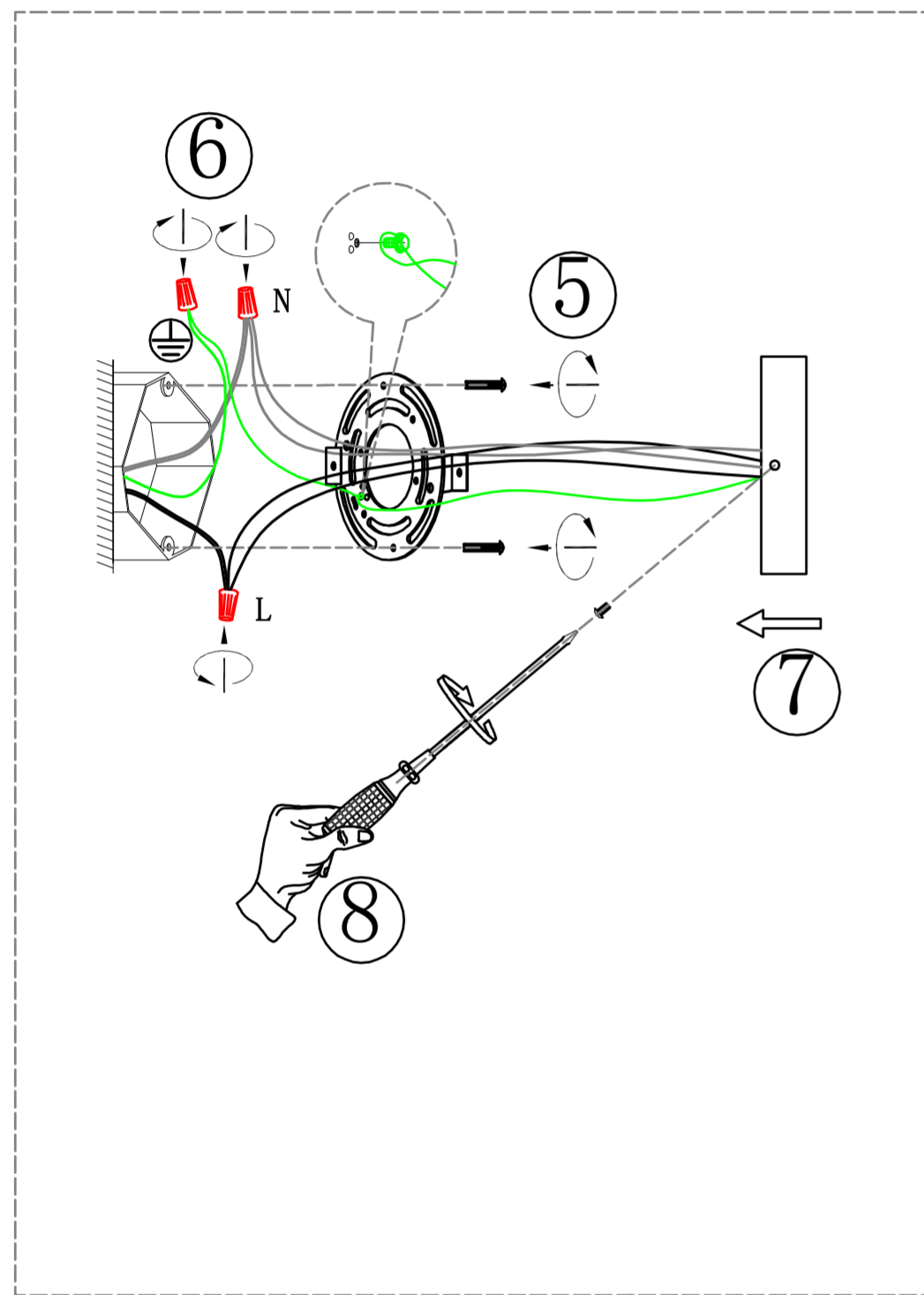

Installation Step

Turn off the power at fuse or circuit box

1. Loosen the screws on the light body, then carefully remove the cover of top and bottom.
2. Install the bulbs. (Bulb not included).
3. Put the covers back on the light body.
4. Insert the screws through the holes on the cover and tighten to secure.
5. Attach the mounting plate to the wall box by using two mounting screws.
6. Make wire connections with wire nuts:
---The black wire from light to the black wire from power source.---
The white wire from light to the white wire from power source.---
Attach the fixture grounding wire to the mounting plate with the green grounding screw. Then connect it to the house grounding wire with the wire nut.

Carefully tuck wires back into the wall box.

- 7-8. Attach the back plate to the mounting plate and tighten it with two ball nuts.

Turn on the power at fuse or circuit box