

3-Seat Sofa

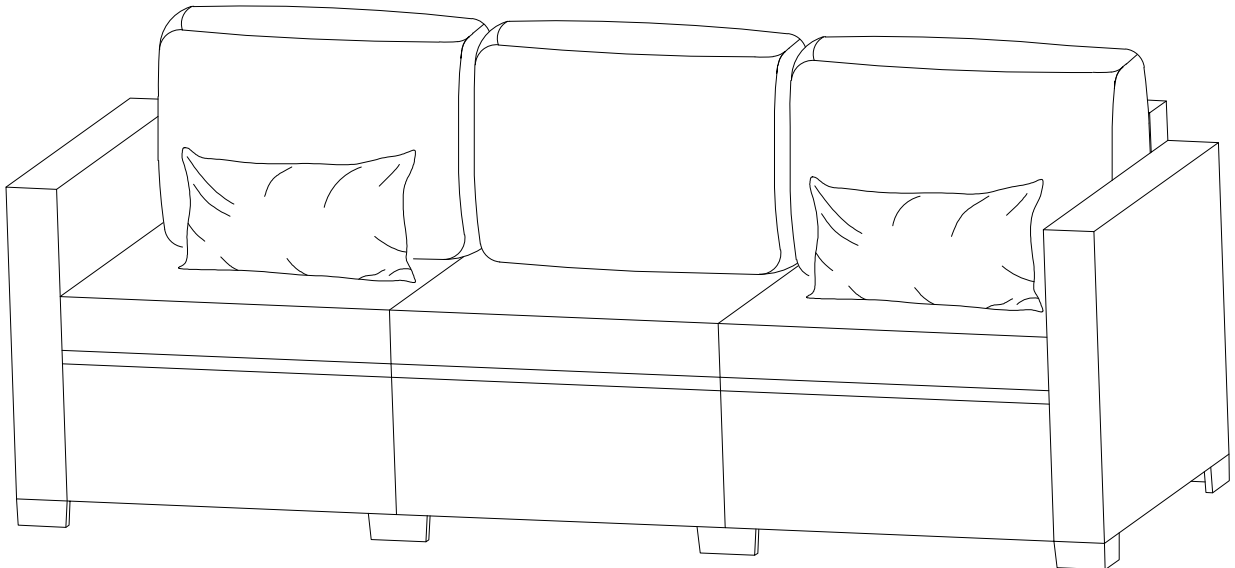

- a. Opening, please check the parts, any defect or missing, contact us in time.
- b. Cushion inserts and covers, furniture cover are usually placed in the gap in the armrest or backrest. Pay attention to check!
- c. Advisable to assemble on the mat to avoid wear and tear. Avoid all sharp objects touching the product surface. Do not allow the children to play around.
- d. Do not tighten all screws entirely until assemble is completed. Power tools are available, don't over-tighten for strip threads.
- e. If the cushion covers crease, maybe you can try soaking with warm water or ironing!
- f. Assembly video available, any problems assembling, contact us in time!

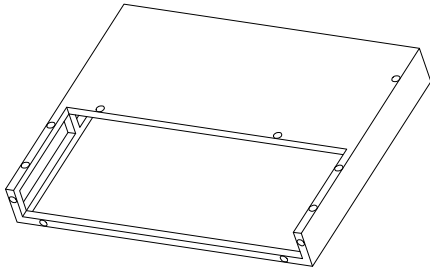

A: right sofa arm
1 pc

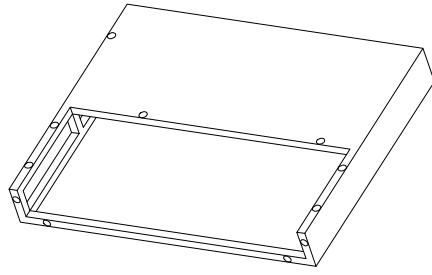

B: left sofa arm
1 pc

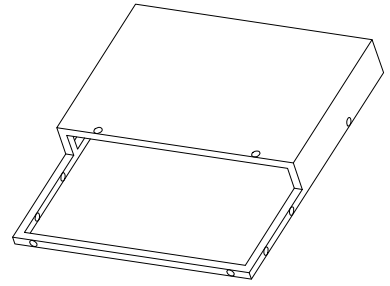

C: sofa back
3 pcs

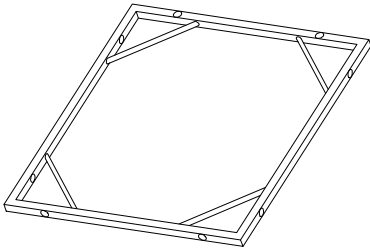

D: sofa seat board
3 pcs

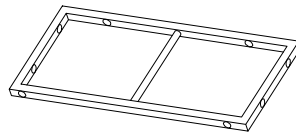

E: sofa front screen
3 pcs

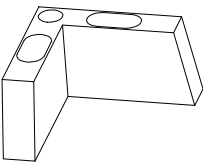

F: sofa foot
4 pcs

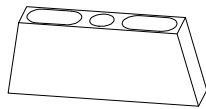

G: sofa foot
4 pcs

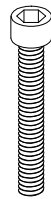

R: screw M6*35mm
6 pcs

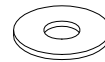

S: shim ø16*6.4*1
74 pcs



T: nut M6
34 pcs



U: brace bar
2 pcs

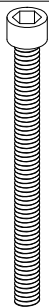

V: screw M6*60mm
14 pcs

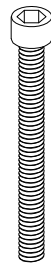

W: screw M6*50mm
20 pcs

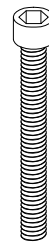

X: screw M6*45mm
16 pcs



Y: shim ø11*6.2*1
16 pcs

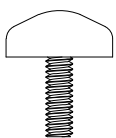

Z: adjustable screw
8 pcs

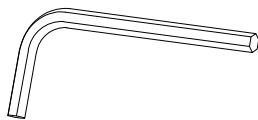

Inner hexagon spanner
1 pcs



open spanner
1 pcs

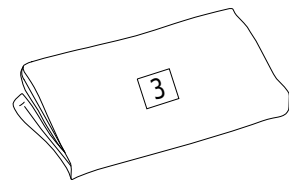

furniture cover for 3-seat sofa
1 pcs

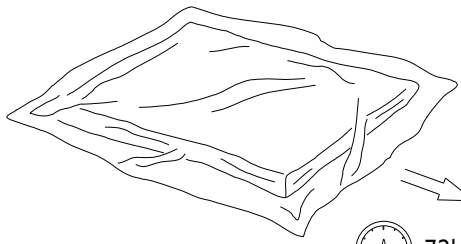

seat cushion insert
2 pcs

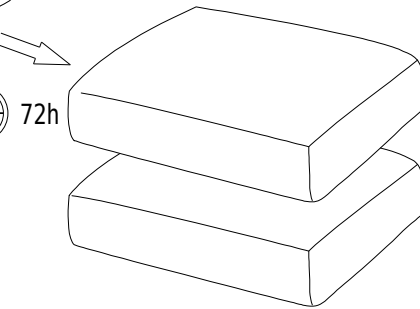

Unpacking

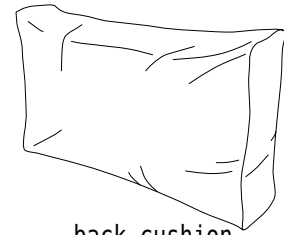

back cushion
3 pcs



lumbar pillow
2 pcs

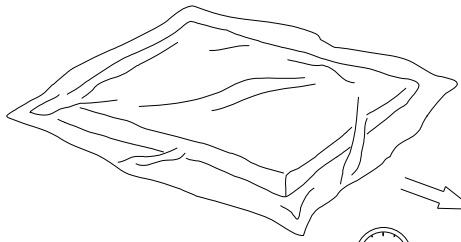

seat cushion insert
1 pcs

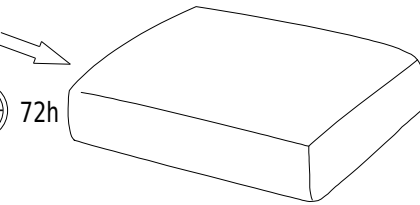

Unpacking

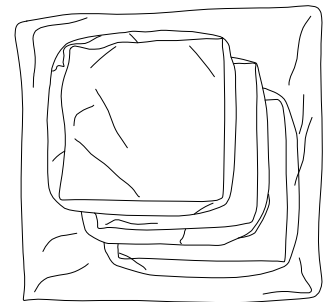

seat cushion cover
3 pcs

Step 1-1

D x 3, E x 3



R: screw M6*35mm
6 pcs

S: shim
ø16*6.4*1 6 pcs

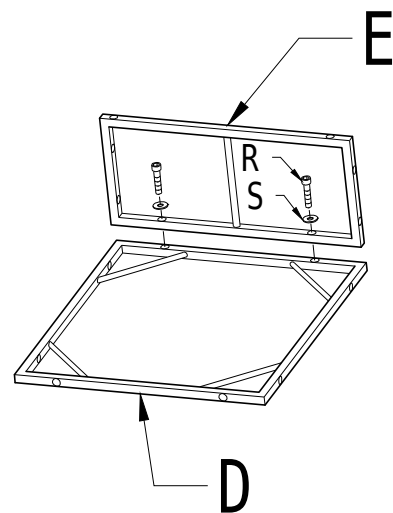
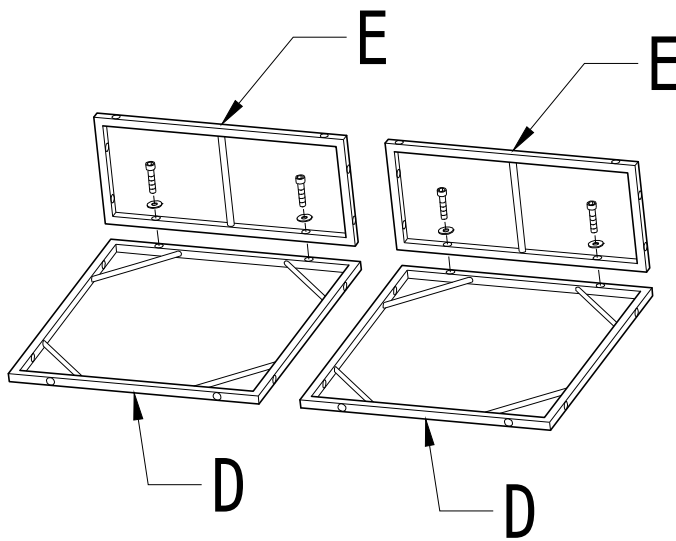

Step 1-2

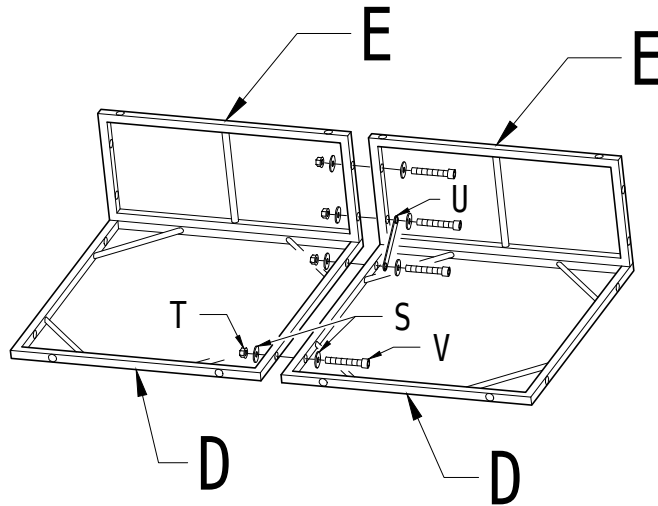
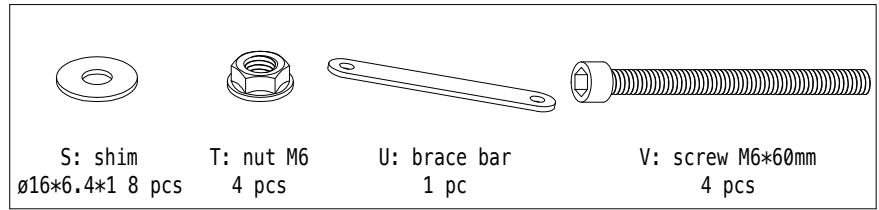

Step 2-1

C x 2

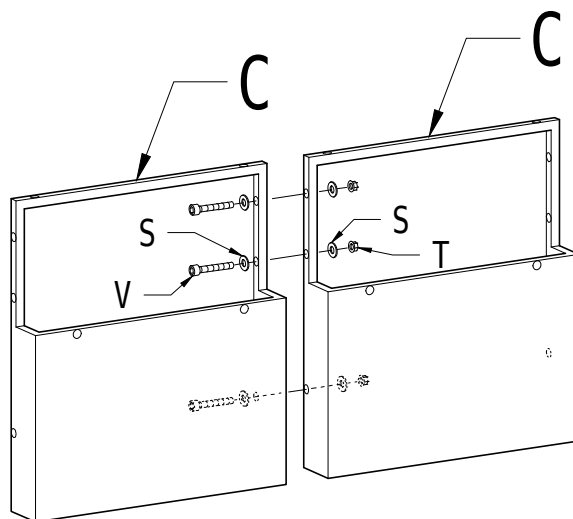
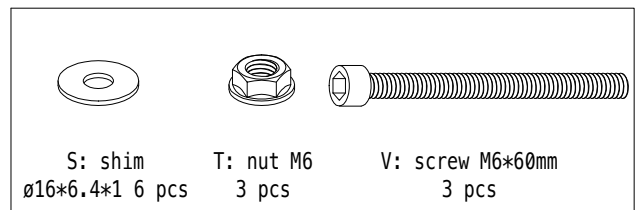

Step 2-2

C x 1



S: shim
ø16*6.4*1 12 pcs

T: nut M6
6 pcs

W: screw M6*50mm
6 pcs

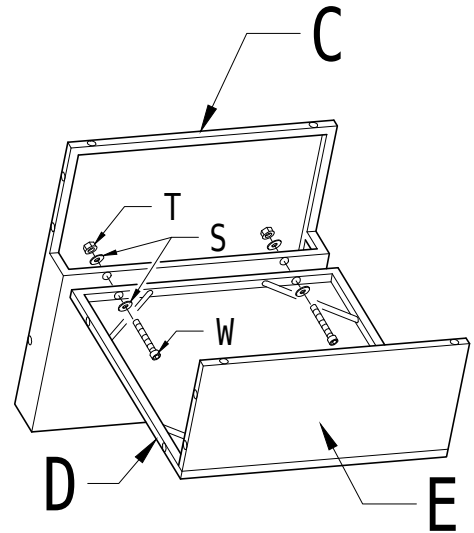
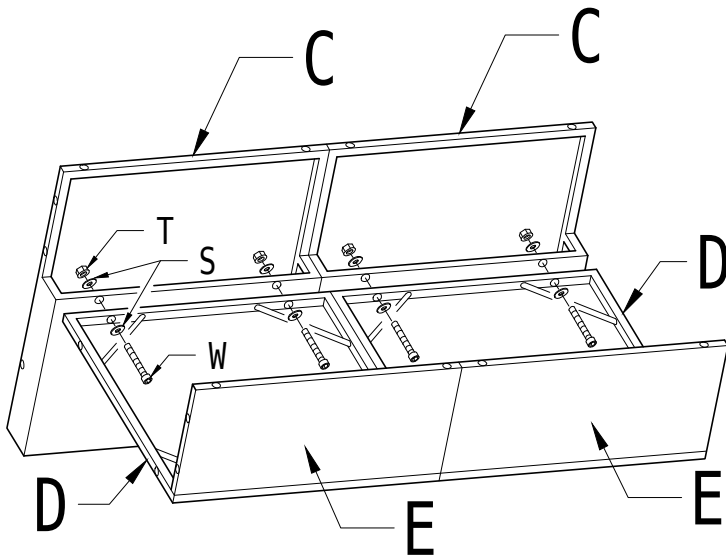

Step 3

A x 1



S: shim
ø16*6.4*1 14 pcs

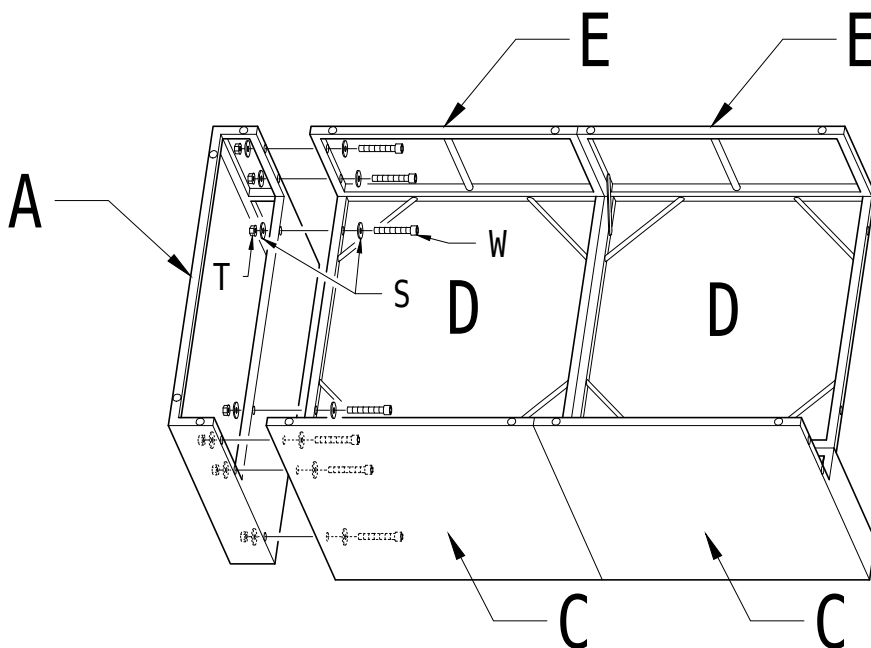

T: nut M6
7 pcs

W: screw M6*50mm
7 pcs





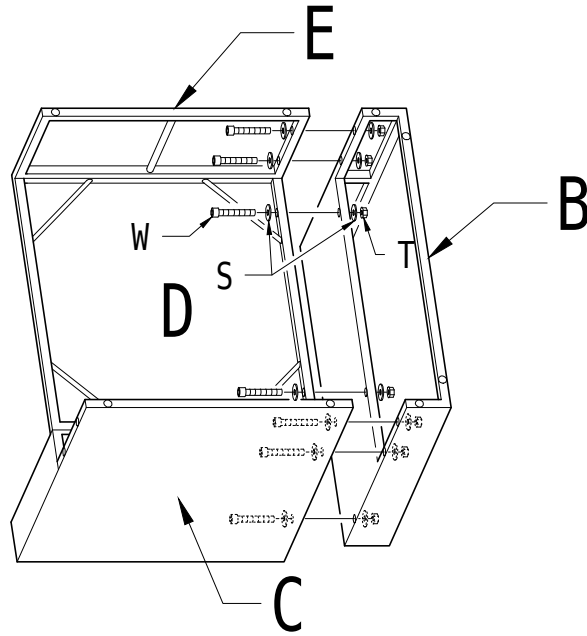

Step 4

B x 1

		
S: shim ø16*6.4*1 14 pcs	T: nut M6 7 pcs	W: screw M6*50mm 7 pcs



Step 5

			
S: shim ø16*6.4*1 14 pcs	T: nut M6 7 pcs	U: brace bar 1 pc	V: screw M6*60mm 7 pcs

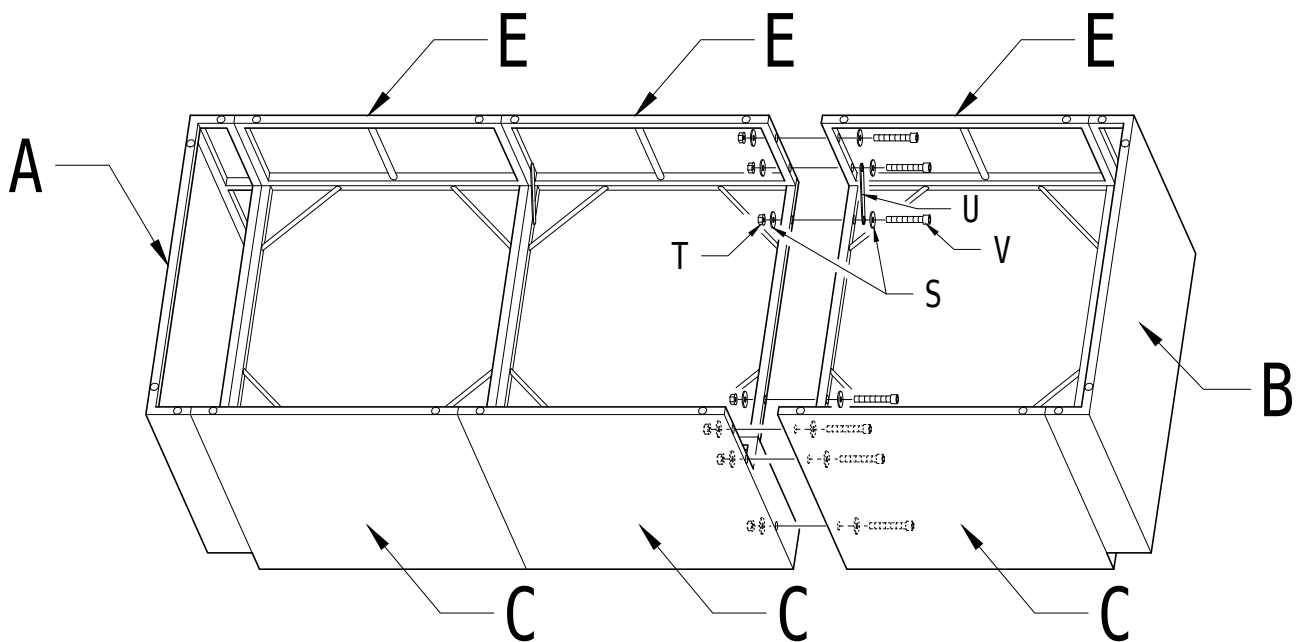

Step 6

