

# ASSEMBLY INSTRUCTION

ITEM NO.N715P297488

## Dining Chair

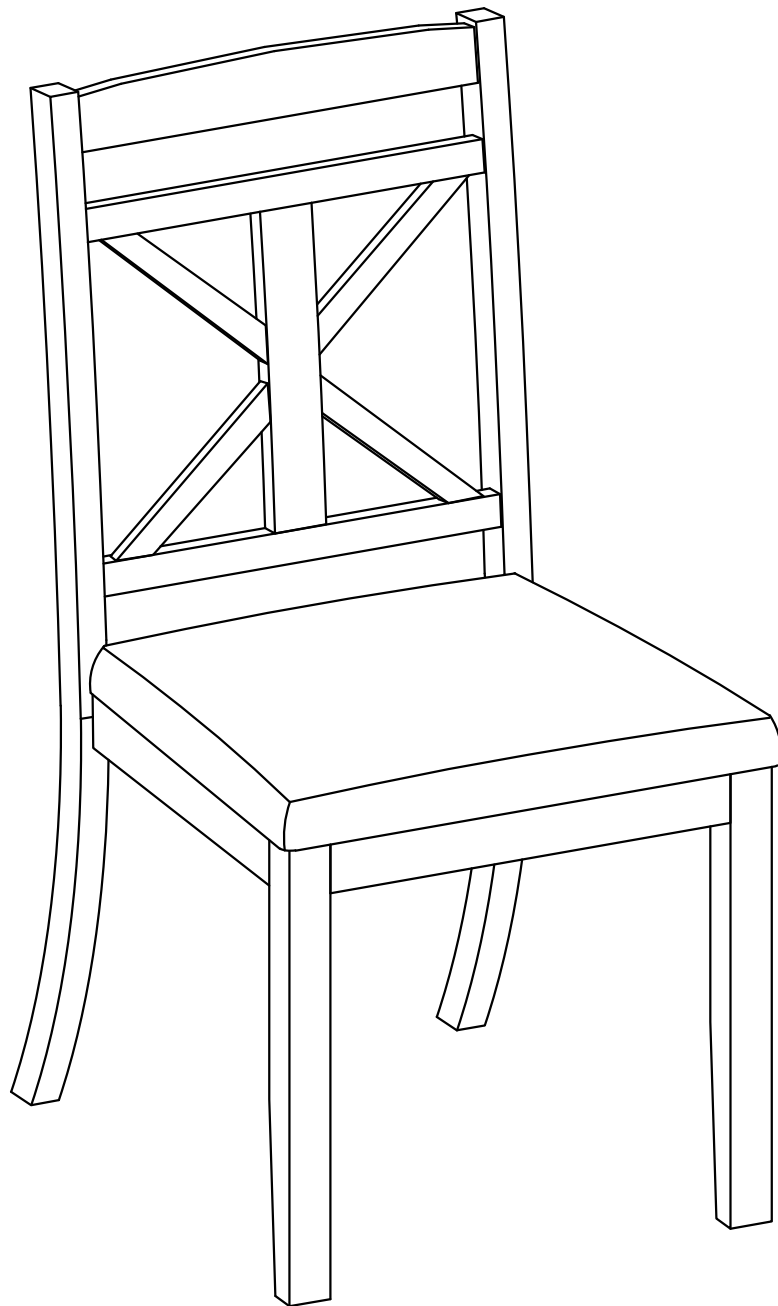

# ASSEMBLY INSTRUCTION

ITEM NO.N715P297488

Please read these instructions fully before starting assembly:

1. Place all wooden parts on a clean and smooth surface such as a rug or carpet to avoid scratching the parts.
2. Kindly follow the assembly instructions step by step.
3. Do not tighten all screws and bolts until the table is fully assembled.
4. Unscrew the protective plastique supports from the metal insert of the table legs before assembly.
5. Parts of the assembly will be easier with 2 people.

Care and maintenance:

Only clean using a damp cloth and mild detergent, do not use bleach or abrasive cleaners.

# ASSEMBLY INSTRUCTION

ITEM NO.N715P297488

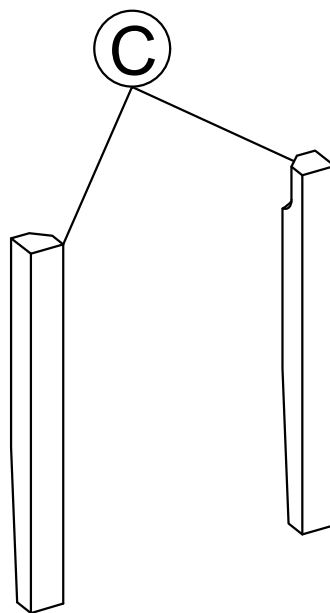
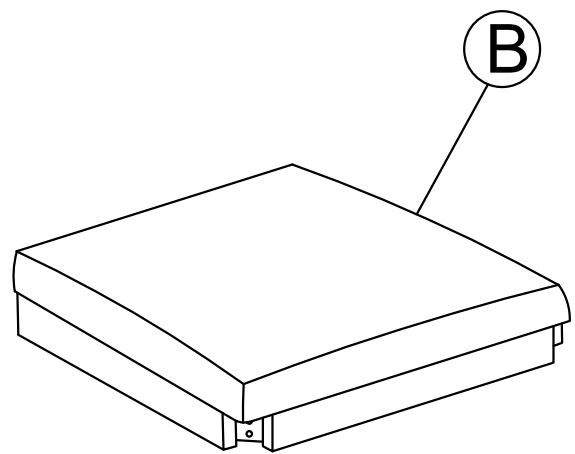
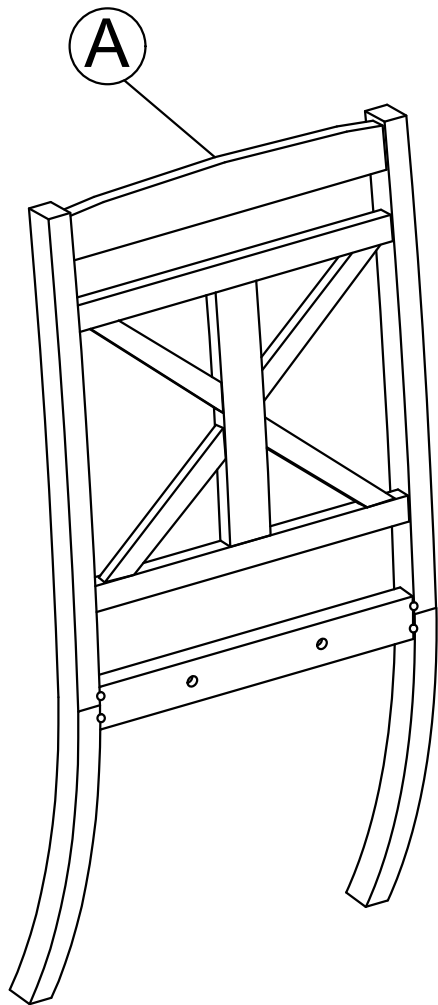

# ASSEMBLY INSTRUCTION

ITEM NO.N715P297488

## Part List For 4

(A)

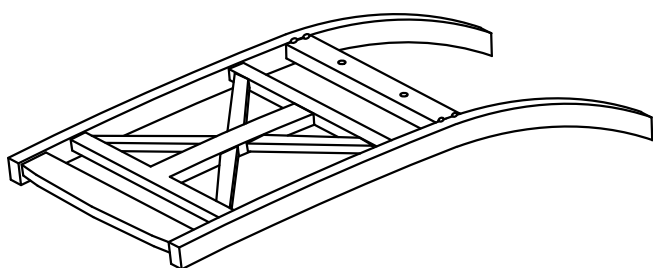

BACK CHAIR (4pcs)

(B)

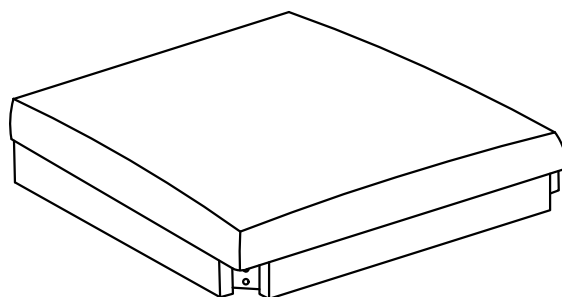

SEAT CHAIR (4pcs)

(C)

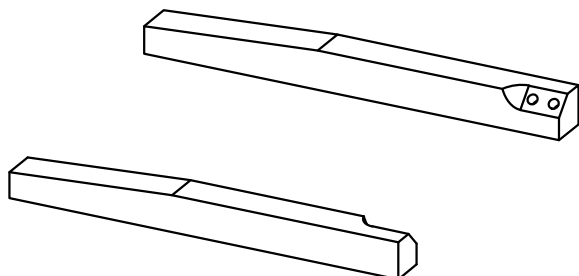

LEG FRONT (8pcs)

# ASSEMBLY INSTRUCTION

ITEM NO.N715P297488

## Hardware List For 4

①

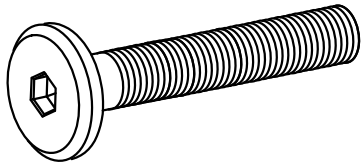

Ø1/4 " x 40mm

BOLT (8pcs)

②

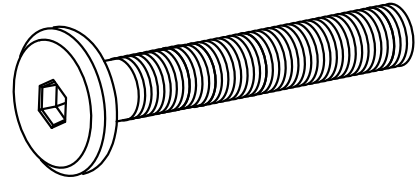

Ø1/4 " x 55mm

BOLT (16pcs)

③

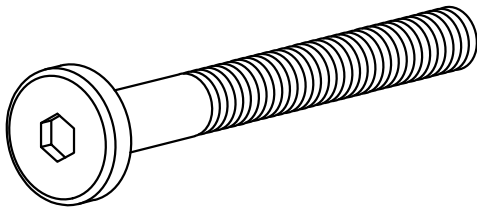

Ø1/4 " x 75mm

BOLT (16pcs)

④

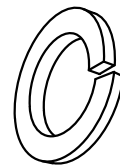

Ø5/16 " x 13mm

LOCK WASHER (40pcs)

⑤

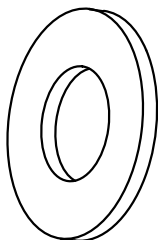

Ø5/16 " x 19 x 2 mm

FLAT WASHER (40pcs)

⑥



4 mm





ALLEN KEY (1pc)

# ASSEMBLY INSTRUCTION

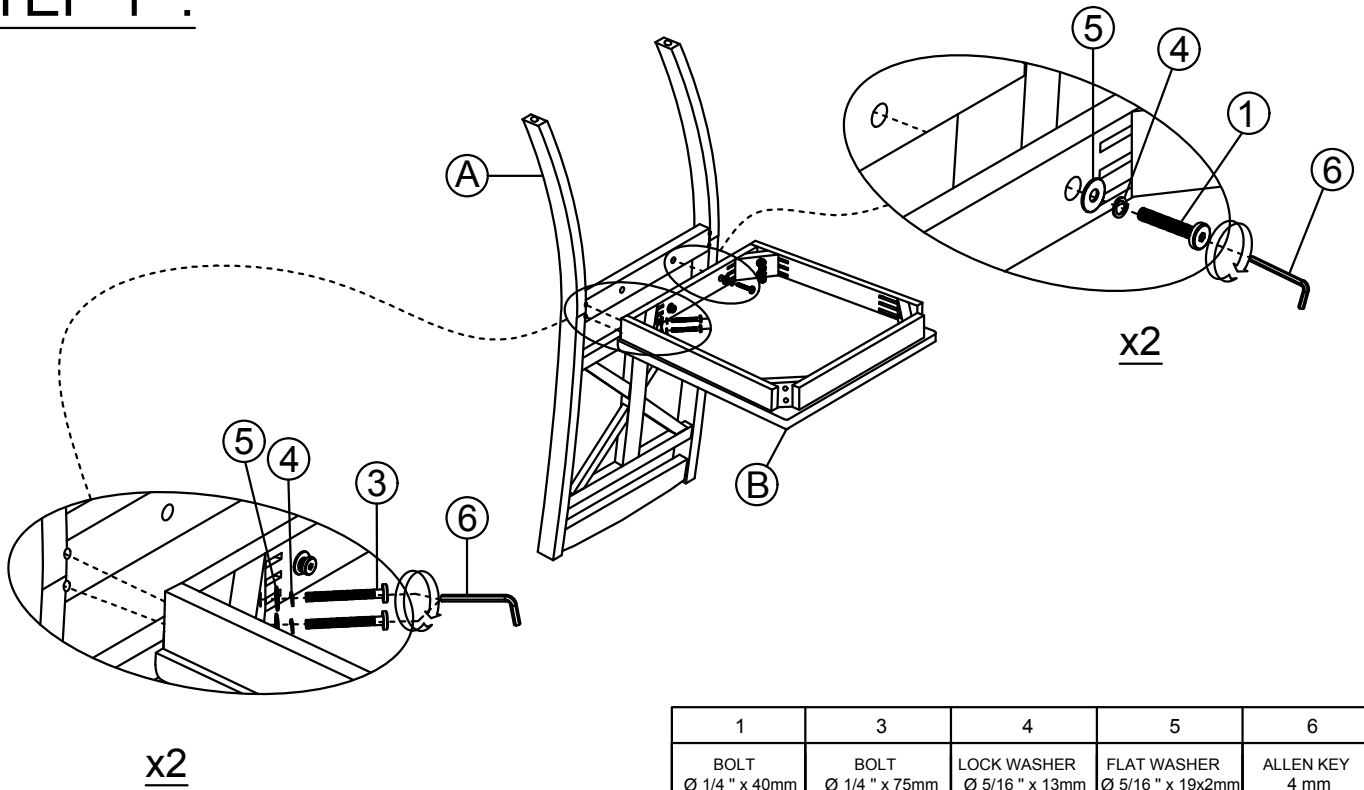
ITEM NO.N715P297488





## STEP 1 :

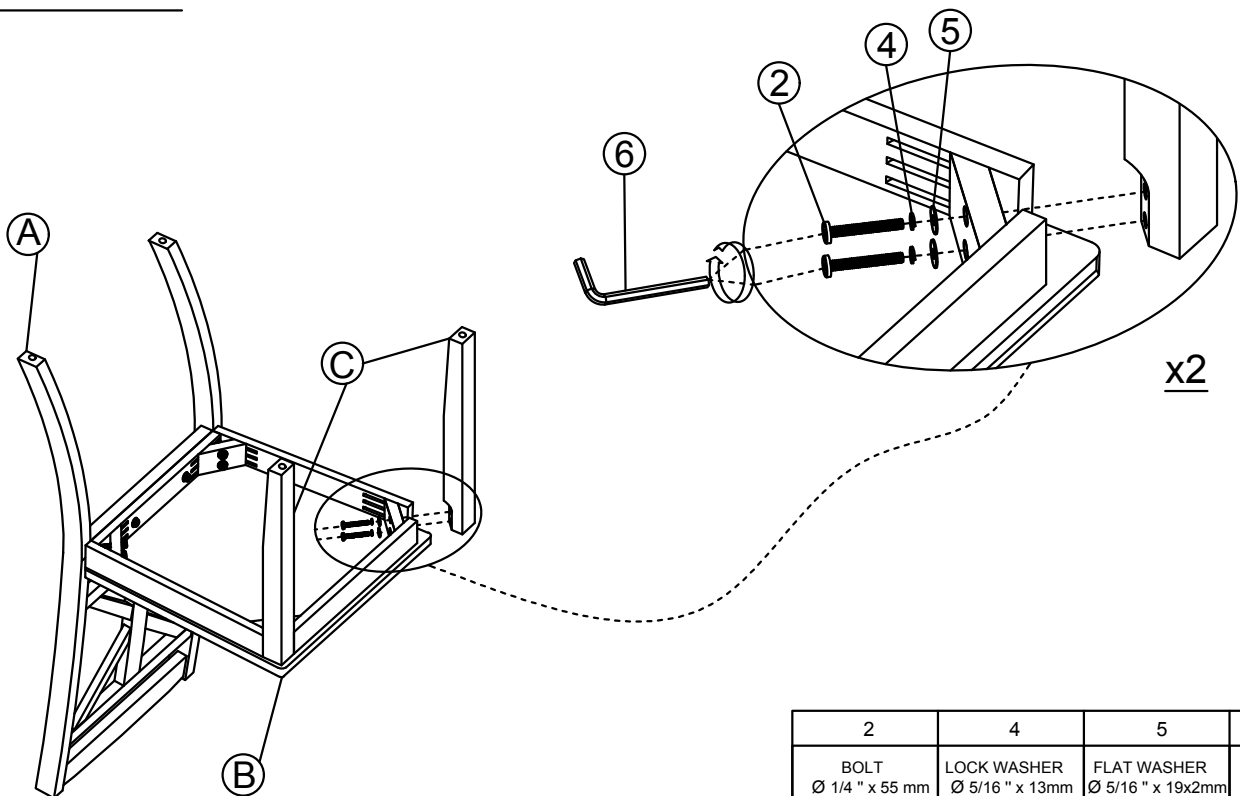

1	3	4	5	6
BOLT Ø 1/4 " x 40mm	BOLT Ø 1/4 " x 75mm	LOCK WASHER Ø 5/16 " x 13mm	FLAT WASHER Ø 5/16 " x 19x2mm	ALLEN KEY 4 mm
				
① x 2	③ x 4	④ x 6	⑤ x 6	⑥ x 1

## STEP 2 :



2	4	5	6
BOLT Ø 1/4 " x 55 mm	LOCK WASHER Ø 5/16 " x 13mm	FLAT WASHER Ø 5/16 " x 19x2mm	ALLEN KEY 4 mm
			
② x 4	④ x 4	⑤ x 4	⑥ x 1

# ASSEMBLY INSTRUCTION

ITEM NO.N715P297488

COMPLETE

