

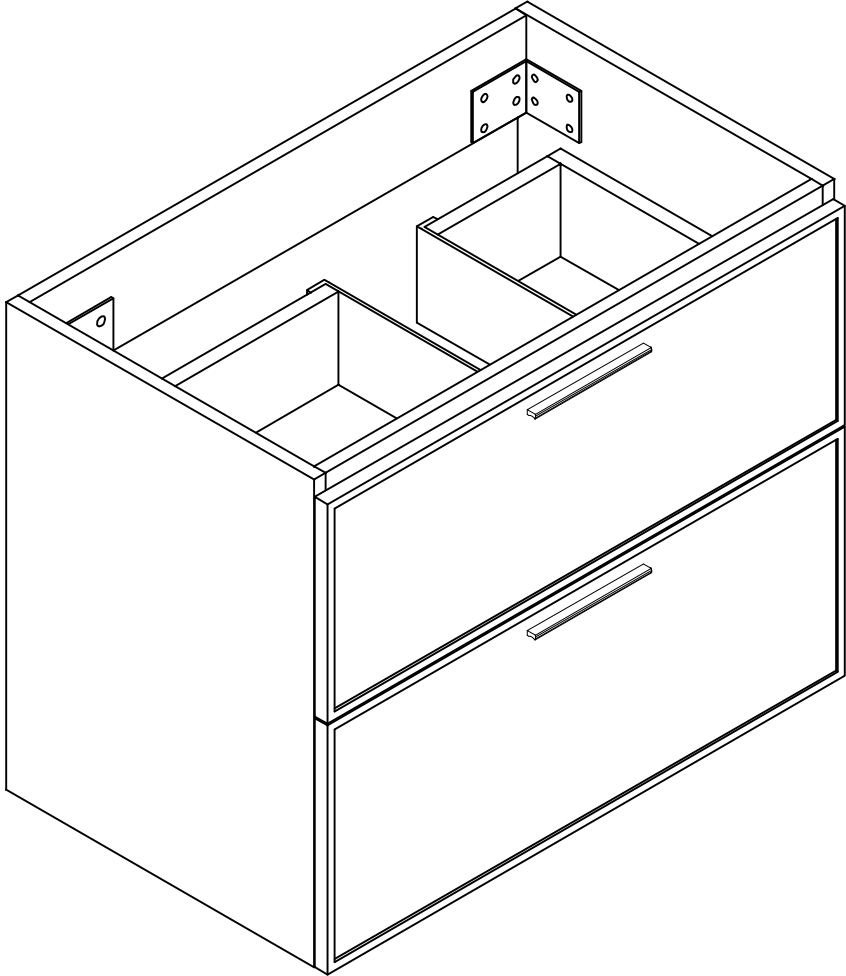

US42

# DIMENSIONS



## YOU MAY NEED (NOT SUPPLY)

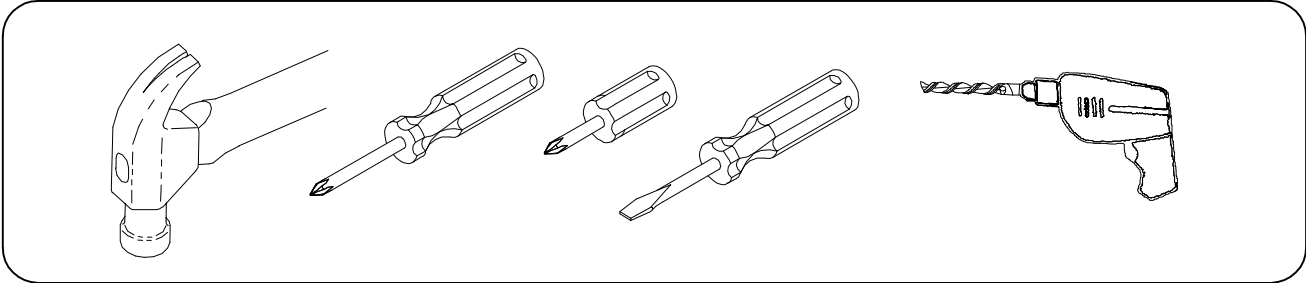



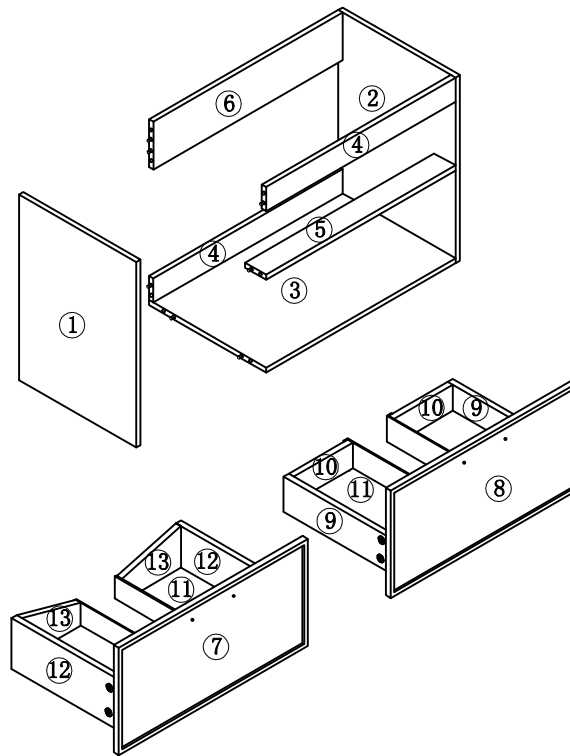







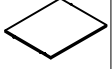

# ASSEMBLY DIAGRAM

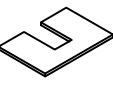











## PARTS LIST

### PARTS LIST

NO	DESCRIPTION	QTY	NO	DESCRIPTION	QTY
①	Left side panel 	1	⑧	Upper drawer front panel 	1
②	Right side panel 	1	⑨	Upper drawer side panel 	2
③	Bottom panel 	1	⑩	Upper drawer rear panel 	2
④	Long front and rear panel 	2	⑪	Drawers bottom panel 	2
⑤	Front middle panel 	1	⑫	Lower drawer side panel 	2
⑥	Upper back panel 	1	⑬	Lower drawer rear panel 	2
⑦	Lower drawer front panel 	1			

## PARTS LIST

### HARDWARE LIST



NO	DESCRIPTION	QTY	NO	DESCRIPTION	QTY
A	Three-in-one eccentric wheel 	42	G	4*23mm screw 	4
B	Three-in-one connecting rod 	42	H	Drawer handle 	2
C	Three-in-one sticker 	42	I	White angle bracket 	2
D	8*40mm wood dowel pins 	22	J	Drawer U-shaped plastic 	2
E	Drawer slides 	4			
F	4*16mm screw 	60			

### CAUTION:

Please confirm the parts list before installation

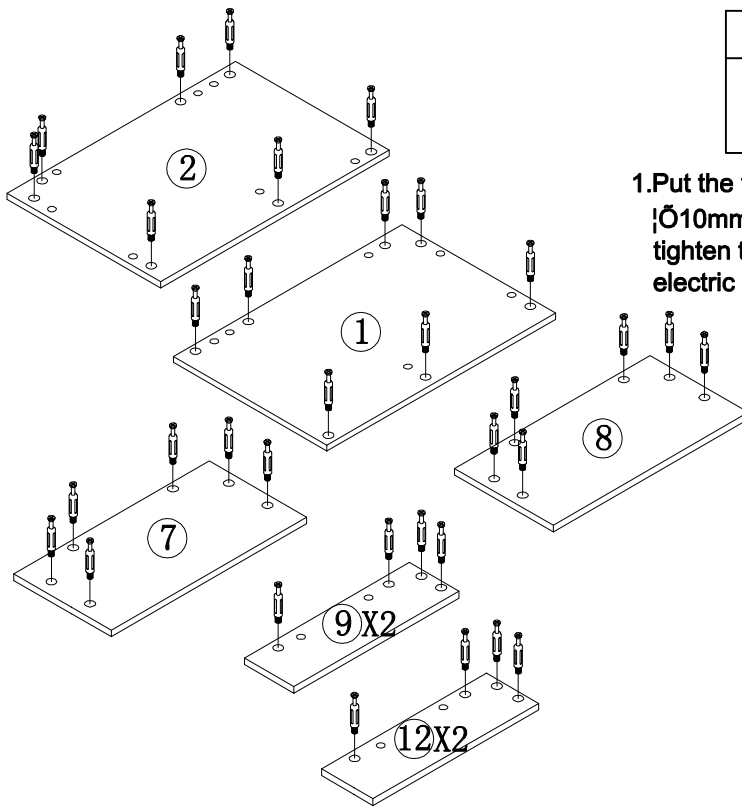
# STEP 1



HARDWARE LIST	
Three-in-one connecting rod B  42 PCS	

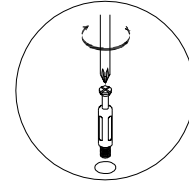

1. Put the three-in-one connecting rod in the  $\varnothing 10\text{mm}$  hole of the following panels and tighten them with a cross screwdriver or an electric tool.

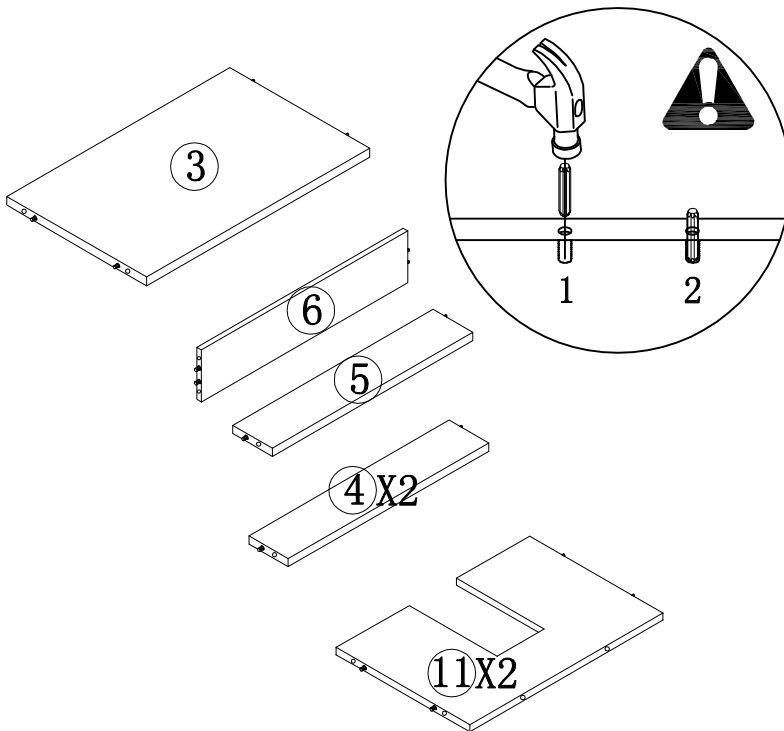

# STEP 2





1. Strike the  $\varnothing 8 \times 40\text{mm}$  wood dowel pin into the  $\varnothing 8\text{mm}$  hole of the above panels with an iron hammer. Please note that the hole of the three-in-one connecting rod should also be 8mm. The hole of the three-in-one connecting rod connects to the hole of  $\varnothing 15\text{mm}$  three-in-one eccentric wheel.

HARDWARE LIST	
8*40mm wood dowel pins D  22 PCS	

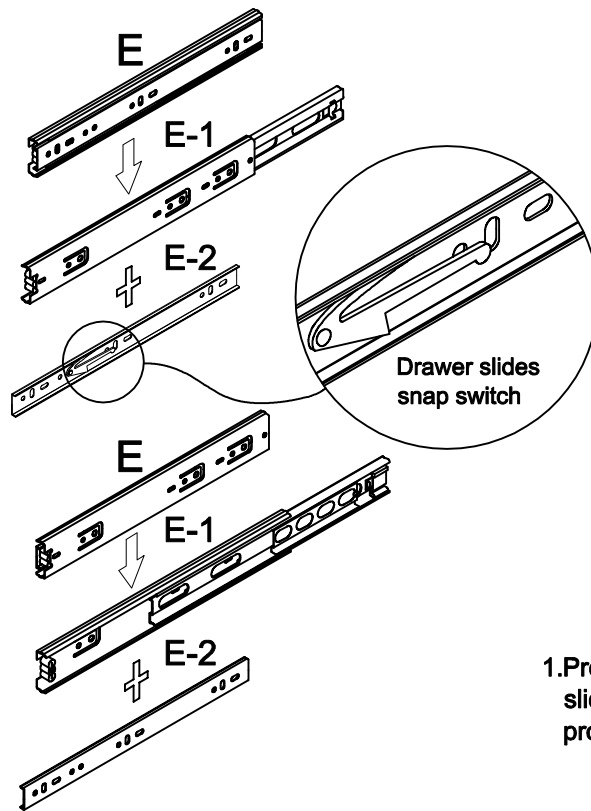
# STEP 3





HARDWARE LIST	
Drawer slides	
E  4 PCS	

1. Press the slide snap switch, disassemble slide blocks and put them in a place properly for further use.

# STEP 4

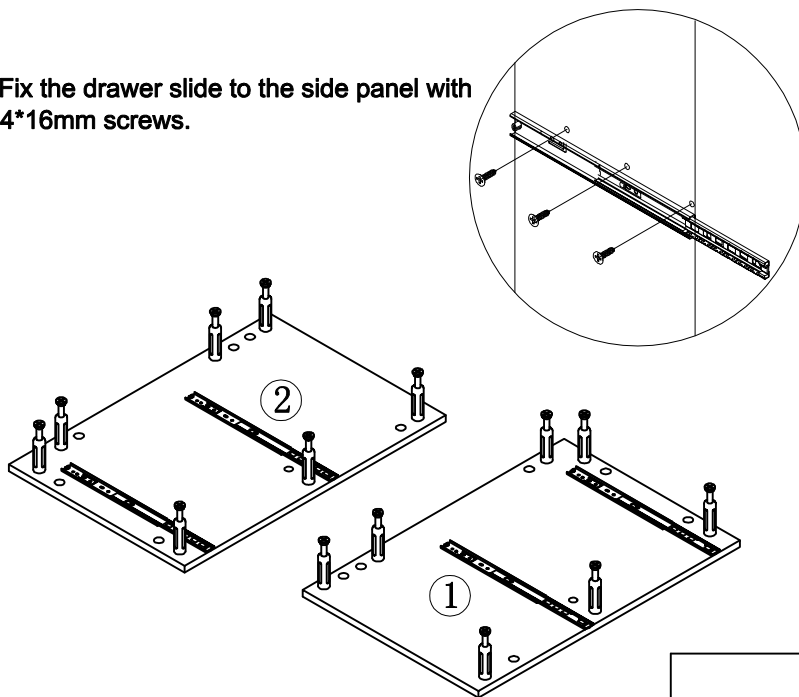
1. Fix the drawer slide to the side panel with 4\*16mm screws.

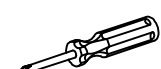

HARDWARE LIST		
4*16mm screw	Drawer slides	
F  12 PCS	E-1  4 PCS	

# STEP 5

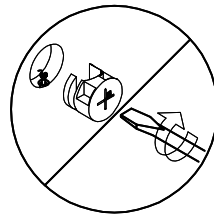
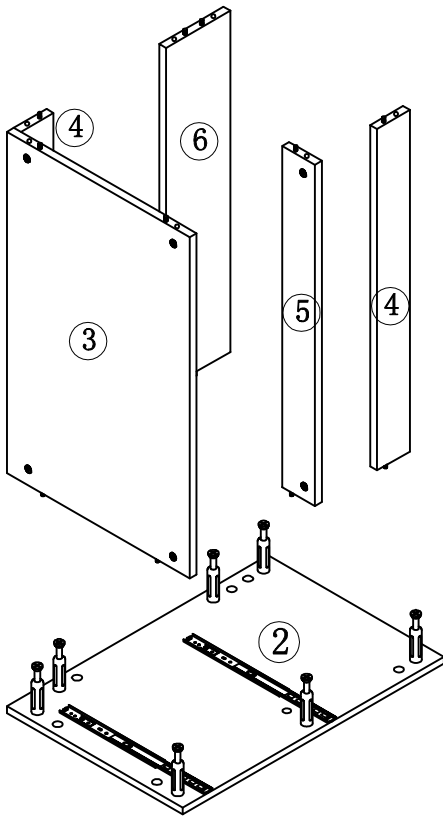

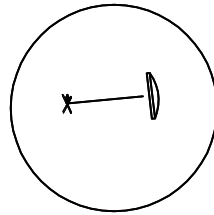

1. Connect No. 3-4-5-6 panel to No.2 panel tightly with the three-in-one eccentric wheel.



2. Cover the mounting hole of the eccentric wheel with a three-in-one sticker.

## HARDWARE LIST

Three-in-one eccentric wheel A  7 PCS	Three-in-one sticker C  7 PCS	
--	--	--

# STEP 6

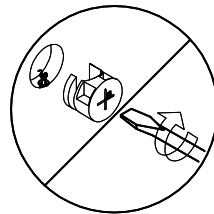
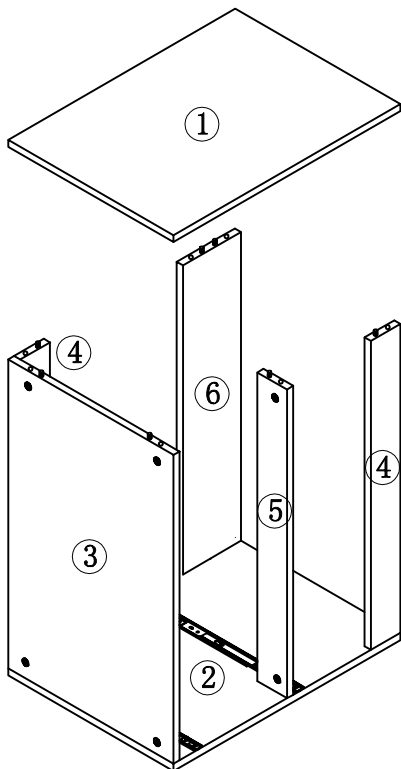

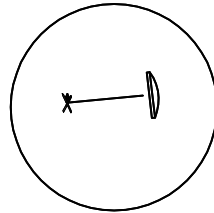

1. Connect No. 1 panel to No. 3-4-5-6 panel tightly with the three-in-one eccentric wheel.



2. Cover the mounting hole of the eccentric wheel with a three-in-one sticker.

## HARDWARE LIST

Three-in-one eccentric wheel A  7 PCS	Three-in-one sticker C  7 PCS	
---	---	---

# STEP 7

1. Install the Drawer U-shaped plastic with 4\*16mm screws.

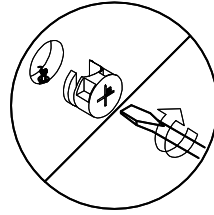
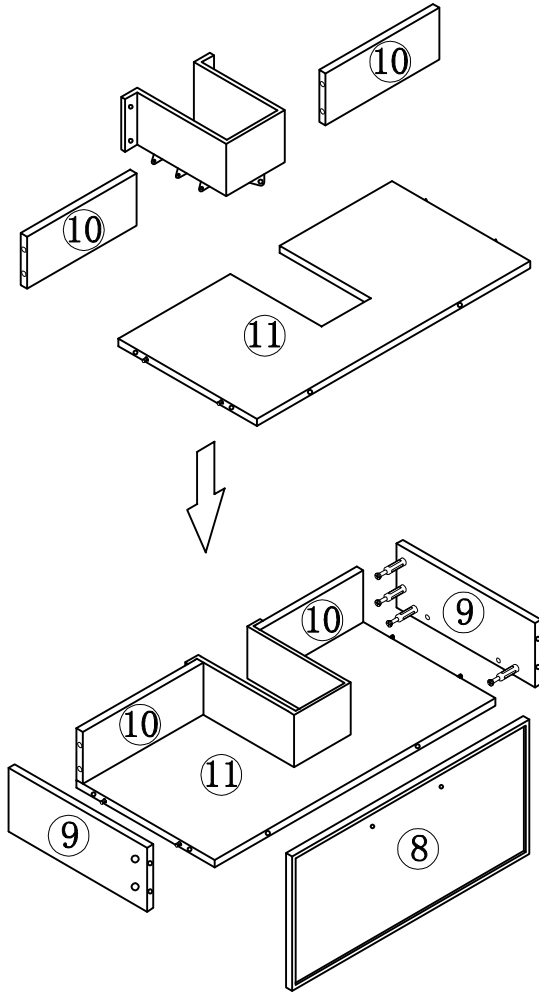



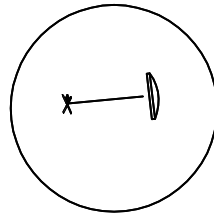

1. Install No. 8-9-10-11 panels with the three-in-one eccentric wheel tightly.

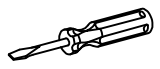

2. Cover the mounting hole of the eccentric wheel with a three-in-one sticker.

## HARDWARE LIST

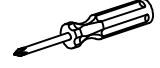

Three-in-one eccentric wheel A  14 PCS	Three-in-one sticker C  14 PCS	
Drawer U-shaped plastic J  1 PCS	4*16mm screw F  10 PCS	

# STEP 8

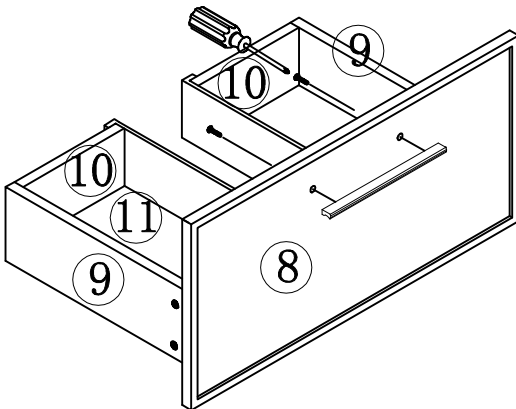
1. Install the drawer handle with 4\*23mm screws.

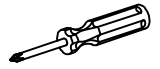

## HARDWARE LIST

4*23mm screw G  2 PCS	Drawer handle H  1 PCS	
---	--	---

# STEP 9

1. Install the Drawer U-shaped plastic with 4\*16mm screws.

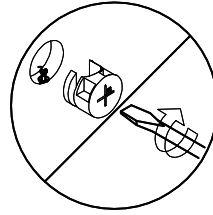
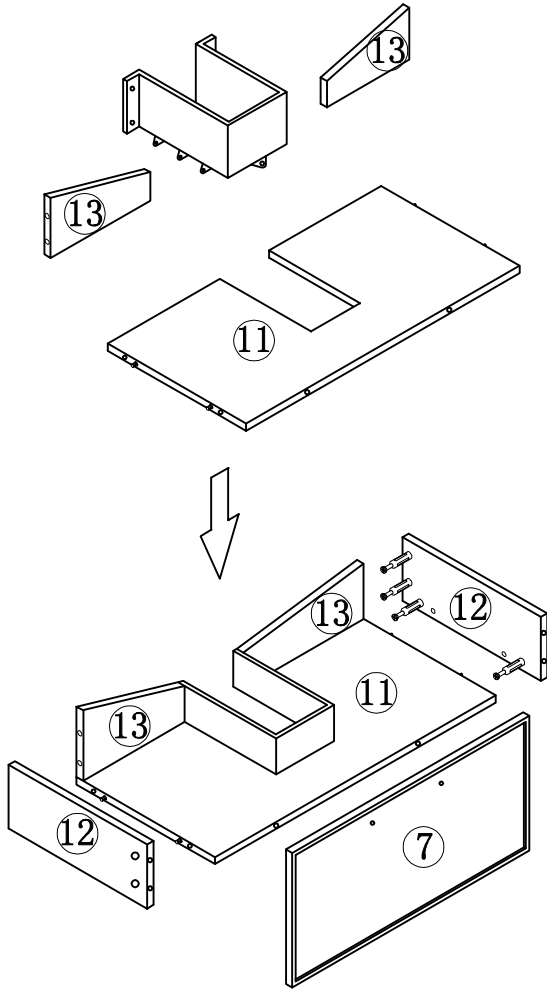



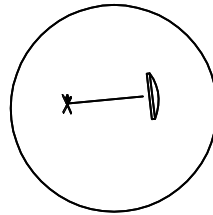

1. Install No. 7-11-12-13 panels with the three-in-one eccentric wheel tightly.

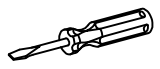

2. Cover the mounting hole of the eccentric wheel with a three-in-one sticker.

## HARDWARE LIST

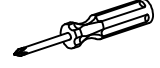

Three-in-one eccentric wheel A  14 PCS	Three-in-one sticker C  14 PCS	
Drawer U-shaped plastic J  1 PCS	4*16mm screw F  10 PCS	

# STEP 10

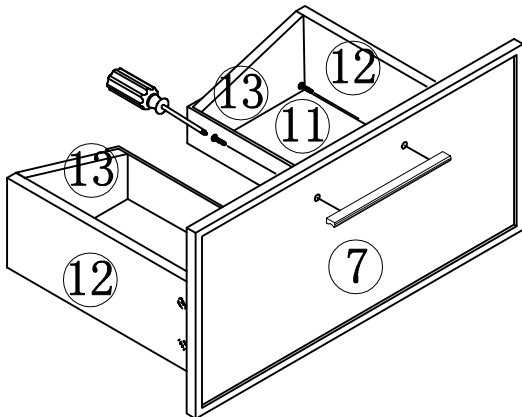
1. Install the drawer handle with 4\*23mm screws.



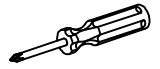

## HARDWARE LIST

4*23mm screw G  2 PCS	Drawer handle H  1 PCS	
---	--	---

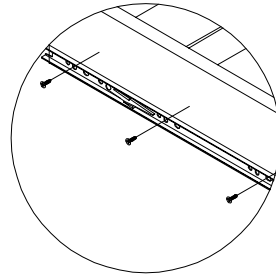
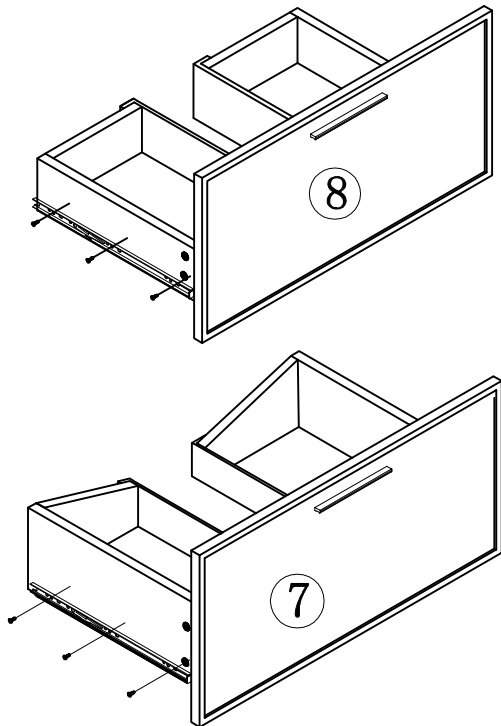
# STEP 11

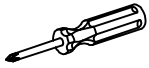

1.Lock the spare drawer slide block to the drawer.

HARDWARE LIST		
4*16mm screw	Drawer slides	
F  12 PCS	E-2  4 PCS	

# STEP 12

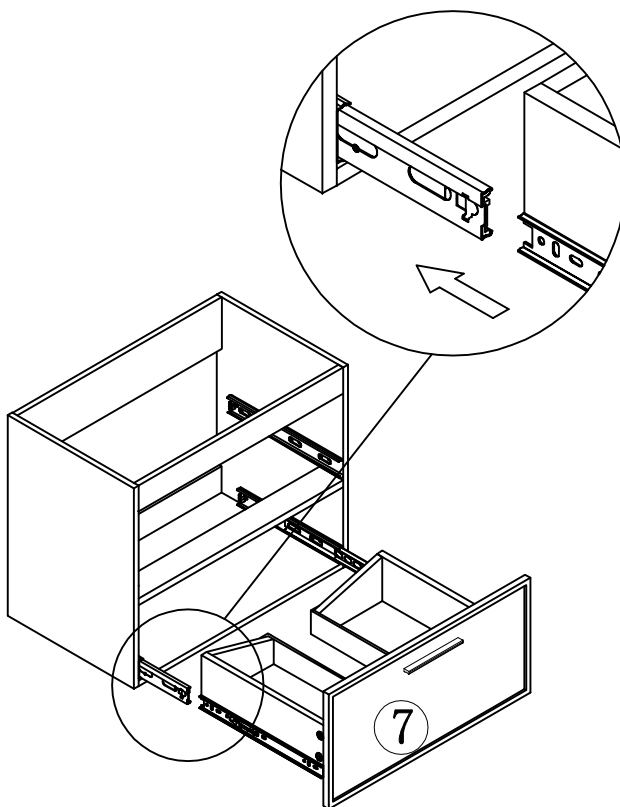

1.Align slide block with the trough on the guide rail, press the snap switch and press it forward to install the drawer.

## STEP 13

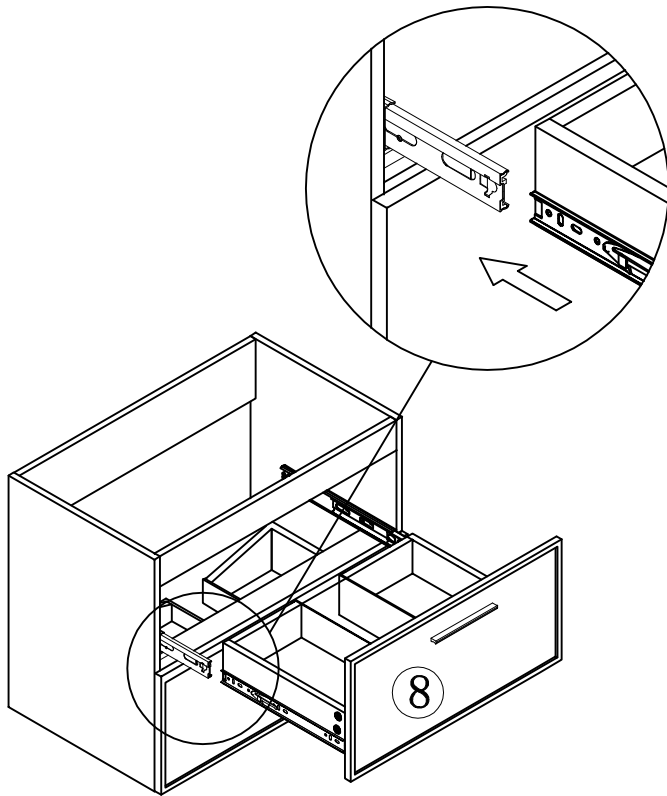

1. Align slide block with the trough on the guide rail, press the snap switch and press it forward to install the drawer.

## STEP 14

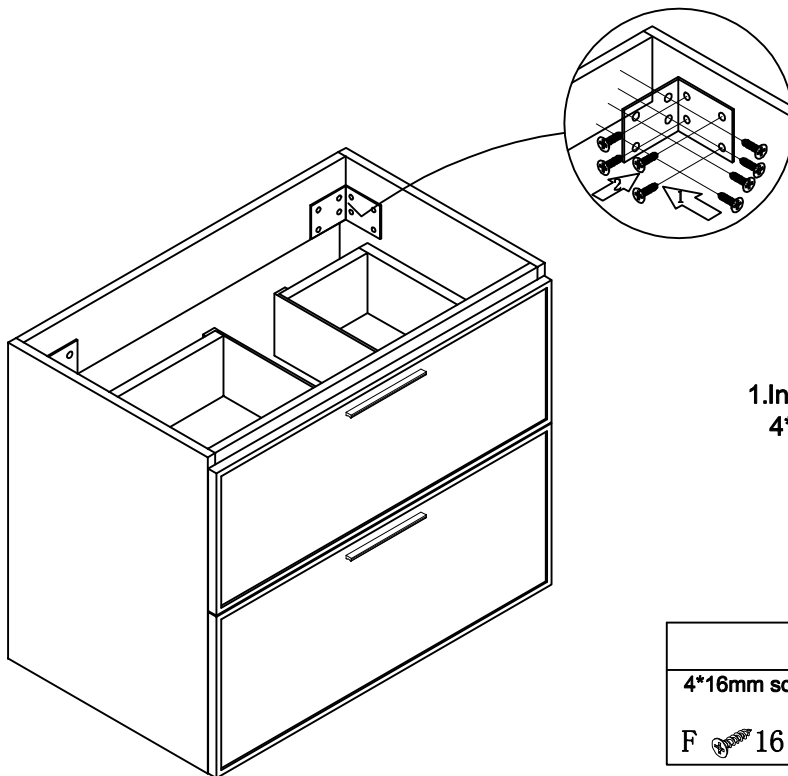

1. Install white angle bracket with 4\*16mm screws.

### HARDWARE LIST

4\*16mm screw

White angle bracket

F  16 PCS

I  2 PCS

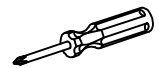



**Choking hazard-Small Parts :** This unit contains small parts, not for children under 3 years.

**Tip-over hazard :** Secure finished unit to wall stud using L-Bracket and wall screw (#10\*1.5"W/out provided). If a wall stud is not neccessible , Consault your local hardware store for appropriate mounting hardware . Failure to properly install will result in product collapse or tip-over. Serious injury can occur .